



1 Company Profile



▶ 5

1 New products



▶ 13

2 Single foot switches - PA-PX series

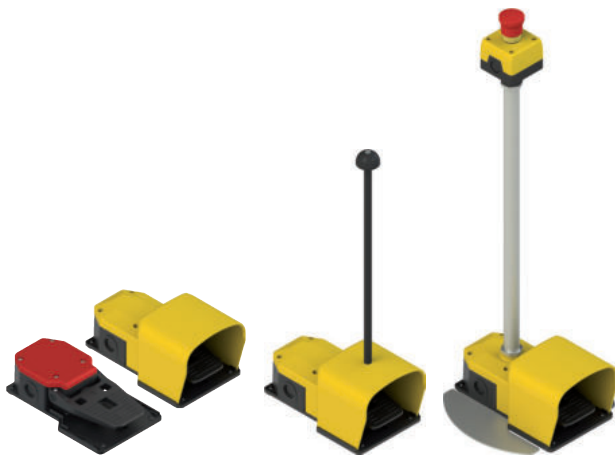

▶ 15

3 Modular foot switches - PC series

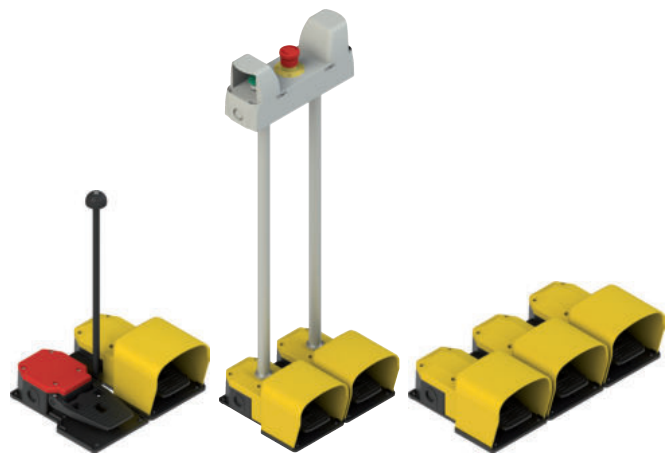

▶ 23

4 E2 PU-PL series single buttons



▶ 33

5 E2 PD-PT series double and triple buttons



▶ 41

6 E2 PQ series quadruple buttons



▶ 47

7 E2 PE series emergency stop buttons



▶ 51

8 E2 SE-SL series selector switches

▶ 57

9 E2 SC series key selector switches

▶ 69

10 E2 MA series joysticks

▶ 77

11 E2 IL series indicator lights

▶ 83

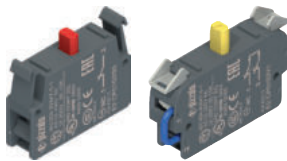
12 E2 CP-CF series single contact blocks

▶ 87

13 E2 CP-CF series double contact blocks

▶ 95

14 E2 LP-LF series LED units

▶ 99

15 Protected contact blocks - FR, FK, FX series

▶ 105

16 E2 series RJ45 and USB sockets

▶ 111

17 E6 DM series potentiometers

▶ 115

18 Monolithic indicator lights - E6 IL series

▶ 119

19 Buzzers series E6 IS

▶ 123

20 ES series housings

▶ 127

21 EA series housings

▶ 137

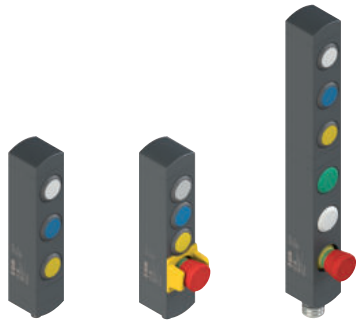
22 BN series control device units

▶ 143

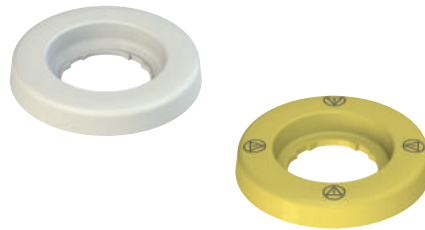
23 VE DL series luminous discs

▶ 157

24 Accessories EROUND line

▶ 161

25 Utilization requirements

Utilization requirements for EROUND line ▶ 169
 Utilization requirements for
 PA, PX, PC series foot switches ▶ 172

26 Accessories

▶ 173

27 Appendix

Contact blocks ▶ 193
 Assembled connectors ▶ 194
 Technical definitions ▶ 195
 General terms and conditions of sale ▶ 199



MORE THAN 300 PROFESSIONALS WITH PASSION

It is people, with their professionalism and dedication that make a great company. This profound conviction has always guided Pizzato Elettrica in their choice of employees and partners.

Today, Giuseppe and Marco Pizzato lead a tireless team providing the fastest and most efficient response to the demands of the market. This team has grown over the last 10 years and has achieved a considerable increase in sales in all the countries where Pizzato Elettrica is present.

The various strategic sectors of the business are headed by professionals with significant experience and expertise. Many of these people have developed over years with the company.



Others are experts in their specific field and have integrated personal experience with the Pizzato Elettrica ethos to extend the company's capability and knowledge.

From the design office to the technical assistance department, from managers to workers, every employee believes in the company and its future. Pizzato Elettrica employees all give the best of themselves secure in the knowledge they are the fundamental elements of a highly valuable enterprise.



100% MADE IN ITALY

Pizzato Elettrica is one of the leading European manufacturers of position switches, microswitches, safety devices, safety modules, foot switches, control and signalling devices, and devices for lifts. An entrepreneurial company such as Pizzato Elettrica bases its foundations on a solid and widely shared value system. The pillars that form the basis of the company's work have remained constant, and constitute the fundamental guiding principles for all company activities.

PASSION FOR QUALITY

Passion for product quality, orientation towards excellence, innovation, and continuous development, represent the key principles of Pizzato Elettrica's everyday work.

Anyone using Pizzato Elettrica's products does so in the certainty that these devices are of certified quality, since they are the result of a process that is scrupulously controlled at every stage of the production.

The company's goal is to offer the market safe, reliable, and innovative solutions.

CARE FOR THE CUSTOMER

In order to be successful, a product must respond to the specific needs of those who will use it. Market developments must be carefully monitored in order to understand, in advance, which new applications will prove themselves truly useful. This is why Pizzato Elettrica has always cultivated close synergies with the companies that have chosen it

as a supplier, using this continuous dialogue to identify the potential developments of the own product range in order to make it highly flexible, complete and capable to respond to the most diverse needs.

100% MADE IN ITALY

All Pizzato Elettrica products are designed, developed, and tested entirely at the company plants in Marostica, in the province of Vicenza in Italy. The company is thus able to meet specific customer requirements at all times, by offering a comprehensive range of products and technologically advanced solutions.

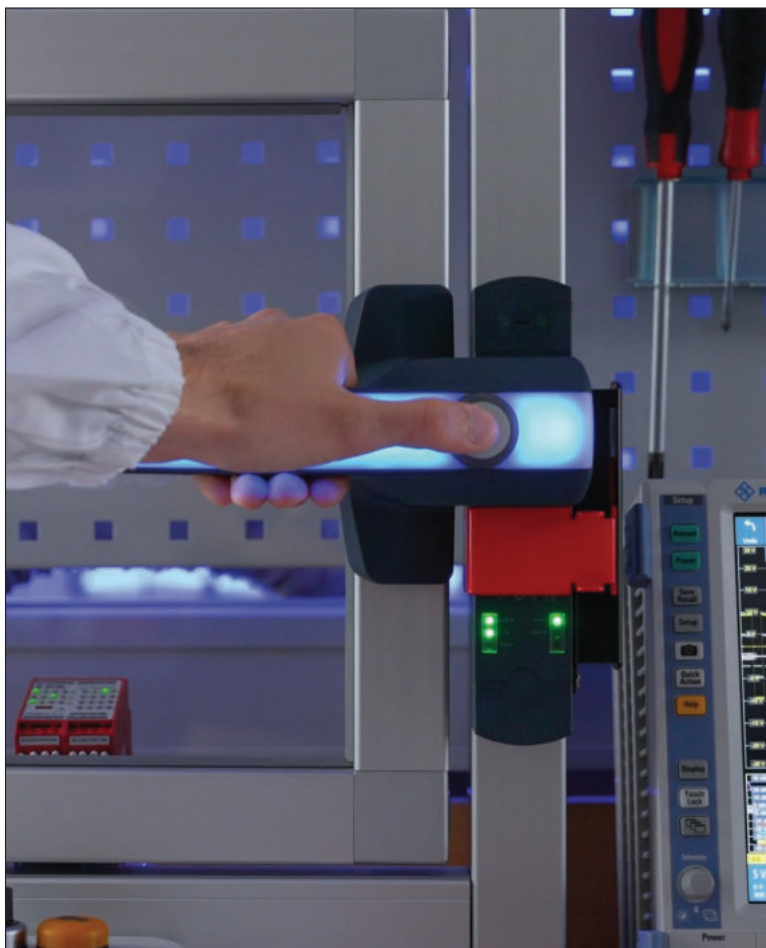



1984: AN ENTREPRENEURIAL STORY BEGINS

- 1984** The company Pizzato di Pizzato B. & C. snc. manufacturer of position switches is founded.
- 1988** The company becomes a limited liability partnership, and is renamed Pizzato Elettrica, a brand shortly destined to become renowned and valued nationwide. The first company-owned plant (P1) geared towards mechanical processing was built.
- 1990** By the end of the decade, thanks to the development of quality products and the experience built on the Italian market, Pizzato Elettrica turns to the international market.
- 1995** Building of the second plant (P3) geared towards the moulding of plastic materials. Development of the position switch range continues in parallel. Start of significant years in terms of safety devices planning. The safety sector becomes a key sector to the company.
- 1998** Construction of the third plant (P4), housing the assembly department.
- 2002** Achievement of the ISO 9001:2000 certification. Launching of the first safety modules. The new factory headquarters and logistics centre (P5) is built and will remain the company's headquarters for many years. Continued expansion of the industrial safety and automation product range.
- 2007** Pizzato Elettrica faces its first generational change: Giuseppe and Marco Pizzato take over the company directorship.
- 2010** Extension of Pizzato Elettrica product portfolio, with the launch of the innovative EROUND line consisting of control and signalling devices. This product range accompanies position switches and safety devices, thus offering complete solutions to customers.
- 2012** Introduction of Gemnis Studio, the first software produced by Pizzato Elettrica. A graphic development environment for the creation, simulation, and debugging of programs that can be integrated in the Gemnis line modules.
- 2013** Foundation of first subsidiary of Pizzato Elettrica, Pizzato Deutschland GmbH, in Germany.
- 2014** A new production facility (P8) dedicated to switches and automatic machines is opened, spanning a surface area of 6000 m².
- 2016** The new NS series of safety switches with electromagnets and RFID technology is introduced, fruit of the company's experience, spanning more than thirty years in the field of industrial safety. To date it is the state of the art in its industry. Foundation of second subsidiary of Pizzato Elettrica, Pizzato France SARL, in France.
- 2017** The company continues to expand and achieves the quality certification based on the more recent version of standard ISO 9001 of 2015. In Spain, the third Pizzato Elettrica subsidiary is founded: Pizzato Iberica SL. The foundation stone is laid for the new factory (P6), which is to become the company's headquarters.
- 2018** The safety handle P-KUBE Krome is launched, a brand new product in the market, confirming that Pizzato Elettrica thrives on innovation in the sectors of automation and industrial safety. Foundation of fourth subsidiary of Pizzato Elettrica, Pizzato USA Inc, in the United States.
- 2019** The new factory (P6) is opened, a modern building of 28,000 m² realized with the most advanced Industry 4.0 technologies, where all offices and production divisions are transferred, allowing to further improve the flow of material and information. The logistics and shipment department is optimised with the introduction of a new completely automated warehouse.
- 2021** Pizzato Elettrica India Ltd. and Pizzato Korea Ltd., commercial branches of Pizzato Elettrica, are established in India and South Korea, respectively.
- 2022** Foundation of Pizzato Academy, Pizzato Elettrica's new training site for getting better acquainted with our products and following the constant regulatory developments in the sector.
- Today**, Giuseppe and Marco Pizzato lead a company in constant growth in terms of new product launches, number of employees, turnover, and new markets. Pizzato Elettrica is continuing its new product internationalisation and development process.



100 MILLION PARTS SOLD WORLDWIDE

Pizzato Elettrica's product catalogue contains more than 10,000 articles, with more than 1,500 special codes developed for devices personalised according to clients' specific needs. Pizzato Elettrica devices can be grouped, according to typology, into three main macro-categories.

POSITION SWITCHES

Pizzato Elettrica position switches are daily installed in every type of industrial machinery all over the world for applications in the sector of wood, metal, plastic, automotive, packaging, lifting, medicinal, naval, etc.

In order to be used in a such wide variety of sectors and countries, Pizzato Elettrica position switches are made to be assembled in a lot of configurations thanks to the various body shapes, dozens of contact blocks, hundreds of actuators and materials, forces, assembling versions.

Pizzato Elettrica can offer one of the widest product range of position switches in the world. Moreover, the use of high quality materials, high reliability technologies (e.g. twin bridge contact blocks) as well as the IP67 protection degree make this range of position switches one of the most technologically evolved.

SAFETY DEVICES

The company Pizzato Elettrica has been one of the first Italian companies developing dedicated items for this sector, creating and patenting dozens of innovative products, thus becoming one of the main European manufacturers of safety devices.

The vast range of products aimed specifically at the safety of machinery, fully designed and assembled at the Marostica (VI) company premises, includes not only more traditional safety switches with separate actuator (with or without locking mechanism) and hinge switches but also state-of-the-art anti-tampering devices with RFID technology, such as the ST series sensors, and NG and NS series locking devices.

The product range is complemented by safety handles for guards, with the innovative P-KUBE Krome model whose grip can be illuminated with multicolour signalling LEDs, as well as by the CS series safety modules, available in single function versions, or user-programmable with the use of the Gemnis Studio software; fully implemented by Pizzato Elettrica and distributed with a free licence.

MAN-MACHINE INTERFACE

Pizzato Elettrica's control and signalling devices of the EROUND line are designed for the use in the human-machine interface sector. Thanks to the elegant design, the care for details and the elegance of the product combined with its maximum safety and reliability, this series is one of the most complete and cutting-edge on the market.

In order to satisfy its customers' needs and requests, Pizzato Elettrica offers a lot of accessories purposely designed not only to complete its wide range of products, but also to help device installation on machineries.



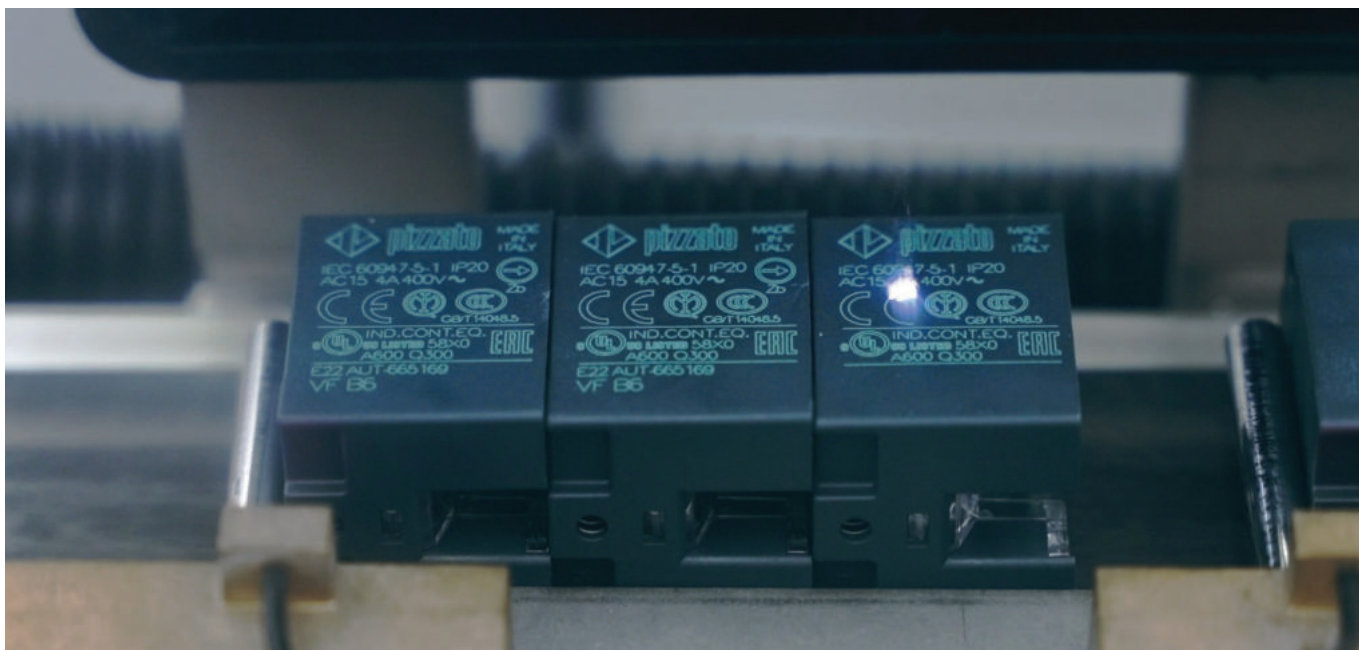

MILLIONS OF CERTIFIED PRODUCT CODES

A simple brand isn't enough: the company is aiming for the Pizzato Elettrica brand to be widely recognised as a synonym for absolute quality and certainty.

A result that has been reached and consolidated over the years, updating and expanding the series of certifications obtained from the most important Italian and international control organisations. Product quality is assessed by seven accredited external bodies: IMQ, UL, CCC, TÜV SÜD, EAC, BSI, BV. These bodies lay out high technical and qualitative standards for the company to achieve and maintain, verified yearly with several inspections: these are performed, without prior notice, by qualified inspectors, who extract samples of products and materials destined for sale from plants, or from the market directly, to subject them to apposite tests.

- **CE MARK.** All Pizzato Elettrica products bear the CE marking in conformity with the European Directives in force.
- **UKCA MARK.** All Pizzato Elettrica products bear the UKCA marking in conformity with the United Kingdom directives in force.
- **ISO 9001 CERTIFICATION.** The company's production system is compliant with the international ISO 9001 standard, in its most recent 2015 revision. The certification covers all of the company's plants and their production and managerial activities: entry checks,

technical, purchasing and commercial department activities, manufacturing operations assessments, final pre-shipping product tests and checks, equipment reviews and the management of the metrological lab.

The Pizzato Elettrica quality management system ensures that all sensitive company processes – from component design to implementation, from materials provisioning to verification of non-compliant products – are carried out according to the procedures laid down, with the aim of providing our customers with continuously improved and reliable products.

- **CERTIFICATION OF COMPANY QUALITY SYSTEMS.** Pizzato Elettrica has obtained the certificate of compliance with the UNI EN ISO 9000 regulations in force in Italy and abroad. It is issued by a recognised independent body that guarantees the quality and reliability of the service offered to clients worldwide.
- **CSQ, CISQ AND IQNET.** The CSQ system is part of the CISQ (Italian Certification of Quality Systems) federation, which consists of the primary certification bodies operating in Italy in the various product sectors. CISQ is the Italian representative body within IQNet, the biggest international Quality Systems and Company Management certification network, which is adhered to by 25 certification organs in as many countries.





GLOBAL SUBSIDIARIES

Pizzato Deutschland GmbH
Munich
Founding year: 2013
info@pizzato.com

Pizzato France Sarl
Villeurbanne - Lyon
Founding year: 2016
info@pizzato.com

Pizzato Iberica SL
Barcelona
Founding year: 2017
info@pizzato.com

Pizzato USA
East Syracuse, NY
Founding year: 2018
info@pizzatousa.com

Pizzato Elettrica India Ltd.
Pune
Founding year: 2021
info@pizzato.com

Pizzato Korea Ltd.
Seoul
Founding year: 2021
info@pizzato.com

The purpose of these subsidiaries is to coordinate and support the activities of representative agencies, or distributors, present in the various countries, managing marketing and sales activities, with further objectives of increasing brand visibility and penetration capacity of Pizzato Elettrica products in markets considered strategic.

Products from Pizzato Elettrica are currently used in over 80 countries: The commercial support network, which is made up of local professional and experienced representatives, combined with the productive capacity of the headquarters in Italy, are the basis for the formation of a group that, together with its partners, has all the necessary requirements to become one of the most important companies in the field of automation and industrial safety.

TECHNICAL AND SALES ASSISTANCE



TECHNICAL DEPARTMENT

The Pizzato Elettrica technical department provides direct technical and qualified assistance in Italian and English, helping in this way the customers to choose the suitable product for their own application explaining the characteristics and the correct installation.

Office hours: Monday to Friday
08:00 am - 12:30 pm / 02:00 pm - 05:30 pm CET
Telephone: +39.0424.470.930
E-mail: tech@pizzato.com

Spoken languages:  

SALES DEPARTMENT

Among the strengths in the company relationship with the commercial network, the direct assistance guaranteed in five languages: Italian, English, French, German and Spanish. A service that confirms Pizzato Elettrica quality and attention to the needs of customers from around the world.

Office hours: Monday to Friday
08:00 am - 12:30 pm / 02:00 pm - 05:30 pm CET
Telephone: +39.0424.470.930
E-mail: info@pizzato.com

Spoken languages:     





TRADE FAIRS AND EVENTS

TRADE FAIRS

Pizzato Elettrica regularly participate to many trade fairs in Italy and abroad, presenting in this way to the market the products, the latest news, etc.

EVENTS

Besides offering qualified technical assistance, Pizzato Elettrica presents itself as a dynamic partner who is attentive to the needs of its customers. For this reason, the company organises several meetings and training courses with particular attention to the regulatory aspect of machinery safety.



WEBSITE WWW.PIZZATO.IT

PRODUCT NEWS

Visit the website at www.pizzato.com to stay updated on all the news regarding product launches, to view the entire range of products created by Pizzato Elettrica, and to consult all the documentation provided.

SEARCH USING FILTERS

You can find the product you want by entering the relative item code, or use the filters provided to create the item most adapted to your particular requirements, by choosing the features it needs to offer.

BROWSABLE, DOWNLOADABLE CATALOGUE

Users can download the complete catalogue or alternatively browse it directly online, an extremely handy solution for those wishing to consult the range of products simply and rapidly.

HIGH RESOLUTION IMAGES

The information provided for each product is complete with high resolution images to offer visitors to the website a clear, accurate view of the items in close detail, also offering them the possibility to zoom in and out on the image.

USAGE INSTRUCTIONS

You can download product usage or installation instructions, in PDF format, to your computer.

2D AND 3D FILES

2D and 3D drawings are available for every item; in formats that are compatible with the widest variety of drawing programs.

CERTIFICATES AND EC DECLARATIONS OF CONFORMITY

The latest product type approval certificates, and EC declarations of conformity in accordance with applicable European product directives, are published on the website.

LARGE VIDEO SECTION

The large video section of the website is capable of showcasing the main characteristics, functions and use of the various products.

MULTILINGUAL TRANSLATIONS

The website's multilingual versions allow the clients of the global market to find all the information they need in one place.

WEBINARS

The webinars from Pizzato Elettrica go into detail in the area of machine safety with focus on the further development of standards. The speakers are experts with targeted specialisation and detailed knowledge of standards and directives in the industry.

CROSS-REFERENCE

It is possible to find a Pizzato Elettrica product as an alternative to others on the market in terms of functionality.



RJ45 sockets, category 6

- The new RJ45 sockets designed in accordance with cat. 6 permit speeds of up to 10 Gb/s.
- Degree of protection IP67 through integrated protection cap.
- Available in two connection versions: socket-socket with integrated RJ45 socket on the front and rear side or socket-cable with integrated RJ45 socket on the front side and cable with connector on the rear side.
- Available in version with shielding to protect against electromagnetic interference.

► 113



ES series housings with modular cover 72x80 mm EROUND Line

- The new covers offer the option of using two devices within the compact 72 x 80 mm housing.
- New cover configurations available, including a version with integrated protection guard that protects the emergency stop button from shocks.
- Protection degrees IP67 and IP69K.

► 127



BN series control device units

- The BN series of control device units has been further expanded with the new versions with 1 and 2 devices: 1 to 8 devices now fit into the modular technopolymer housings.
- New laser-markable lenses are available: the desired markings are permanently applied directly to the lenses by means of lasers.
- Wide range of available control devices.
- Rotatable modules for the greatest installation flexibility.
- Configurable with various types of connection output.
- Min. dimensions 40x40 mm.

► 143

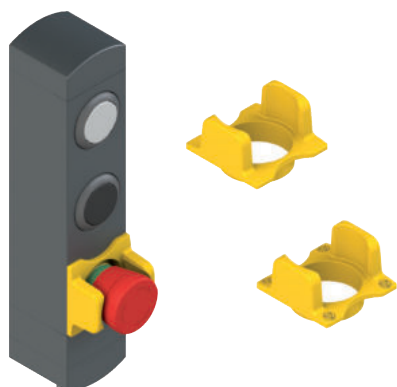

Protective cover for emergency stop buttons for the BN series

- Protective cover that absorbs undesired shocks on the emergency stop button.
- Suitable for all BN versions with emergency stop button.
- Laser-markable in compliance with EN ISO 13850.

► 146

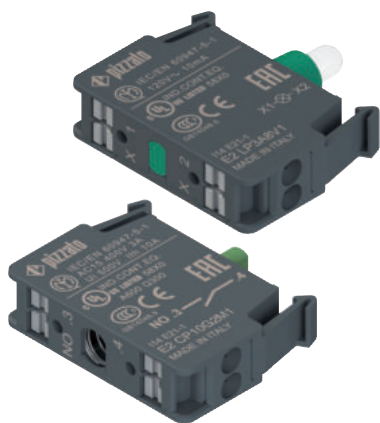

PUSH-IN spring-operated connection EROUND line

- Fast, simple conductor insertion, no tooling required.
- Quick release, with the grey button provided to release the wire.
- For 0.25 mm² to 1.5 mm² conductors, with or without wire-end sleeve.
- 1NO and 1NC contact blocks, with base or panel mounting.
- 12-30 Vac, 120 Vac, 230 Vac LED units, with base or panel mounting.

► 90



Connectors M8, M12 with new fixing ring, M23

- Large selection of connectors for cables and switch panels: optimal solution for use in combination with Pizzato switches.
- M12 connectors with new fixing ring with grooved circular and hexagonal attachment for tightening with torque-controlled tools. Available in male and female versions.
- Gold-plated contacts for increased reliability.
- Anti-vibration self-locking ring nuts.
- Highly flexible cables, suitable for use in drag chains, with oil-resistant PVC or PUR sheath acc. to IEC 60332-1-2.

► 175

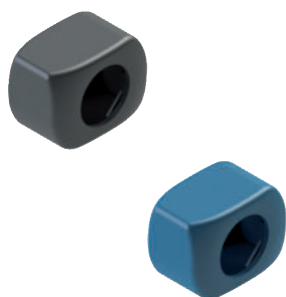

New tamper-proof protections for M12 connectors, VF PC series

- New version ensuring additional protection against tampering with the electrical connections.
- Quick assembly with two interlocking shells.
- Removal possible only by breaking the shells.
- Different versions available for connector - device and male connector - female connector connections.
- Versions available in detectable blue plastic, suitable for the food industry.

► 189

UK CA

UKCA declaration of conformity

- Following the withdrawal of the United Kingdom from the European Union, the UKCA mark (UK Conformity Assessment) for products that are placed on the market in Great Britain must be used instead of the European CE marking. For products that previously required a CE marking, the new UKCA mark for Great Britain (England, Scotland and Wales), in effect since 1 January 2021, is required.
- At the time of printing this catalogue, the British government specified 1 January 2025 as the date from which the UKCA mark will be mandatory for products that are placed on the market in Great Britain; the UKCA mark can also be used prior to this date.
- Pizzato Elettrica has already started to update the mark and will mark its own products with the newly required mark within the time frame specified in the last legislative changes.

Description



The PX and PA foot switches are traditional products of Pizzato Elettrica that have recorded a continuous growth and success in the market. Modified and updated over time, this cutting-edge series keeps offering new solutions to all flexibility and modularity demands. Moreover, the latest changes have reduced its weight and therefore its environmental impact.

Protection degree IP65

IP65 These devices are designed to be used in the toughest environmental conditions and they pass the tests required for IP65 acc. to EN 60529. They can therefore be used in all environments in which the wrapping must present a high degree of protection. Available also with IP53 for applications requiring a high price/quality ratio.

Conduit entry with cable clamp



Inside the housing immediately after the cable inlet there is a cable clamp in line with the hole. Ideal for maintaining the electrical cable in position; it prevents any tractions or repeated movements from discharging on the electrical connections of the contact blocks. Reversible, it can tighten both large and small cables.

Sturdy cap

800 N



Foot switches of the PX series are provided with a reinforced shaped cap. This solution enables the cap to bear static loads of up to 800 N without breaking, therefore being tread-proof. For particularly difficult environments, the cap can be provided in material reinforced with charges in fibre glass to also resist impacts from dynamic knocks. Furthermore, for PA series foot switches in heavy duty environments it is

also available a metal protection with oversize dimensions, designed for persons wearing safety shoes.

Side openings

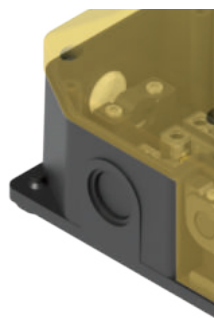

All PX and PA series foot switches are provided with two knock-out side openings. These openings enable the single pedal, via a specific joining KIT, to be laterally connected to other single Pizzato Elettrica pedals. Two normal pedals can therefore be transformed at any time into a single, sturdy double pedal. The joining kits are provided with special gaskets which maintain the device protection degree unaltered, and with a special internal conduit that allows to pass the wires from one foot switch to the next.

Stainless steel external metallic parts

AISI 304

All external metal parts of the single foot switch are made in stainless steel of the AISI 300 series. All the screws, springs and external metal sliding pivots are made of stainless steel. Ideal for applications used in presence of corrosive elements such as in the food and pharmaceutical sectors.

Contact blocks



Up to two contact blocks with two contacts each can be fitted in one foot switch. These units are available in several models, with slow or snap action and various operation travels. All contact blocks are provided with highly reliable twin bridge electrical contacts and positive opening NC contacts in accordance with IEC 60947-5-1, and are therefore suitable for safety circuits.

Non-slip rubber feet



All foot switches are provided with four dedicated non-slip feet. Being hollow in the middle, these feet guarantee smaller contact surface and greater friction coefficient. This way the actuation of the foot switch is simple and practical, preventing its sliding away on very smooth and polished floors.

Gold-plated contacts

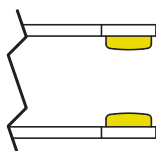

The contact blocks of these devices can be supplied gold-plated upon request. Ideal for applications with low voltages or currents; it ensures increased contact reliability. Available in two thicknesses (1 or 2.5 microns), it adapts perfectly to the various fields of application, ensuring a long endurance over time.

Safety lever

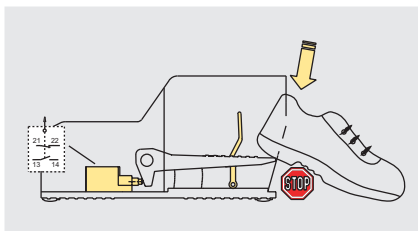
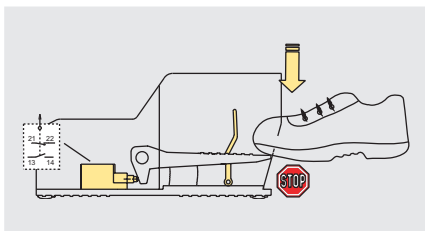

The safety lever prevents the lowering of the pedal actuator in case the foot is not fully inserted into the pedal. This prevents the accidental activation of the pedal.

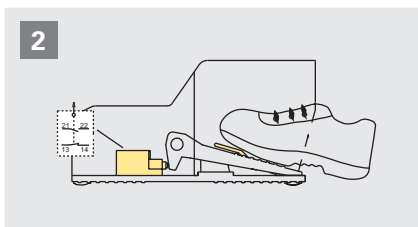
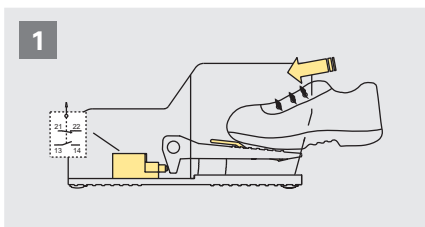

Only if the foot is completely inserted it is possible to lower the safety lever and push down the pedal actuator.

Lock of the pedal actuator

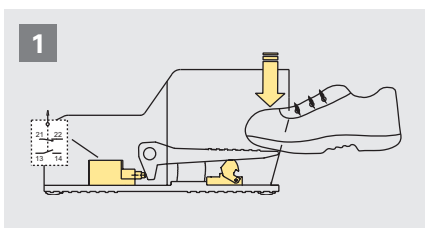

Insertion of the foot into the pedal.

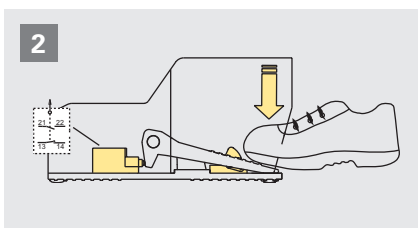

Pushing down the pedal actuator, the contacts switch and the locking device locks the actuator.

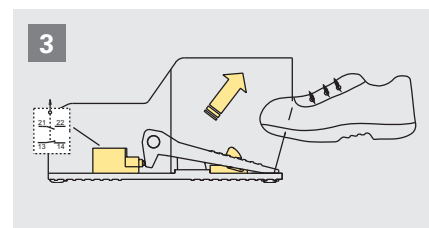

Releasing the pedal actuator, the lock device keeps it down.

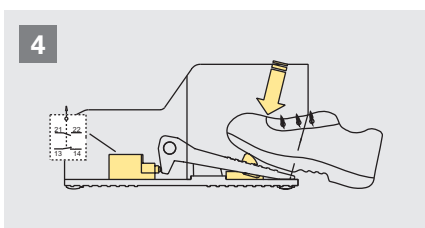

To unlock the pedal actuator push on the locking device.

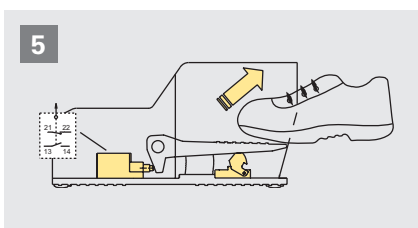

Removing the foot from the foot switch, the pedal actuator and the contacts return to their initial positions.

2-stage actuating force

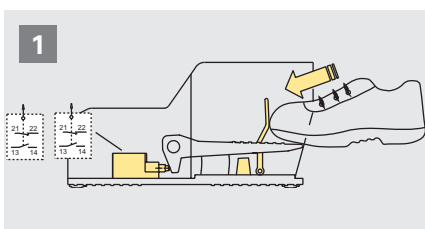

PX pedal with two shifted, snap action contact blocks (2x 1NO+1NC), 2-step actuation force and safety lever.

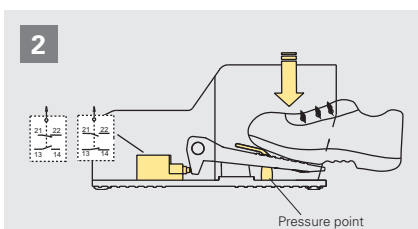

With a light pressure (~19 N) on the pedal actuator, one of the two contact blocks switches while the second keeps its state. The pedal actuator stops at pressure point.

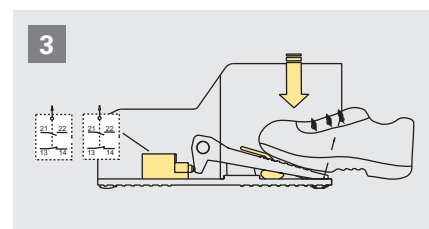

By pushing down with higher force (~180 N) on the pedal actuator, the second contact block switches as well. In this position, both contact blocks are switched.

Selection diagram

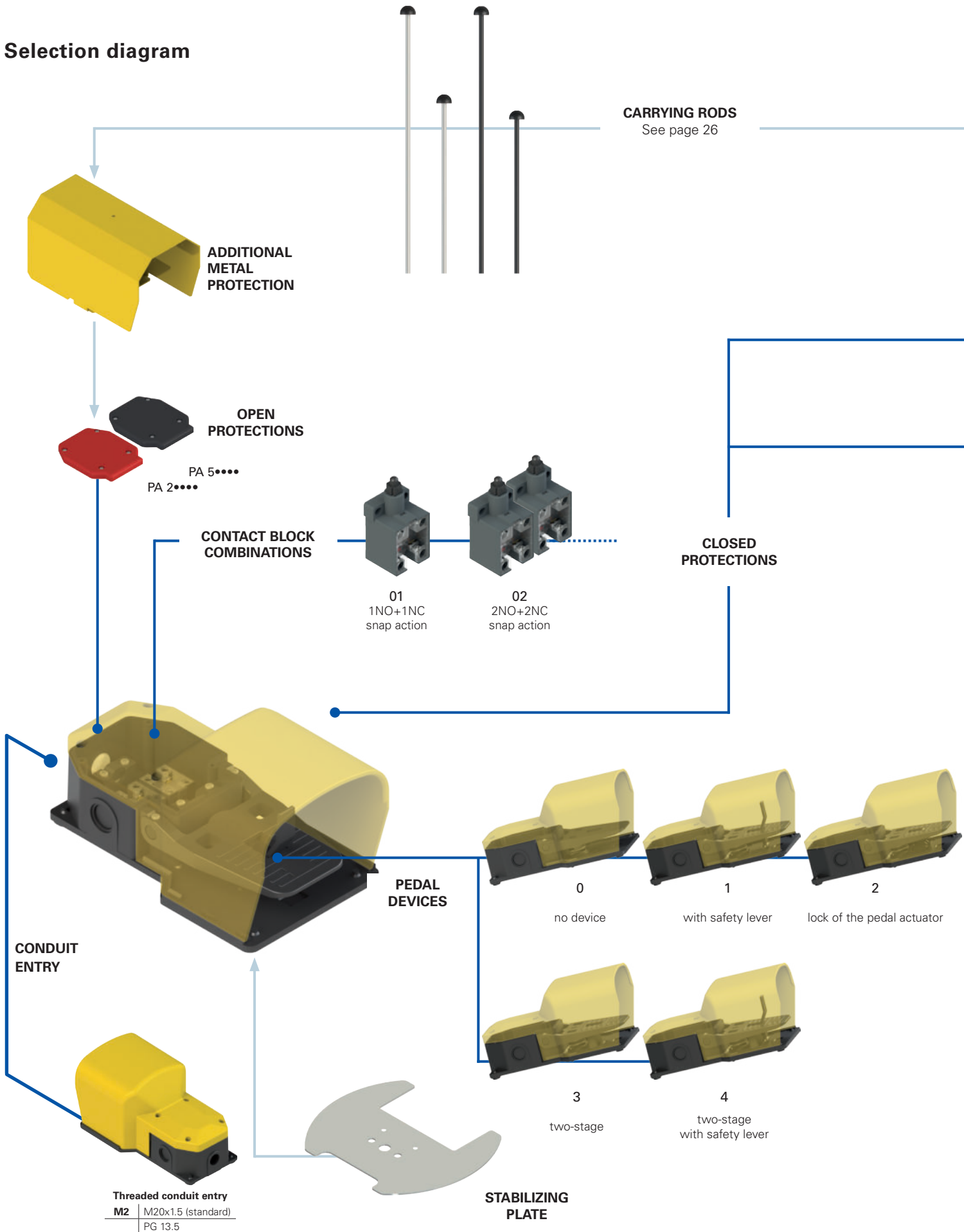

- Product options
- ➔ Sold separately as accessory

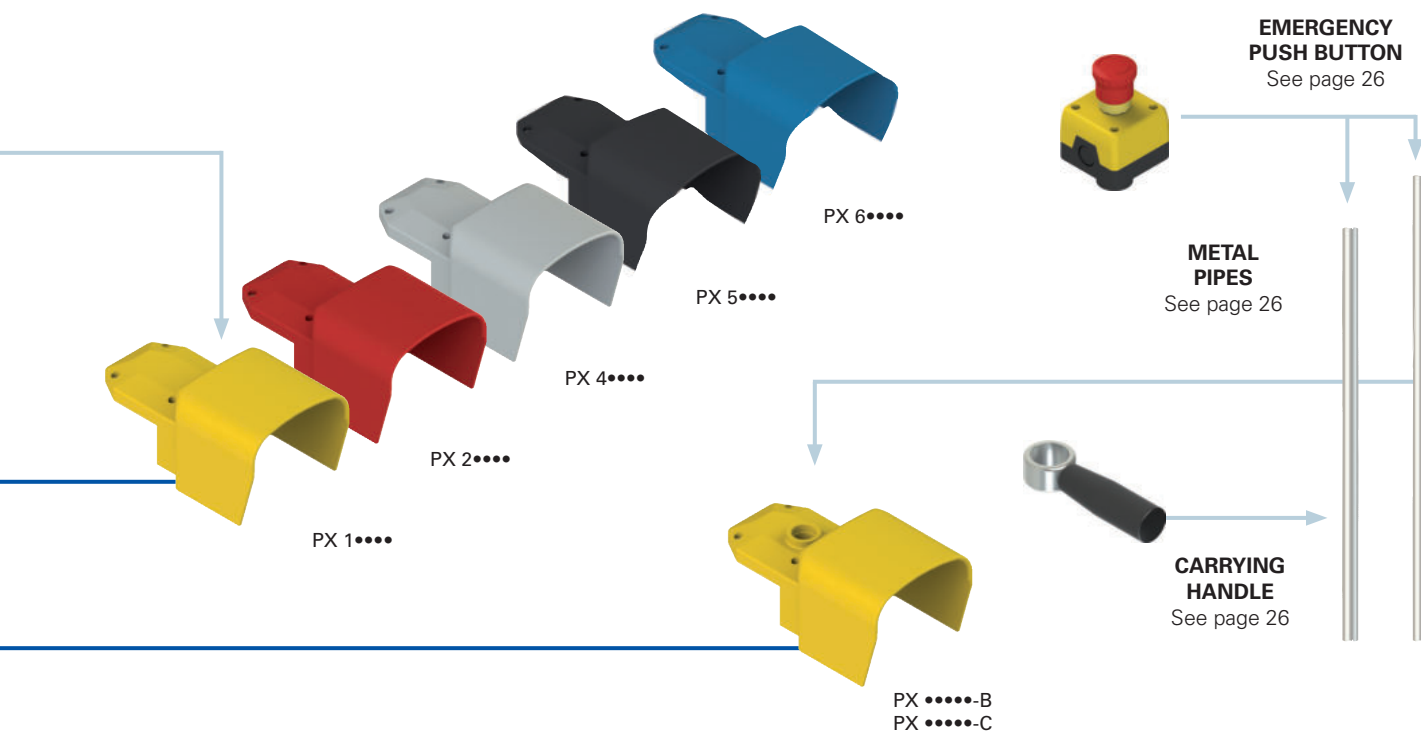
Code structure
Attention! The feasibility of a code number does not mean the effective availability of a product. Please contact our sales office.

article
options
PX 10110-AGM2

Foot switches

| | |
|-----------|----------------|
| PX | closed version |
| PA | open version |

Protection colour

| | |
|----------|----------------------------|
| 1 | yellow RAL 1023 (standard) |
| 2 | red RAL 3020 |
| 4 | grey RAL 7035 |
| 5 | black RAL 9017 |
| 6 | blue RAL 5017 |

Contact block combinations

| | |
|-----------|--|
| 01 | 1NO+1NC, snap action (VF B501) |
| 02 | 2x (1NO+1NC), snap action (VF B501+VF B501) |
| 03 | 1NO+1NC, slow action (VF B601) |
| 04 | 2x (1NO+1NC), slow action (VF B601+VF B601) |
| 05 | 2x 2NO, slow action (VF B1001+VF B1001) |
| 06 | 2x 2NC, slow action (VF B901+VF B901) |
| 07 | 2NC, slow action (VF B901) |
| 08 | 2NO, slow action (VF B1001) |
| 09 | 1NO+1NC, slow action, make before break (VF B701) |
| 14 | 2NO, snap action (VF B1201) |
| 15 | 2NC, snap action (VF B1101) |
| 20 | 2x (1NO+1NC), snap action shifted (VF B501+VF B501) |
| 24 | (1NO+1NC)+(2NC), snap action, shifted (VF B501+VF B1101) |

Other combinations on request.
For contact block data see page 29.

Threaded conduit entry

| | |
|-----------|--------------------|
| M2 | M20x1.5 (standard) |
| | PG 13.5 |

Contact type

| | |
|-----------|--|
| | silver contacts (standard) |
| G | silver contacts with 1 µm gold coating |
| G1 | silver contacts with 2.5 µm gold coating |

Accessories (PX series only)

| | |
|----------|---|
| | no accessories |
| A | with technopolymer carrying rod (400 mm) |
| B | with M25 hole for VF KIT31 |
| C | with M25 hole for VF KIT31 with stabilizing plate |
| D | with technopolymer carrying rod (660 mm) |

Protection degree

| | |
|----------|------|
| 0 | IP53 |
| 1 | IP65 |

Devices

| | |
|----------|--|
| 0 | no device |
| 1 | with safety lever |
| 2 | lock of the pedal actuator |
| 3 | without safety lever and with two-stage actuating force (only with contact block combination 20, 24) |
| 4 | with safety lever and with two-stage actuating force (only with contact block combination 20, 24) |

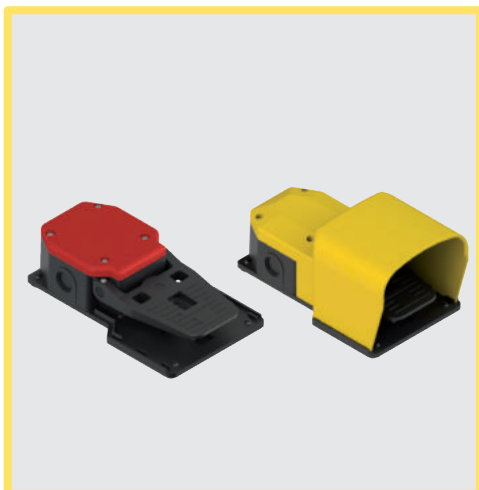

Main features

- Technopolymer, shock-proof housing
- Protection degree IP53 or IP65
- 14 contact blocks available
- Several auxiliary devices available
- Assemblable through special joining kits

Quality marks:

complete foot switch



EAC approval: RU C-IT.YT03.B.00035/19

Internal contact block



IMQ approval: CA02.06217

UL approval: E131787

CCC approval: 2021000305000102

EAC approval: RU C-IT.YT03.B.00035/19

Technical data

Housing

Housing with double insulation:



Base:

glass fibre reinforced technopolymer, self-extinguishing and shock-proof technopolymer, self-extinguishing and shock-proof

Cap:

stainless steel

External metallic parts:

Cap screw tightening torque:

0.8 ... 1.2 Nm

Actuating force:

16 N

One threaded conduit entry:

M20x1.5 (standard)

Cable clamp screw tightening torque:

0.8 ... 1 Nm

Protection degree:

IP53 (P•••••0-M2) or

IP65 (P•••••1-M2)

acc. to EN 60529 with cable gland of equal or higher protection degree

Utilization requirements:

see page 172

General data

Ambient temperature:

-25°C ... +80°C

Safety parameter B_{10D} :

20,000,000 for NC contacts

Max. operating frequency:

3600 operating cycles/hour

Mechanical endurance:

10 million operating cycles

Cable cross section (flexible copper strands)

Contact block combinations (all):

min. 1 x 0.5 mm² (1 x AWG 20)

max. 2 x 2.5 mm² (2 x AWG 14)

Terminal screw tightening torque:

0.6 ... 0.8 Nm

Cable stripping length (x):

8 mm



In compliance with standards:

IEC 60947-5-1, EN 60947-5-1, IEC 60947-1, EN 60947-1, EN 60529, EN IEC 63000, UL 508, CSA C22.2 No. 14, GB/T14048.5.

Compliance with the requirements of:

Low Voltage Directive 2014/35/EU,

EMC Directive 2014/30/EU,

RoHS Directive 2011/65/EU.

Positive contact opening in conformity with standards:

IEC 60947-5-1, EN 60947-5-1.

⚠ Installation for safety applications:

Use only switches marked with the \ominus symbol beside the product code. Always connect the safety circuit to the **NC contacts** (normally closed contacts: 11-12, 21-22 or 31-32) as required by **EN ISO 14119, paragraph 5.4** for specific interlock applications and **EN ISO 13849-2 table D3** (well-tried components) and **D.8** (fault exclusions) for safety applications in general.

Electrical data

| | |
|--|-----------------------------|
| Thermal current (I_{th}): | 10 A |
| Rated insulation voltage (U): | 500 Vac 600 Vdc |
| Rated impulse withstand voltage (U_{imp}): | 6 kV |
| Conditional short circuit current: | 1000 A acc. to EN 60947-5-1 |
| Protection against short circuits: | type aM fuse 10 A 500 V |
| Pollution degree: | 3 |

Utilization category

| | | | |
|--------------------------------------|-----|------|-----|
| Alternating current: AC15 (50-60 Hz) | | | |
| Ue (V) | 250 | 400 | 500 |
| Ie (A) | 6 | 4 | 1 |
| Direct current: DC13 | | | |
| Ue (V) | 24 | 125 | 250 |
| Ie (A) | 3 | 0.55 | 0.3 |

Dimensional drawings

Contact type:

- R** = snap action
- L** = slow action
- LO** = slow action, make before break
- RS** = snap action, shifted

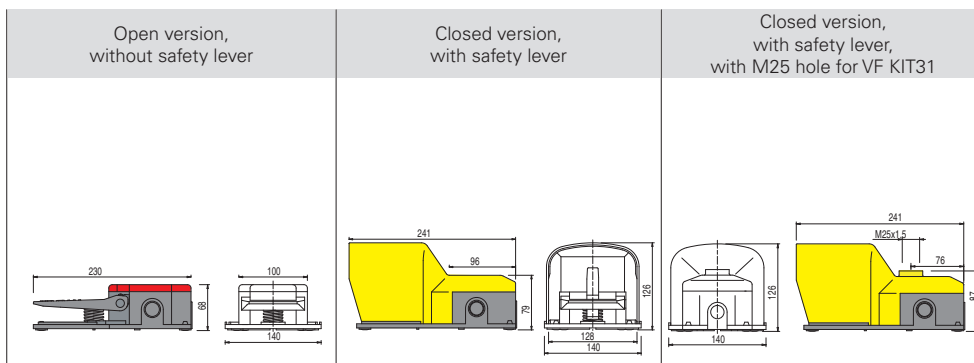

| Contact block combinations | Contact type | Actuation stages | Open version, without safety lever | | Closed version, with safety lever | | Closed version, with safety lever, with M25 hole for VF KIT31 | | Travel diagram |
|----------------------------|--------------|------------------|------------------------------------|--------------------|-----------------------------------|--------------------|---|--------------------|----------------|
| | | | Article | Contacts | Article | Contacts | Article | Contacts | |
| 01 | R | 1 | PA 20100-M2 | 1NO+1NC | PX 10110-M2 | 1NO+1NC | PX 10110-BM2 | 1NO+1NC | |
| 02 | R | 1 | PA 20200-M2 | 1NO+1NC 1NO+1NC | PX 10210-M2 | 1NO+1NC 1NO+1NC | PX 10210-BM2 | 1NO+1NC 1NO+1NC | |
| 03 | L | 1 | PA 20300-M2 | 1NO+1NC | PX 10310-M2 | 1NO+1NC | PX 10310-BM2 | 1NO+1NC | |
| 04 | L | 1 | PA 20400-M2 | 1NO+1NC 1NO+1NC | PX 10410-M2 | 1NO+1NC 1NO+1NC | PX 10410-BM2 | 1NO+1NC 1NO+1NC | |
| 05 | L | 1 | PA 20500-M2 | 2NO 2NO | PX 10510-M2 | 2NO 2NO | PX 10510-BM2 | 2NO 2NO | |
| 06 | L | 1 | PA 20600-M2 | 2NC 2NC | PX 10610-M2 | 2NC 2NC | PX 10610-BM2 | 2NC 2NC | |
| 07 | L | 1 | PA 20700-M2 | 2NC | PX 10710-M2 | 2NC | PX 10710-BM2 | 2NC | |
| 08 | L | 1 | PA 20800-M2 | 2NO | PX 10810-M2 | 2NO | PX 10810-BM2 | 2NO | |
| 09 | LO | 1 | PA 20900-M2 | 1NO+1NC | PX 10910-M2 | 1NO+1NC | PX 10910-BM2 | 1NO+1NC | |
| 14 | R | 1 | PA 21400-M2 | 2NO | PX 11410-M2 | 2NO | PX 11410-BM2 | 2NO | |
| 15 | R | 1 | PA 21500-M2 | 2NC | PX 11510-M2 | 2NC | PX 11510-BM2 | 2NC | |
| 20 | RS | 2 | PA 22030-M2 | 1NO+1NC 1NO+1NC | PX 12040-M2 | 1NO+1NC 1NO+1NC | PX 12040-BM2 | 1NO+1NC 1NO+1NC | |
| 24 | RS | 2 | PA 22430-M2 | 1NO+1NC 2NC | PX 12440-M2 | 1NO+1NC 2NC | PX 12440-BM2 | 1NO+1NC 2NC | |

For contact block data see page 29.

Key to travel diagrams

- Closed contact
- Open contact
- Positive opening travel
- Pressing the pedal
- Releasing the pedal

All values in the drawings are in mm

Accessories See page 173

 The 2D and 3D files are available at www.pizzato.com

Combination examples



All values in the drawings are in mm

Foot switch, closed version, provided with a 400 mm technopolymer carrying rod

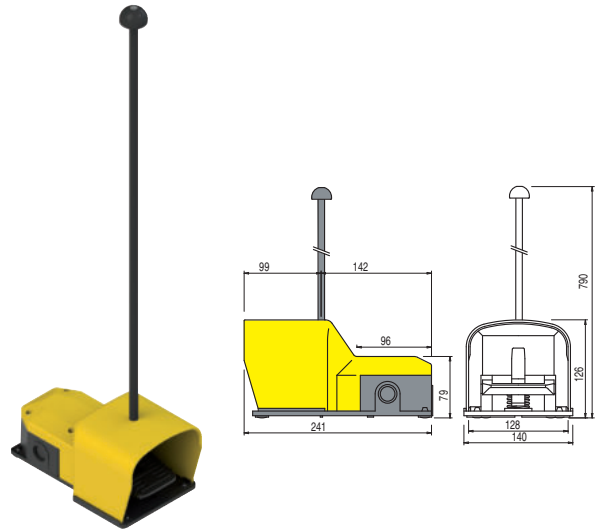
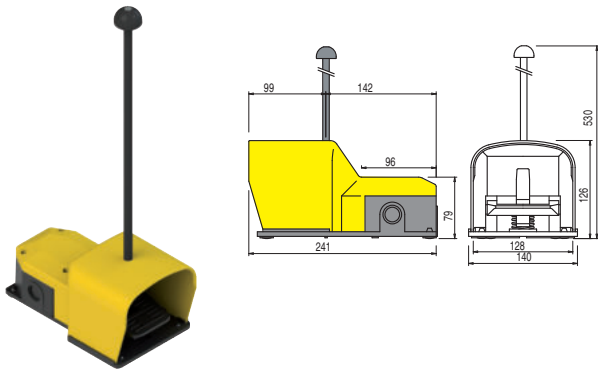
Foot switch, closed version, provided with a 660 mm technopolymer carrying rod





Ordering example:

| | | | |
|--|--|--|--|
|  |  | | |
| PX 10110-M2 | VF KIT21 | | |

This article can also be purchased with single code PX 10110-AM2. In this case the cap is supplied already perforated for the carrying rod fixing.

Ordering example:

| | | | |
|--|---|--|--|
|  |  | | |
| PX 10110-M2 | VF KIT22 | | |



This article can also be purchased with single code PX 10110-DM2. In this case the cap is supplied already perforated for the carrying rod fixing.

Foot switch, closed version, provided with M25x1.5 hole and stabilizing plate

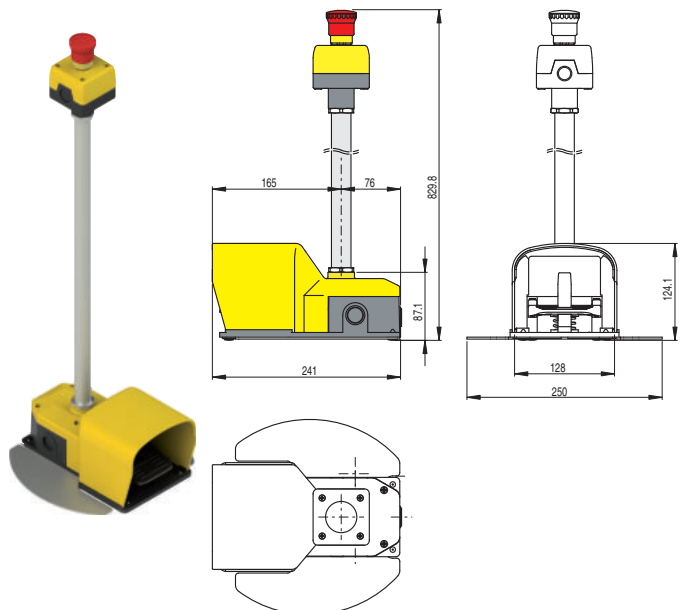
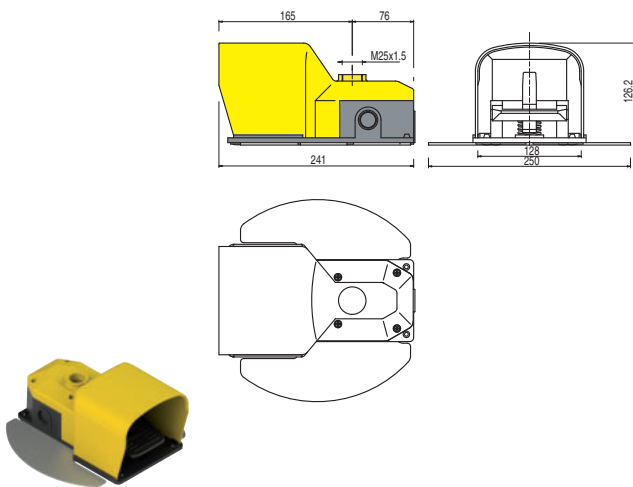
Foot switch, closed version, provided with metal pipe, stabilizing plate and emergency stop button 1NC







Ordering example:

| | | | |
|---|---|--|--|
|  |  | | |
| PX 10110-BM2 | VF KIT60 | | |

This article can also be purchased with single code PX 10110-CM2.

Ordering example:

| | | | |
|---|--|---|---|
|  |  |  |  |
| PX 10110-BM2 | VF KIT60 | VF KIT31 | VF KIT32 |

Combination examples

Foot switch, open version, provided with an additional metal protection. Ideal for heavy duty applications with safety shoes.

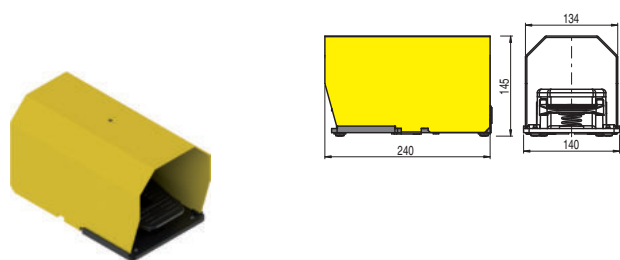

Ordering example:

| | | | |
|-------------|----------|--|--|
| | | | |
| PA 20100-M2 | VF KIT71 | | |

Foot switch, open version, provided with metal protection and a 400 mm metal carrying rod. In heavy-duty work environments, protection hood with increased dimensions for safety shoes.

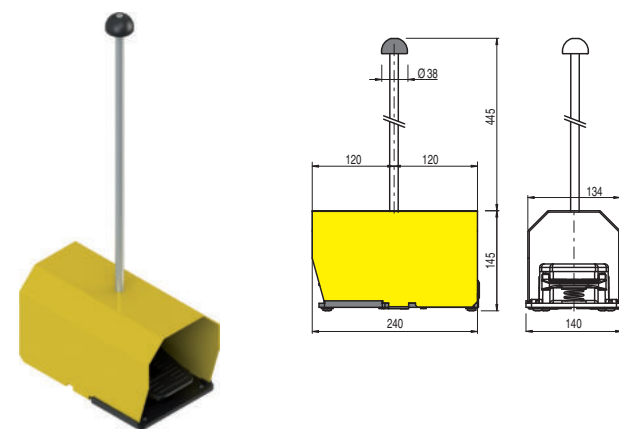

Ordering example:

| | | | |
|-------------|----------|----------|--|
| | | | |
| PA 20100-M2 | VF KIT71 | VF KIT25 | |

Foot switch, closed version, provided with metal pipe, stabilizing plate, carrying handle and emergency stop button 1NC

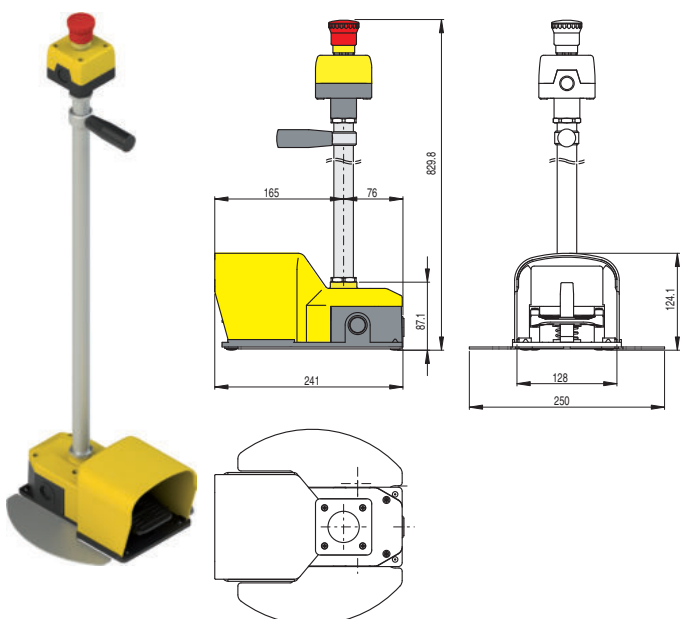

Ordering example:

| | | | | |
|--------------|----------|----------|----------|----------|
| | | | | |
| PX 10110-BM2 | VF KIT60 | VF KIT31 | VF KIT32 | VF KIT50 |

Foot switch, closed version, provided with shifted contacts, two-stage actuating force, metal pipe, stabilizing plate, carrying handle and emergency stop button 1NC

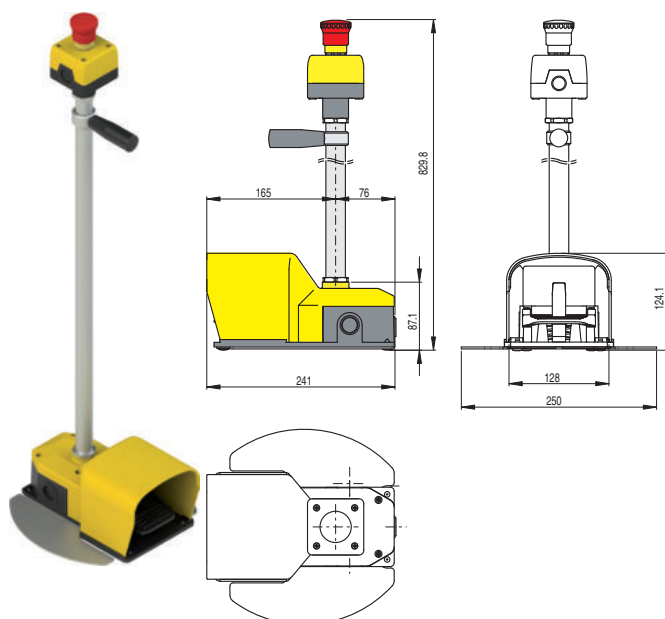

Ordering example:

| | | | | |
|--------------|----------|----------|----------|----------|
| | | | | |
| PX 12040-BM2 | VF KIT60 | VF KIT31 | VF KIT32 | VF KIT50 |

Selection diagram

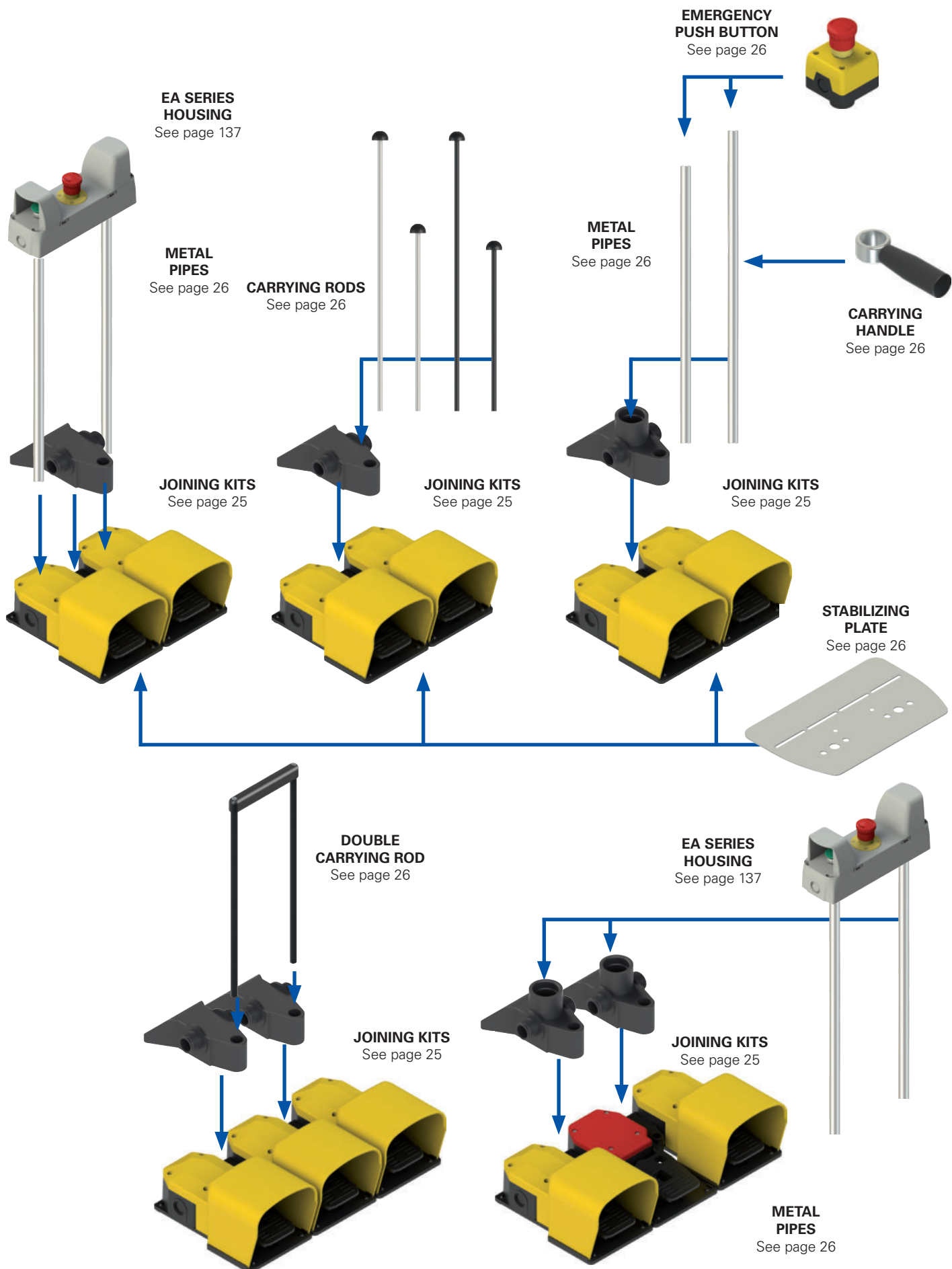

● Product options
→ Sold separately as accessory

Combinations of existing double foot switches

If you wish to purchase modular foot switches already assembled or with a single order code, please contact our sales department. Before contacting our offices, please look at the following table where some already assigned multiple foot switch combinations are listed.

| Code | Left foot switch | Joining element | Right foot switch | Additional sets |
|----------|------------------|-----------------|-------------------|---|
| PC 2-101 | PX 10110-M2 | VF KIT20 | PX 10110-M2 | VF KIT21 |
| PC 2-102 | PX 10111-M2 | VF KIT20 | PX 10111-M2 | |
| PC 2-103 | PX 20110-M2 | VF KIT20 | PX 10210-M2 | VF KIT21 |
| PC 2-104 | PX 20110-M2 | VF KIT20 | PX 10110-M2 | VF KIT21 |
| PC 2-105 | PX 10110-M2 | VF KIT20 | PX 20110-M2 | VF KIT21 |
| PC 2-106 | PX 10120-M2 | VF KIT20 | PX 10110-M2 | VF KIT21 |
| PC 2-107 | PX 10310-M2 | VF KIT20 | PX 10310-M2 | VF KIT21 |
| PC 2-108 | PX 10410-M2 | VF KIT20 | PX 10410-M2 | VF KIT21 |
| PC 2-109 | PX 10210-M2 | VF KIT20 | PX 10210-M2 | VF KIT21 |
| PC 2-110 | PX 10301-M2 | VF KIT20 | PX 10301-M2 | |
| PC 2-111 | PX 10100-M2 | VF KIT20 | PX 10100-M2 | |
| PC 2-112 | PX 10111-M2 | VF KIT20 | PX 10111-M2 | VF KIT21 |
| PC 2-113 | PX 10120-M2 | VF KIT20 | PX 10120-M2 | VF KIT21 |
| PC 2-114 | PX 10411-M2 | VF KIT20 | PX 10411-M2 | VF KIT21 |
| PC 2-115 | PX 10211-M2 | VF KIT20 | PX 10201-M2 | |
| PC 2-116 | PX 10211-M2 | VF KIT20 | PX 10211-M2 | VF KIT21 |
| PC 2-117 | PX 10100-M2 | VF KIT20 | PX 10210-M2 | VF KIT21 |
| PC 2-118 | PA 20100-M2 | VF KIT20 | PX 10110-M2 | VF KIT21 |
| PC 2-119 | PA 20101-M2 | VF KIT20 | PX 10111-M2 | VF KIT21 |
| PC 2-120 | PA 20300-M2 | VF KIT20 | PX 10310-M2 | VF KIT21 |
| PC 2-121 | PA 20120-M2 | VF KIT20 | PX 10110-M2 | VF KIT21 |
| PC 2-122 | PA 20121-M2 | VF KIT20 | PX 10111-M2 | VF KIT21 |
| PC 2-123 | PA 20200-M2 | VF KIT20 | PX 10810-M2 | VF KIT21 |
| PC 2-124 | PA 20100-M2 | VF KIT20 | PX 10210-M2 | VF KIT21 |
| PC 2-125 | PA 20100-M2 | VF KIT20 | PX 10100-M2 | VF KIT21 |
| PC 2-126 | PA 20100-M2 | VF KIT20 | PA 20100-M2 | VF KIT21 |
| PC 2-127 | PA 20400-M2 | VF KIT20 | PA 20400-M2 | VF KIT21 |
| PC 2-128 | PX 10110-M2 | VF KIT30 | PX 10110-M2 | |
| PC 2-129 | PA 20100-M2 | VF KIT30 | PX 10110-M2 | |
| PC 2-130 | PX 10111-M2 | VF KIT30 | PX 10111-M2 | |
| PC 2-131 | PX 10110-BM2 | VF KIT20 | PX 10110-BM2 | |
| PC 2-132 | PX 10111-M2 | VF KIT30 | PX 10111-M2 | VF KIT29 + VF KIT32 + VF KIT50 |
| PC 2-133 | PX 20210-M2 | VF KIT20 | PX 20210-M2 | |
| PC 2-134 | PX 20410-M2 | VF KIT20 | PX 20410-M2 | |
| PC 2-35 | PX 20211-M2 | VF KIT20 | PX 20211-M2 | |
| PC 2-137 | PX 10421-M2 | VF KIT20 | PX 10401-M2 | |
| PC 2-138 | PX 10210-M2 | VF KIT20 | PX 20210-M2 | VF KIT21 |
| PC 2-139 | PX 40220-M2 | VF KIT20 | PX 40200-M2 | |
| PC 2-40 | PA 20100-M2 | VF KIT20 | PX 10110-M2 | VF KIT22 |
| PC 2-141 | PX 10110-M2 | VF KIT20 | PA 20100-M2 | |
| PC 2-142 | PX 10111-M2 | VF KIT30 | PX 10111-M2 | VF KIT31 + VF KIT32 |
| PC 2-143 | PX 10100-M2 | VF KIT30 | PX 10210-M2 | VF KIT31 + VF KIT33 |
| PC 2-144 | PX 10810-M2 | VF KIT30 | PX 10110-M2 | VF KIT31 + VF KIT32 |
| PC 2-145 | PX 40100-M2 | VF KIT30 | PX 40100-M2 | VF KIT31 + VF KIT33 |
| PC 2-146 | PA 20100-M2 | VF KIT30 | PX 10110-M2 | VF KIT31 + VF KIT36 |
| PC 2-147 | PX 10110-M2 | VF KIT30 | PX 12040-M2 | VF KIT31 + VF KIT34 |
| PC 2-148 | PX 10110-M2 | VF KIT20 | PX 10110-M2 | VF KIT21 + VF KIT61 |
| PC 2-149 | PX 10111-M2 | VF KIT30 | PX 10111-M2 | VF KIT29 + VF KIT32 + VF KIT50 + VF KIT61 |
| PC 2-150 | PX 40310-M2 | VF KIT30 | PA 20300-M2 | VF KIT29 + VF KIT32 |

Combinations of existing triple foot switches

| Code | Left foot switch | Joining element | Central foot switch | Joining element | Right foot switch | Additional sets |
|---------|------------------|-----------------|---------------------|-----------------|-------------------|------------------------------|
| PC 3-11 | PX 10110-M2 | VF KIT20 | PA 20100-M2 | VF KIT20 | PX 10110-M2 | |
| PC 3-12 | PX 10100-M2 | VF KIT20 | PX 10100-M2 | VF KIT20 | PX 10100-M2 | |
| PC 3-13 | PX 10110-M2 | VF KIT20 | PA 20100-M2 | VF KIT20 | PX 10110-M2 | VF KIT40 |
| PC 3-14 | PX 10110-M2 | VF KIT30 | PX 10110-M2 | VF KIT30 | PX 10110-M2 | 2x VF KIT31 + 2x VF KIT18 |

Note:

VF KIT21, 22, 26, 29, 31, 32, 33, 34, 35, 40, 50 sets are not supplied assembled because, in order to be wired, kits should be first disassembled in any case.

How to combine the modular foot switches

All single foot switches (see page 17) are provided with knock-out side openings, designed for inserting the threaded ends of the joining elements. By tightening the threaded nuts of the joining elements a tight cable feed-through for electrical cables is created between the foot switches. In addition to this, with the supplied screws, the joining elements allow the definitive mechanical locking and the stabilization of two or more foot switches as a single object.

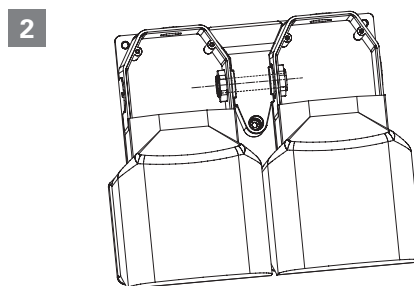
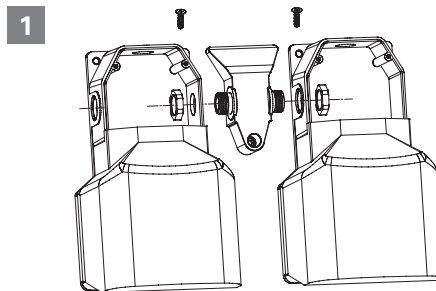
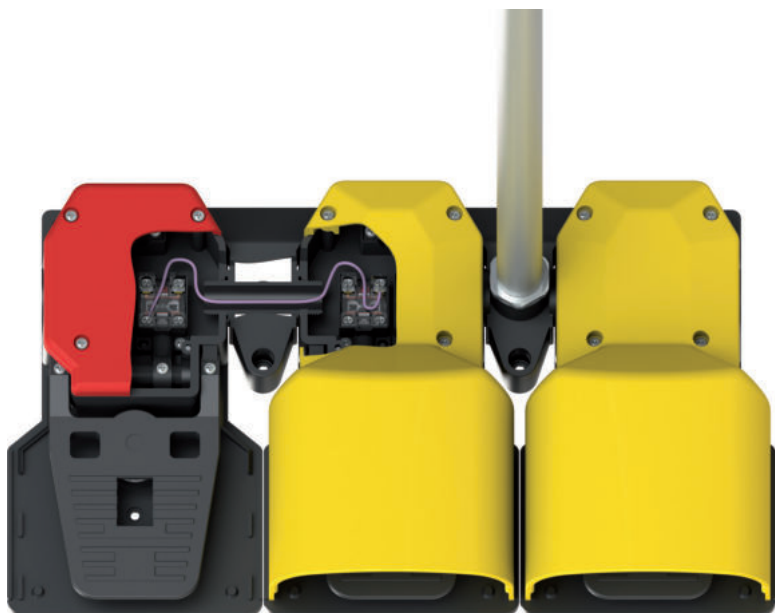

Besides the possibility of joining from two to four single foot switches, the joining elements make it possible to apply a metal tube that enables the electrical connection between the foot contacts and the contacts of an emergency push button, connected to the same tube, preserving thus an IP65 protection degree.

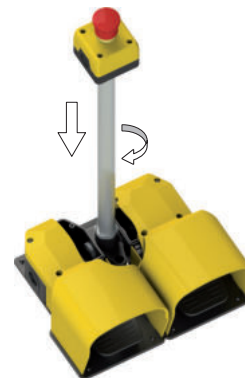
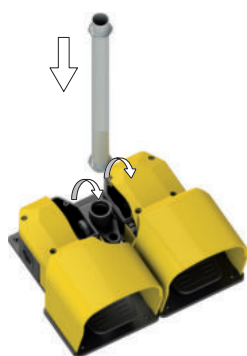

Joining elements for modular foot switches

| Article | Description |
|----------|-----------------|
| VF KIT20 | Joining element |

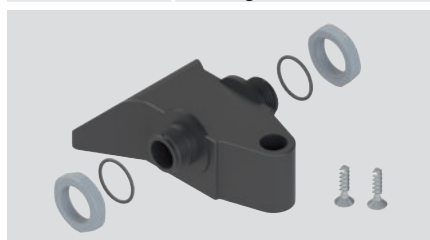

Joining element for technopolymer pedals with hole for carrying rod, with nuts, seals and self-tapping screws for the fixing of the two single pedals. Protection degree IP65.

| Article | Description |
|----------|-----------------|
| VF KIT30 | Joining element |



Joining kit for technopolymer pedals with M25x1.5 threaded hole (for VF KIT31 or VF KIT29) with nuts, gaskets and self-tapping screws for joining two single pedals. Protection degree IP65.

Auxiliary elements for modular foot switches

| Article | Description |
|----------|----------------------------|
| VF KIT21 | Carrying rod set, L=400 mm |
| VF KIT22 | Carrying rod set, L=660 mm |

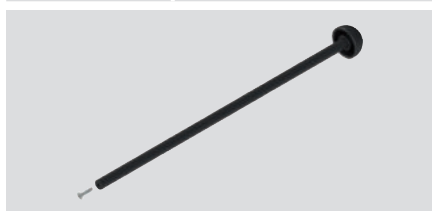

Plastic carrying rod set (can be connected to VF KIT20) with self-tapping screw for rod fixing.

| Article | Description |
|----------|-----------------------------------|
| VF KIT40 | Double carrying rod set, L=400 mm |
| VF KIT41 | Double carrying rod set, L=600 mm |

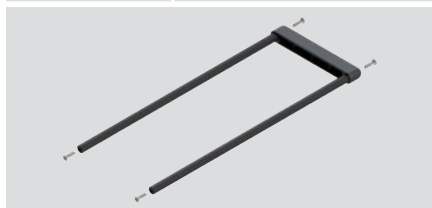

Double carrying rod kit with handle and self-tapping screws for fixing, to be combined with two VF KIT20.

| Article | Description |
|----------|-------------|
| VF KIT18 | Metal nut |



Metal nut M25x1.5 to combine with VF KIT31 or VF KIT29 if housings of the EA series are used.
Packs of 10 pcs.

| Article | Description |
|----------|-----------------|
| VF KIT50 | Carrying handle |

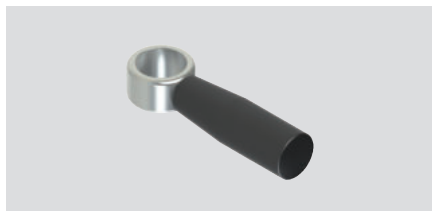

Carrying handle kit for metal tube Ø 25 mm (VF KIT31 - VF KIT29).

| Article | Description |
|----------|-------------------------|
| VF KIT61 | Metal stabilizing plate |

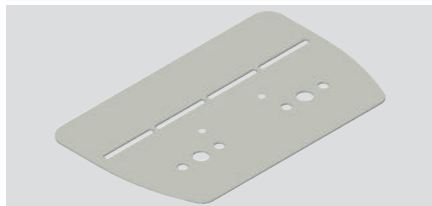

Metal stabilizing plate for double pedals.

Note:VF KIT21, 22, 25, 26, 29, 31, 32, 33, 34, 35, 40, 41, 50 sets can be supplied already assembled.

| Article | Description |
|---------|---|
| AC 1270 | Closed protection, yellow technopolymer |
| AC 1027 | Closed protection, red technopolymer |
| AC 1271 | Closed protection, grey technopolymer |
| AC 1275 | Closed protection, black technopolymer |
| AC 1276 | Closed protection, blue technopolymer |

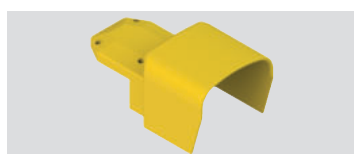

Ideal as a spare part, in case of damage to the one provided with the foot switch.

| Article | Description |
|----------|----------------------------------|
| VF KIT25 | Metal carrying rod set, L=400 mm |
| VF KIT26 | Metal carrying rod set, L=660 mm |



Metal carrying rod set (can be connected to VF KIT20) with self-tapping screw for rod fixing.

| Article | Description |
|----------|----------------------------------|
| VF KIT31 | Ø 25 mm metal tube set, L=660 mm |
| VF KIT29 | Ø 25 mm metal tube set, L=740 mm |

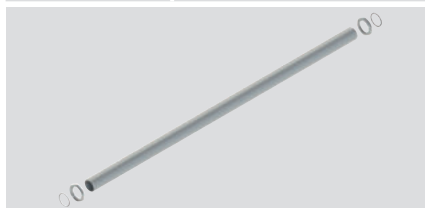

Ø 25 mm metal tube set with M25x1.5 threaded ends (for VF KIT32, VF KIT33, VF KIT34, VF KIT35) with metal nuts and gaskets.
Protection degree IP65.

| Article | Description |
|----------|------------------------------------|
| VF KIT32 | Emergency stop button kit, 1NC |
| VF KIT33 | Emergency stop button kit, 1NC+1NO |
| VF KIT34 | Emergency stop button kit, 2NC |
| VF KIT35 | Housing set for Ø 22 mm buttons |

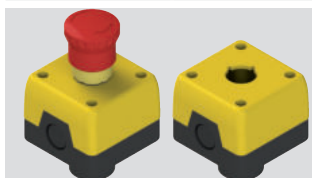

Emergency stop button kit, rotary release, compliant with EN 60947-5-1 and EN ISO 13850, to combine with VF KIT31 or VF KIT29.
Protection degree IP65.

Additional contacts on page 87.

| Article | Description |
|----------|-------------------------|
| VF KIT60 | Metal stabilizing plate |

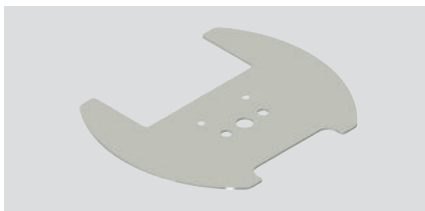

Metal stabilizing plate for single pedal.

| Article | Description |
|----------|--------------------------------|
| VF KIT71 | Yellow single metal protection |

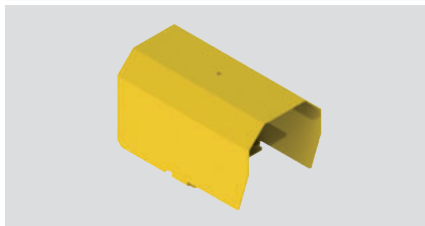

Additional metal protections for single PA series foot switches. In heavy-duty work environments, increased dimensions for safety shoes. Not applicable with VF KIT60.

| Article | Description |
|----------|--------------------------------|
| VF KIT81 | Yellow double metal protection |

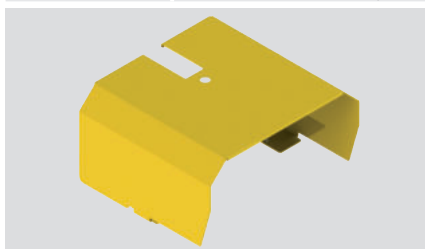

Additional metal protections for PC series modular foot switches. In heavy-duty work environments, increased dimensions for safety shoes. Not applicable with VF KIT61.

Combination examples

Double foot switches with joining device, metal tube and 1NC emergency stop button

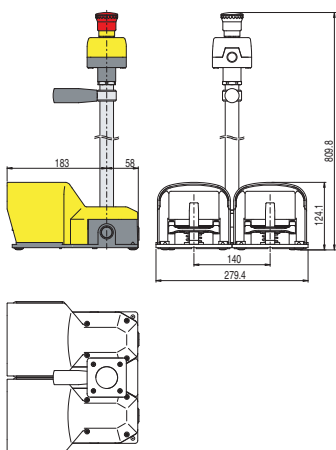

Ordering example:

| | |
|----------------|----------|
| | |
| 2x PX 10110-M2 | VF KIT30 |
| | |
| VF KIT50 | VF KIT31 |
| | |
| VF KIT32 | |

Triple foot switches with two joining devices and double carrying rod

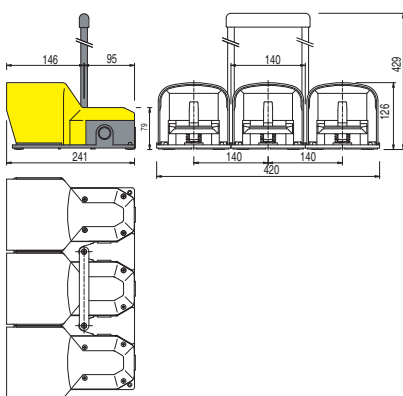

Ordering example:

| | |
|----------------|-------------|
| | |
| 3x PX 10110-M2 | 2x VF KIT20 |
| | |
| VF KIT40 | |

Double foot switch with joining device, two metal tubes, stabilizing plate and EA series housing



EA SERIES HOUSING
See page 137

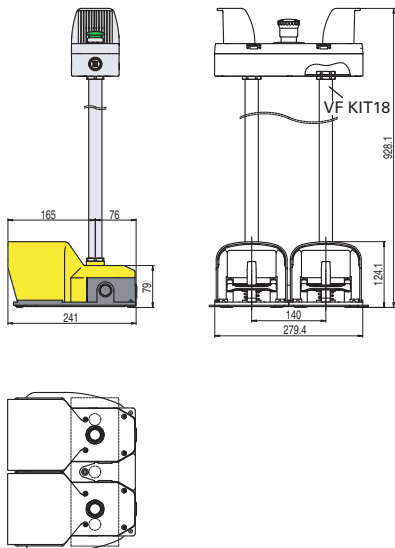

Ordering example:

| | |
|-----------------|-------------|
| | |
| 2x PX 10110-BM2 | VF KIT20 |
| | |
| 2x VF KIT29 | 2x VF KIT18 |
| | |
| VF KIT61 | EA AC37041 |

Triple foot switches with two joining devices, two metal tubes and EA series housing

EA SERIES HOUSING
See page 137

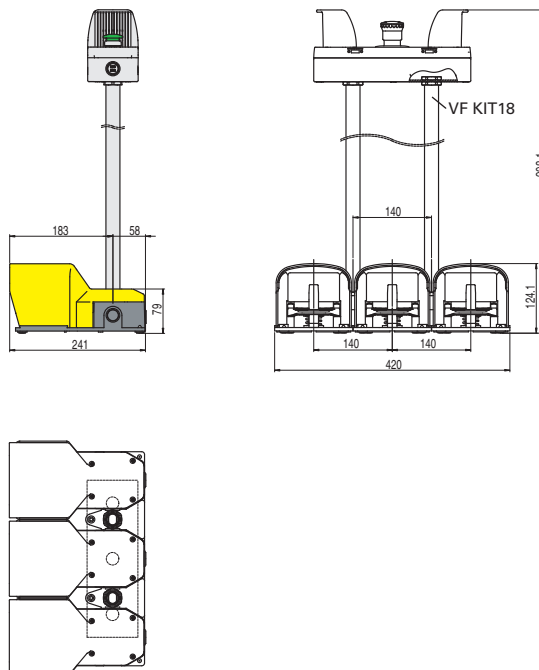

Ordering example:

| | |
|----------------|-------------|
| | |
| 3x PX 10110-M2 | 2x VF KIT30 |
| | |
| 2x VF KIT29 | 2x VF KIT18 |
| | |
| EA AC37041 | |

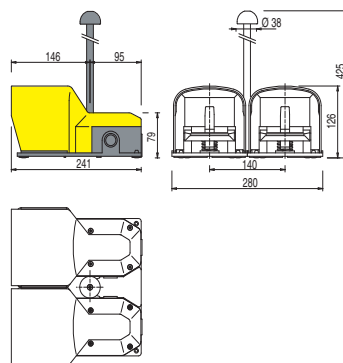
Double foot switches with joining device and carrying rod

Ordering example:

| | |
|----------------|----------|
| | |
| 2x PX 10110-M2 | VF KIT20 |
| | |
| VF KIT21 | |

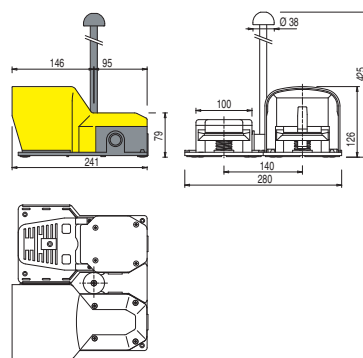
Double foot switches (available with or without pedal actuator protection) with joining device and carrying rod

Ordering example:

| | |
|-------------|-------------|
| | |
| PX 10110-M2 | PA 20100-M2 |
| | |
| VF KIT20 | VF KIT21 |

All values in the drawings are in mm

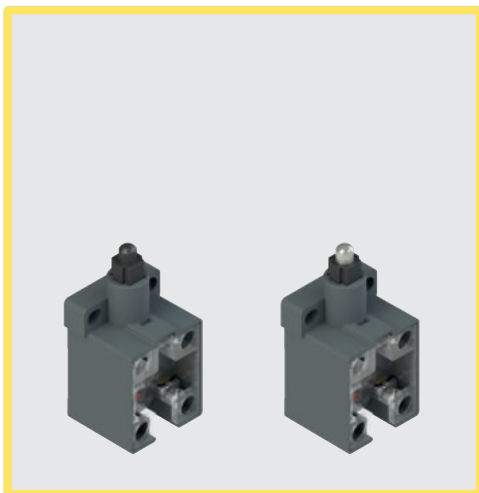

Main features

- Technopolymer housing
- Protection degree IP20 (terminals), IP40 (contacts)
- 14 contact blocks available
- Actuators with plastic or metal plunger
- Contact block with positive opening ⊕
- For internal use in PA, PX, PC series foot switches

Quality marks:



| | |
|---------------|-------------------------|
| IMQ approval: | CA02.06217 |
| UL approval: | E131787 |
| CCC approval: | 2021000305000102 |
| EAC approval: | RU C-IT.YT03.B.00035/19 |

Technical data

Housing

Housing made of glass fibre reinforced technopolymer, self-extinguishing and shock-proof
 Protection degree acc. to EN 60529: IP20 (terminals)
 IP40 (contacts)

General data

Ambient temperature: -40°C ... +80°C
 Safety parameter B_{10D}: 40,000,000 for NC contacts
 Max. actuation frequency: 3600 operating cycles/hour
 Mechanical endurance: 20 million operating cycles
 Max. actuation speed: 0.5 m/s
 Min. actuation speed: 1 mm/s (slow action)
 0.01 mm/s (snap action)

Tightening torque of the terminal screws: 0.6 ... 0.8 Nm

Wire cross-sections and wire stripping lengths:

see page 249 of the General Catalogue Detection 2023-2024

In compliance with standards:

IEC 60947-5-1, EN 60947-5-1, EN 60947-1, IEC 60204-1, EN 60204-1, EN ISO 14119, EN ISO 12100, IEC 60529, EN 60529, EN IEC 63000, UL 508, CSA C22.2 No. 14, GB/T14048.5.

Approvals:

UL 508, CSA C22.2 No. 14, EN 60947-1, EN 60947-5-1.

Compliance with the requirements of:

Low Voltage Directive 2014/35/EU,
 EMC Directive 2014/30/EU,
 RoHS Directive 2011/65/EU.

Positive contact opening in conformity with standards:

IEC 60947-5-1, EN 60947-5-1.

Installation for safety applications:

Use only switches marked with the ⊕ symbol beside the product code. Always connect the safety circuit to the **NC contacts** (normally closed contacts: 11-12, 21-22 or 31-32) as required by **EN ISO 14119, paragraph 5.4** for specific interlock applications and **EN ISO 13849-2 table D3** (well-tries components) and **D.8** (fault exclusions) for safety applications in general. Actuate the switch **at least up to the positive opening travel** reported in the travel diagrams. Actuate the switch **at least with the positive opening force**, reported in brackets below each article, next to the minimum force value.

⚠ **If not expressly indicated in this chapter, for correct installation and utilization of all articles see chapter Utilization requirements from page 227 to page 242 of the General Catalogue Detection 2023-2024.**

Electrical data

| | |
|--|-----------------------------|
| Thermal current (I _{th}): | 10 A |
| Rated insulation voltage (U _i): | 500 Vac 600 Vdc |
| Rated impulse withstand voltage (U _{imp}): | 6 kV |
| Conditional short circuit current: | 1000 A acc. to EN 60947-5-1 |
| Protection against short circuits: | type aM fuse 10 A 500 V |
| Pollution degree: | 3 |

Utilization category

| | | | |
|--------------------------------------|-----|------|-----|
| Alternating current: AC15 (50-60 Hz) | | | |
| U _e (V) | 250 | 400 | 500 |
| I _e (A) | 6 | 4 | 1 |
| Direct current: DC13 | | | |
| U _e (V) | 24 | 125 | 250 |
| I _e (A) | 3 | 0.55 | 0.3 |

Features approved by IMQ

Rated insulation voltage (U_i):
 500 Vac (for contact blocks [B] 5, 6, 7, 9, 10, 12, 13, 14, 15, 17, 18, 19, 66, 67)
 400 Vac (for contact blocks [B] 11, 37)
 Conventional free air thermal current (I_{th}): 10 A
 Protection against short circuits: type aM fuse 10 A 500 V
 Rated impulse withstand voltage (U_{imp}): 6 kV
 Protection degree of the housing: IP20
 MV terminals (screw terminals)
 Pollution degree: 3
 Utilization category: AC15
 Operating voltage (U_e): 400 Vac (50/60 Hz)
 Operating current (I_e): 4 A
 Forms of the contact element: Zb, Y+Y, X+X, Y, X
 Positive opening contacts on contact blocks [B] 5, 6, 7, 9, 11, 13, 14, 17, 18, 19, 37, 66
 In compliance with standards: EN 60947-1, EN 60947-5-1, fundamental requirements of the Low Voltage Directive 2014/35/EU.

Please contact our technical department for the list of approved products.

Features approved by UL

Electrical ratings: Q300 (69 VA, 125-250 Vdc)
 A600 (720 VA, 120-600 Vac)
 Housing features: open type.
 For all contact blocks use 60 or 75°C copper (Cu) conductors, rigid or flexible, wire size 12, 14 AWG.
 Tightening torque for terminal screws of 7.1 lb in (0.8 Nm).

Please contact our technical department for the list of approved products.



Description



Contact block with captive screws, finger protection and self-lifting clamping screw plates. Provided with positive opening NC contacts for safety applications. Provided with twin bridge contacts, they are particularly suitable for high-reliability applications. Suitable for installation inside PA, PX and PC series foot switches.

Dimensional drawings

All values in the drawings are in mm

Contact type:

- R** = snap action
- L** = slow action
- LO** = slow action, make before break
- LS** = slow action, shifted
- LV** = slow action, shifted and spaced
- LA** = slow action, close

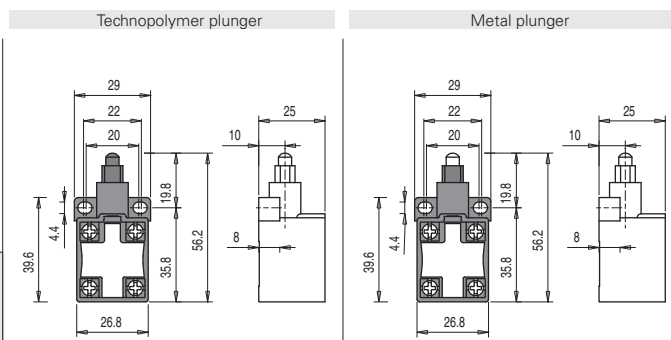

Legend

- Closed contact
- Open contact
- Positive opening travel acc. to IEC 60947-5-1
- Pressing the switch
- Releasing the switch

| Contact type | Technopolymer plunger | | Metal plunger | | Contact diagrams | Travel diagram |
|-----------------|-----------------------|----------|---------------|----------|------------------|----------------|
| | Article | Contacts | Article | Contacts | | |
| R | VF B501 | 1NO+1NC | VF B502 | 1NO+1NC | | |
| L | VF B601 | 1NO+1NC | VF B602 | 1NO+1NC | | |
| LO | VF B701 | 1NO+1NC | VF B702 | 1NO+1NC | | |
| L | VF B901 | 2NC | VF B902 | 2NC | | |
| L | VF B1001 | 2NO | VF B1002 | 2NO | | |
| R | VF B1101 | 2NC | VF B1102 | 2NC | | |
| R | VF B1201 | 2NO | VF B1202 | 2NO | | |
| LV | VF B1301 | 2NC | VF B1302 | 2NC | | |
| LS | VF B1401 | 2NC | VF B1402 | 2NC | | |
| LS | VF B1501 | 2NO | VF B1502 | 2NO | | |
| LA | VF B1801 | 1NO+1NC | VF B1802 | 1NO+1NC | | |
| L | VF B3701 | 1NO+1NC | VF B3702 | 1NO+1NC | | |
| L | VF B6601 | 1NC | VF B6602 | 1NC | | |
| L | VF B6701 | 1NO | VF B6702 | 1NO | | |
| Max. speed | 0,5 m/s | | 0,5 m/s | | | |
| Actuating force | 8 N (20 N | | 8 N (20 N | | | |

Code structure

article options
VF B501-G

Contact blocks

| | |
|-----------|---|
| 5 | 1NO+1NC, snap action |
| 6 | 1NO+1NC, slow action |
| 7 | 1NO+1NC, slow action, make before break |
| 9 | 2NC, slow action |
| 10 | 2NO, slow action |
| 11 | 2NC, snap action |
| 12 | 2NO, snap action |
| ... | ... |

Contact type

| | |
|-----------|--|
| | silver contacts (standard) |
| G | silver contacts with 1 µm gold coating |
| G1 | silver contacts with 2.5 µm gold coating |

Actuators

| | |
|-----------|---------------------------------------|
| 01 | with technopolymer plunger (standard) |
| 02 | with metal plunger |

→ The 2D and 3D files are available at www.pizzato.com

EROUND line introduction

Design and maximum reliability

Pizzato Elettrica's innovative EROUND control and signalling devices combine elegance and functionality in a single product.

The ergonomic design allows a comfortable and easy use of the devices. The details have been carefully designed giving the products a pleasant appearance and making them suitable for applications also on well designed machinery.

The devices of the EROUND line, thanks to their design and functionality, guarantee maximum reliability, and are suitable for any type of application.



A complete range of products



Designed for improving the functions of our existing products already present in the market, the control and signalling devices of the EROUND line are provided with technical features that make this series one of the most complete in the industrial safety sector.

Thanks to the design, the care for details and the elegance of the product combined with its maximum safety and reliability, this series is one of the most cutting-edge on the market.

Safety at a glance



Thanks to the chosen shapes, the employed materials and the use of high luminosity LEDs, the illuminated devices of the EROUND line guarantee greater safety increasing thus the signalling and visibility level in any situation.

Laser engraving

Pizzato Elettrica introduced a laser engraving system for the control and signalling devices of the EROUND line, where the use of pad printing has been eliminated to guarantee that the marking on the product is indelible.

Furthermore, in case of machineries subjected to intense washing with high pressure water jets, there is no risk of inscriptions becoming illegible over time.



Maximum protection

All control and signalling devices of the EROUND line are provided with an IP67 protection degree. This makes it possible to install them in any type of application, also in the most difficult environment conditions.

Most devices, not only have an IP67 protection degree, but have also passed the test proving their IP69K protection degree according to the prescriptions established by the ISO 20653 standard.

Therefore they are suitable for use in machineries subjected to intense washing with high pressure and high temperature water jets and for any condition or environment where a particular attention for cleanness and hygiene is required.



Guaranteed resistance

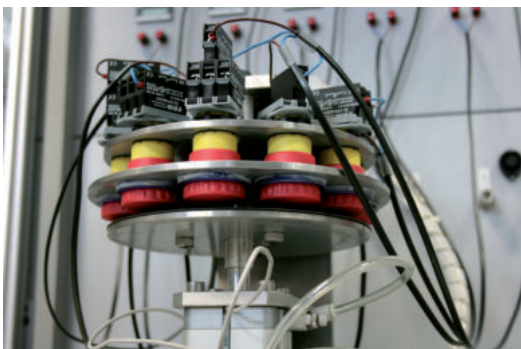

Pizzato Elettrica has tested the control and signalling devices of the EROUND line according to the specific tests of the EN 60947-5-1 standard.

The particular design and the choice of employed materials made it possible to achieve considerable mechanical durability, which is expressed in number of cycles the articles have been subjected to: among the various tested products, the contact blocks reached and exceeded 20 million cycles, the buttons 15 million cycles, and the emergency stop buttons 300,000 cycles.

EROUND line selection diagram

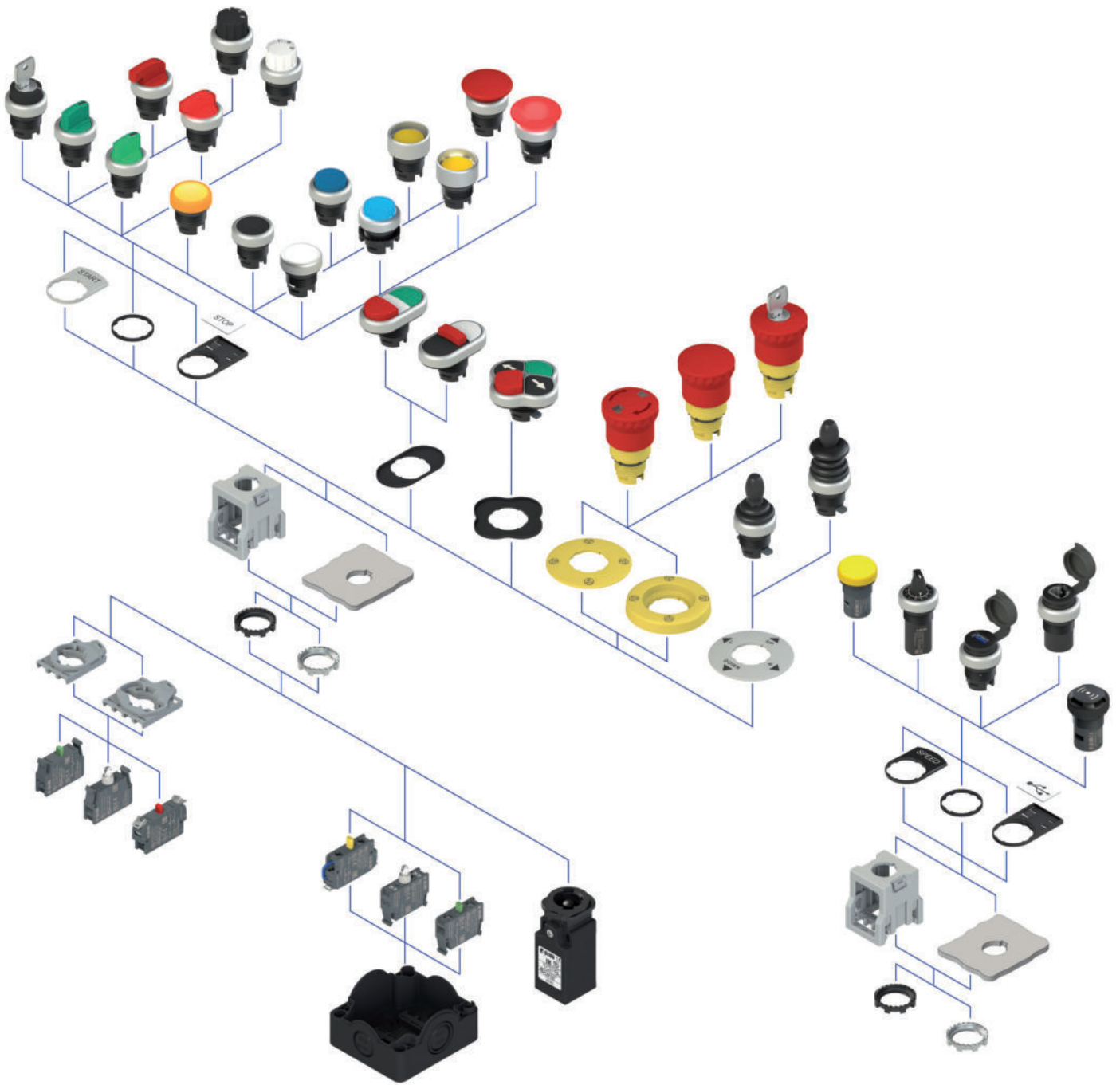

Selection diagram

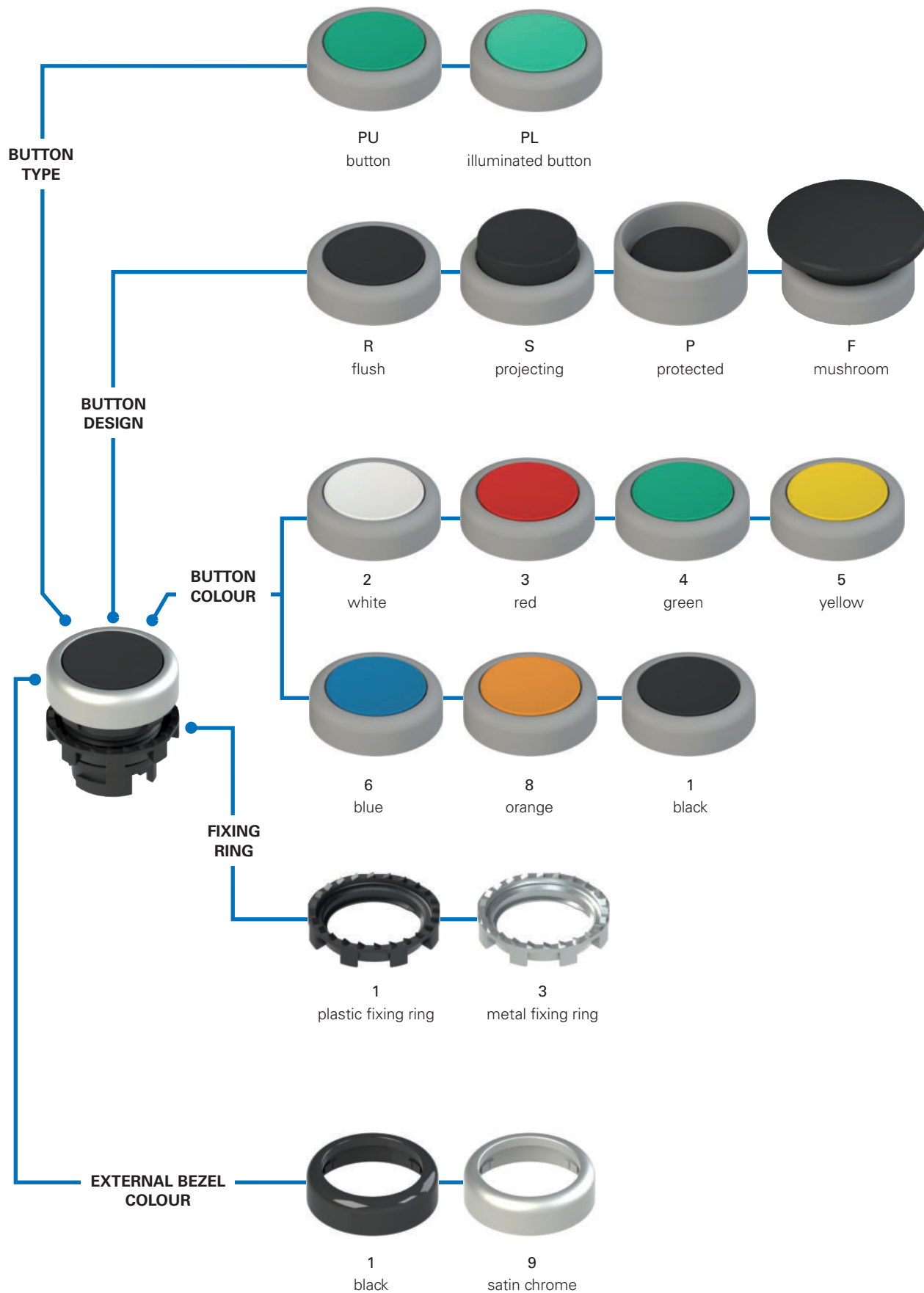

Code structure for buttons

Attention! The feasibility of a code number does not mean the effective availability of a product. Please contact our sales office.

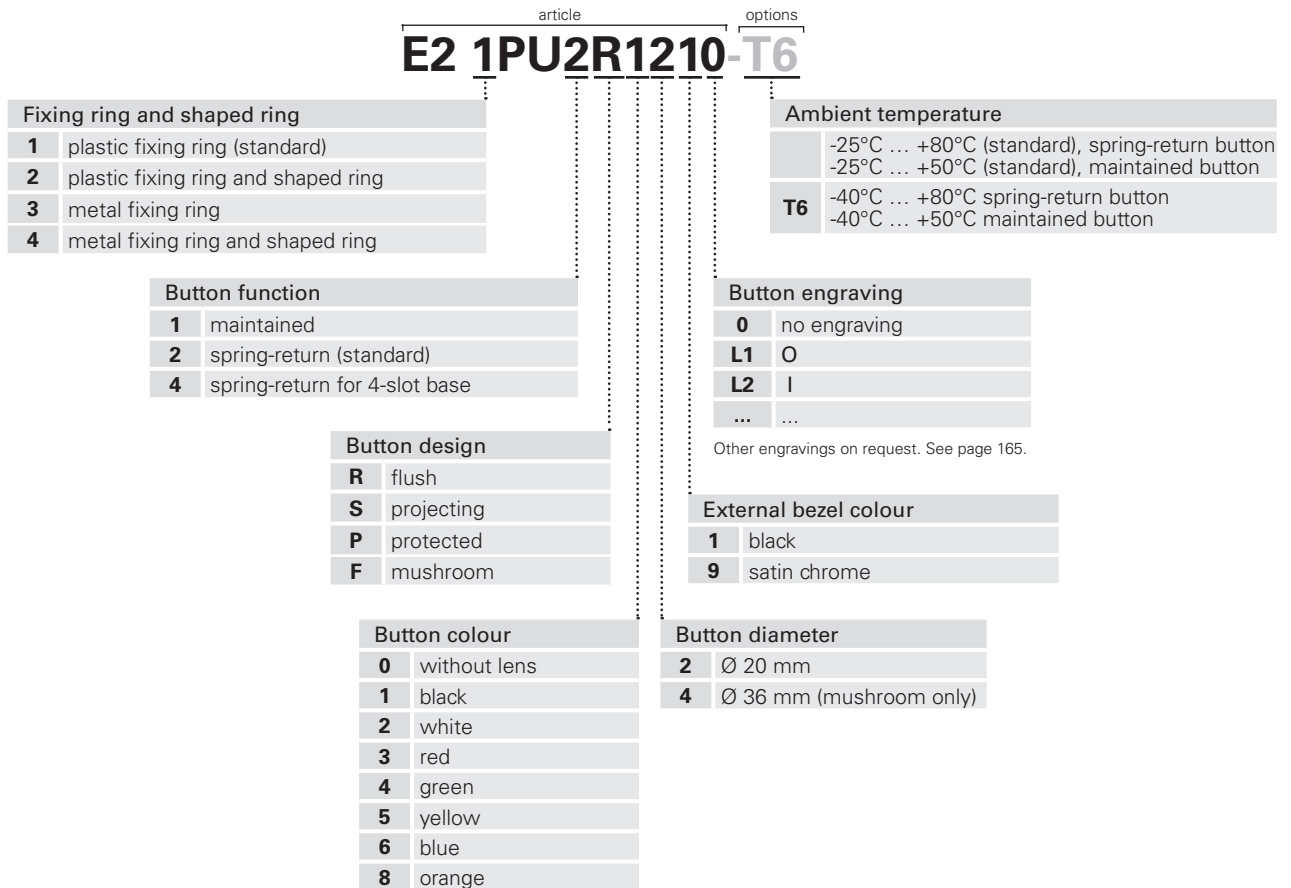

Code structure for illuminated buttons

Attention! The feasibility of a code number does not mean the effective availability of a product. Please contact our sales office.

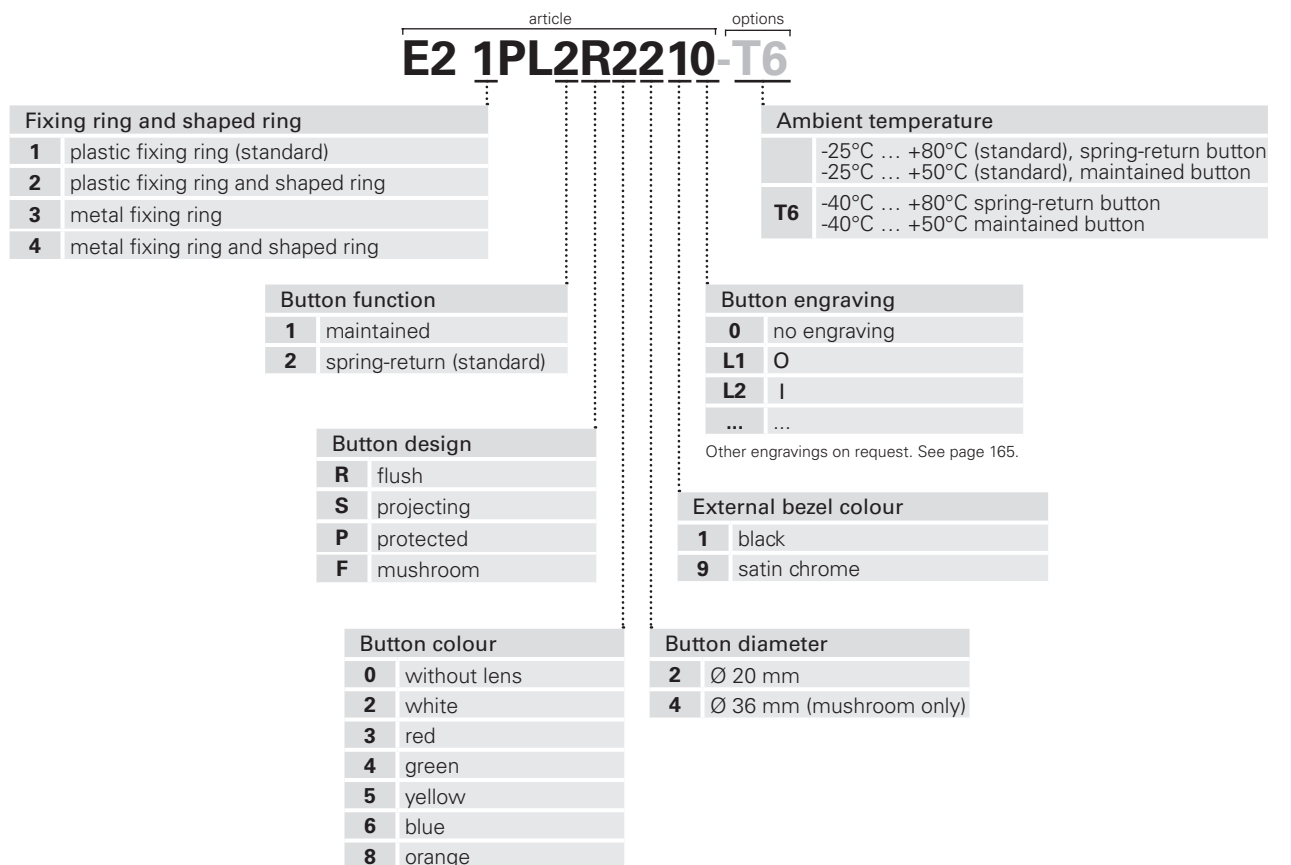



Main features

- Protection degrees IP67 and IP69K
- 4 different shapes
- 7 colours available
- -40°C versions
- Maintained or spring-return version

Quality marks:



IMQ approval: CA02.04805
 UL approval: E131787
 EAC approval: RU C-IT.YT03.B.00035/19

Technical data

General data

| | |
|---------------------------------------|--|
| Protection degree: | IP67 acc. to EN 60529 IP69K acc. to ISO 20653 |
| Ambient temperature: | -25°C ... +80°C (standard) -40°C ... +80°C (T6 option) |
| Spring-return button | |
| Maintained button | -25°C ... +50°C (standard) -40°C ... +50°C (T6 option) |
| Safety parameter B _{10D} : | 30,000,000 (spring-return button) 2,000,000 (maintained button) |
| Mechanical endurance: | 15 million operating cycles (spring-return button) 1 million operating cycles (maintained button) |
| Max. actuation frequency: | 3600 operating cycles/hour |
| Actuating force at limit of travel: | 3.7 N (without contacts) (spring-return button) 4.4 N (without contacts) (maintained button) |
| Maximum travel: | 5 mm |
| Tightening torque of the fixing ring: | 2 ... 2.5 Nm |
| Utilization requirements: | see page 169 |

In compliance with standards:

IEC 60947-1, IEC 60947-5-1, IEC 60204-1, EN 60947-1, EN 60947-5-1, EN 60204-1, EN IEC 63000, UL 508, CSA C22.2 No. 14.

⚠ Installation for safety applications:

Use only contact blocks marked with the symbol ⊕. The safety circuit must always be connected to **NC contacts** (normally closed contacts: .1-2)

Compliance with the requirements of:

Low Voltage Directive 2014/35/EU, EMC Directive 2014/30/EU, RoHS Directive 2011/65/EU

Positive contact opening in conformity with standards:

IEC 60947-5-1, EN 60947-5-1.

Features approved by UL

For Use on a Flat Surface of a Type 1, 4X, 12 and 13
 Tightening torque 2.0 Nm

General data

Protection degrees IP67 and IP69K

IP69K
IP67

These devices are designed to be used under the toughest environmental conditions, and they pass the IP67 immersion test acc. to EN 60529. They can therefore be used in all environments where the maximum degree of protection is required for the housing. Due to

their special design, these devices are suitable for use in equipment subjected to cleaning with high pressure hot water jets. These devices meet the IP69K test requirements according to ISO 20653 (water jets with 100 bar and 80°C).

Metal fixing ring



The fixing ring in metal is particularly suitable for those applications which require tighter fitting of the panel-mounted device, such as for example in metal panels having holes without reference notches.

Shaped ring

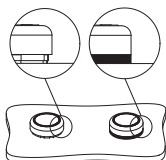

The shaped ring can be used when no label holder or other devices are applied; it prevents dirt and other residues from settling between the button and the panel or housing.

This turns out to be particularly useful in the sectors where high standards of cleanness and hygiene are required.

Functions

Depending on the type of application, the EROUND line buttons of Pizzato Elettrica are available in two versions: the one with maintained function (once the button is pressed, a second manual intervention is necessary for unlocking) and the one with spring-return function (the button is not maintained locked).



Customisable



In order to satisfy various customer requests and demands, Pizzato Elettrica offers the possibility to customize the control and signalling devices of the EROUND line: the bezels can be requested with different colours (black and satin chrome), whereas the lenses can be customized with a wide range of writings, symbols, and colours.

Extended temperature range









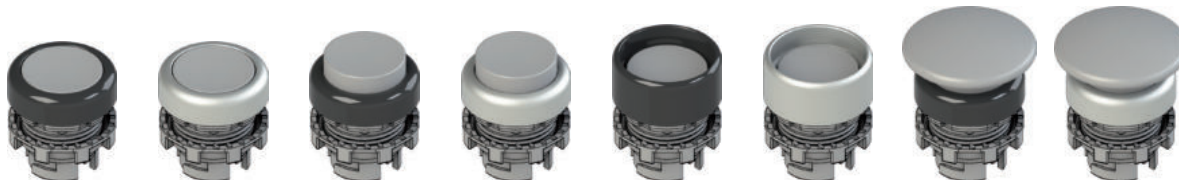



-40°C

These devices are also available in a special version suitable for an ambient operating temperature range from -40°C up to +80°C.

They can therefore be used for applications in cold stores, sterilisers and other equipment with low temperature environments. The special materials used to produce these versions retain their characteristics even under these conditions, thereby expanding the installation possibilities.

Selection table for buttons











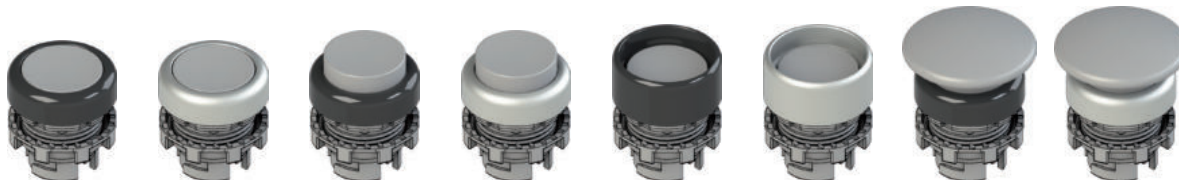

| Colour and engraving actuator | Flush | | Projecting | | Protected | | Mushroom | |
|--|---------------|------------------|----------------------------|----------------------------|---------------|------------------|---------------|------------------|
| | black bezel | satin chr. bezel | black bezel | satin chr. bezel | black bezel | satin chr. bezel | black bezel | satin chr. bezel |
|  without lens | E2 1PU2R0210 | E2 1PU2R0290 | Same article, flush button | Same article, flush button | E2 1PU2P0210 | E2 1PU2P0290 | - | - |
|  black | E2 1PU2R1210 | E2 1PU2R1290 | E2 1PU2S1210 | E2 1PU2S1290 | E2 1PU2P1210 | E2 1PU2P1290 | E2 1PU2F1410 | E2 1PU2F1490 |
|  white | E2 1PU2R2210 | E2 1PU2R2290 | E2 1PU2S2210 | E2 1PU2S2290 | E2 1PU2P2210 | E2 1PU2P2290 | E2 1PU2F2410 | E2 1PU2F2490 |
|  red | E2 1PU2R3210 | E2 1PU2R3290 | E2 1PU2S3210 | E2 1PU2S3290 | E2 1PU2P3210 | E2 1PU2P3290 | E2 1PU2F3410 | E2 1PU2F3490 |
|  green | E2 1PU2R4210 | E2 1PU2R4290 | E2 1PU2S4210 | E2 1PU2S4290 | E2 1PU2P4210 | E2 1PU2P4290 | E2 1PU2F4410 | E2 1PU2F4490 |
|  yellow | E2 1PU2R5210 | E2 1PU2R5290 | E2 1PU2S5210 | E2 1PU2S5290 | E2 1PU2P5210 | E2 1PU2P5290 | E2 1PU2F5410 | E2 1PU2F5490 |
|  blue | E2 1PU2R6210 | E2 1PU2R6290 | E2 1PU2S6210 | E2 1PU2S6290 | E2 1PU2P6210 | E2 1PU2P6290 | E2 1PU2F6410 | E2 1PU2F6490 |
|  orange | E2 1PU2R8210 | E2 1PU2R8290 | E2 1PU2S8210 | E2 1PU2S8290 | E2 1PU2P8210 | E2 1PU2P8290 | E2 1PU2F8410 | E2 1PU2F8490 |
|  red | E2 1PU2R321L1 | E2 1PU2R329L1 | E2 1PU2S321L1 | E2 1PU2S329L1 | - | - | E2 1PU2F341L1 | E2 1PU2F349L1 |
|  green | E2 1PU2R421L2 | E2 1PU2R429L2 | E2 1PU2S421L2 | E2 1PU2S429L2 | E2 1PU2P421L2 | E2 1PU2P429L2 | E2 1PU2F441L2 | E2 1PU2F449L2 |
|  black | E2 1PU2R121L1 | E2 1PU2R129L1 | E2 1PU2S121L1 | E2 1PU2S129L1 | - | - | E2 1PU2F141L1 | E2 1PU2F149L1 |
|  white | E2 1PU2R221L2 | E2 1PU2R229L2 | E2 1PU2S221L2 | E2 1PU2S229L2 | E2 1PU2P221L2 | E2 1PU2P229L2 | E2 1PU2F241L2 | E2 1PU2F249L2 |

For ordering a maintained button replace 1PU2 with 1PU1 in the respective article code.

Example: E2 1PU2R0210 → E2 1PU1R0210

Selection table for illuminated buttons



| Actuator colour and engraving | Flush | | Projecting | | Protected | | Mushroom | |
|--|---------------|------------------|----------------------------|----------------------------|---------------|------------------|---------------|------------------|
| | black bezel | satin chr. bezel | black bezel | satin chr. bezel | black bezel | satin chr. bezel | black bezel | satin chr. bezel |
|  without lens | E2 1PL2R0210 | E2 1PL2R0290 | Same article, flush button | Same article, flush button | E2 1PL2P0210 | E2 1PL2P0290 | - | - |
|  white | E2 1PL2R2210 | E2 1PL2R2290 | E2 1PL2S2210 | E2 1PL2S2290 | E2 1PL2P2210 | E2 1PL2P2290 | E2 1PL2F2410 | E2 1PL2F2490 |
|  red | E2 1PL2R3210 | E2 1PL2R3290 | E2 1PL2S3210 | E2 1PL2S3290 | E2 1PL2P3210 | E2 1PL2P3290 | E2 1PL2F3410 | E2 1PL2F3490 |
|  green | E2 1PL2R4210 | E2 1PL2R4290 | E2 1PL2S4210 | E2 1PL2S4290 | E2 1PL2P4210 | E2 1PL2P4290 | E2 1PL2F4410 | E2 1PL2F4490 |
|  yellow | E2 1PL2R5210 | E2 1PL2R5290 | E2 1PL2S5210 | E2 1PL2S5290 | E2 1PL2P5210 | E2 1PL2P5290 | E2 1PL2F5410 | E2 1PL2F5490 |
|  blue | E2 1PL2R6210 | E2 1PL2R6290 | E2 1PL2S6210 | E2 1PL2S6290 | E2 1PL2P6210 | E2 1PL2P6290 | E2 1PL2F6410 | E2 1PL2F6490 |
|  orange | E2 1PL2R8210 | E2 1PL2R8290 | E2 1PL2S8210 | E2 1PL2S8290 | E2 1PL2P8210 | E2 1PL2P8290 | E2 1PL2F8410 | E2 1PL2F8490 |
|  red | E2 1PL2R321L1 | E2 1PL2R329L1 | E2 1PL2S321L1 | E2 1PL2S329L1 | - | - | E2 1PL2F341L1 | E2 1PL2F349L1 |
|  green | E2 1PL2R421L2 | E2 1PL2R429L2 | E2 1PL2S421L2 | E2 1PL2S429L2 | E2 1PL2P421L2 | E2 1PL2P429L2 | E2 1PL2F441L2 | E2 1PL2F449L2 |
| white | E2 1PL2R221L1 | E2 1PL2R229L1 | E2 1PL2S221L1 | E2 1PL2S229L1 | - | - | E2 1PL2F241L1 | E2 1PL2F249L1 |
| white | E2 1PL2R221L2 | E2 1PL2R229L2 | E2 1PL2S221L2 | E2 1PL2S229L2 | E2 1PL2P221L2 | E2 1PL2P229L2 | E2 1PL2F241L2 | E2 1PL2F249L2 |

For ordering a maintained button replace 1PL2 with 1PL1 in the respective article code.

Example: E2 1PL2R0210 → E2 1PL1R0210

Complete units with buttons

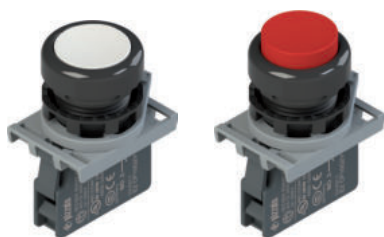

| Colour and engraving actuator | Contacts | | | Flush | |
|-------------------------------|----------|--------|--------|--|--|
| | pos. 2 | pos. 3 | pos. 1 | black bezel | |
| black | - | 1NO | - | E2 AC-DXBC1204 E2 1PU2R1210 + E2 1BAC11 + E2 CP10G2V1 | |
| white | - | 1NO | - | E2 AC-DXBC1200 E2 1PU2R2210 + E2 1BAC11 + E2 CP10G2V1 | |
| red | - | 1NC | - | E2 AC-DXBC1208 E2 1PU2R3210 + E2 1BAC11 + E2 CP01G2V1 | E2 AC-DXBC1209 E2 1PU2S3210 + E2 1BAC11 + E2 CP01G2V1 |
| green | - | 1NO | - | E2 AC-DXBC1201 E2 1PU2R4210 + E2 1BAC11 + E2 CP10G2V1 | |
| yellow | - | 1NO | - | E2 AC-DXBC1206 E2 1PU2R5210 + E2 1BAC11 + E2 CP10G2V1 | |
| blue | - | 1NO | - | E2 AC-DXBC1207 E2 1PU2R6210 + E2 1BAC11 + E2 CP10G2V1 | |
| red | - | 1NC | - | E2 AC-DXBC1211 E2 1PU2R321L1 + E2 1BAC11 + E2 CP01G2V1 | E2 AC-DXBC1212 E2 1PU2S321L1 + E2 1BAC11 + E2 CP01G2V1 |
| green | - | 1NO | - | E2 AC-DXBC1210 E2 1PU2R421L2 + E2 1BAC11 + E2 CP10G2V1 | |
| black | - | 1NC | - | E2 AC-DXBC1227 E2 1PU2R121L1 + E2 1BAC11 + E2 CP01G2V1 | |
| white | - | 1NO | - | E2 AC-DXBC1226 E2 1PU2R221L2 + E2 1BAC11 + E2 CP10G2V1 | |

Other combinations on request.

→ For data regarding contact blocks and LED units, please see the respective chapters.

Complete units with illuminated buttons



| Colour and engraving actuator | Contacts | | | Flush | |
|-------------------------------|----------|--------|--------|--|--|
| | pos. 2 | pos. 3 | pos. 1 | black bezel | |
| white | 1NC | LED | 1NO | E2 AC-DXBC0400 E2 1PL2R2210 + E2 1BAC11 + E2 CP01G2V1 + E2 LP1A2V1 + E2 CP10G2V1 | |
| red | 1NC | LED | 1NO | E2 AC-DXBC0402 E2 1PL2R3210 + E2 1BAC11 + E2 CP01G2V1 + E2 LP1A3V1 + E2 CP10G2V1 | |
| green | 1NC | LED | 1NO | E2 AC-DXBC0401 E2 1PL2R4210 + E2 1BAC11 + E2 CP01G2V1 + E2 LP1A4V1 + E2 CP10G2V1 | |
| yellow | 1NC | LED | 1NO | E2 AC-DXBC0404 E2 1PL2R5210 + E2 1BAC11 + E2 CP01G2V1 + E2 LP1A2V1 + E2 CP10G2V1 | |
| blue | 1NC | LED | 1NO | E2 AC-DXBC0403 E2 1PL2R6210 + E2 1BAC11 + E2 CP01G2V1 + E2 LP1A6V1 + E2 CP10G2V1 | |

Other combinations on request.

Dimensional drawings

All values in the drawings are in mm

Flush button

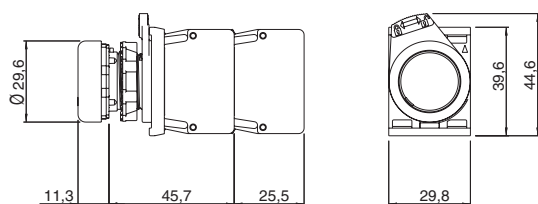

Projecting button

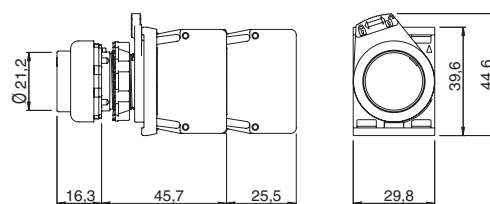

Protected button

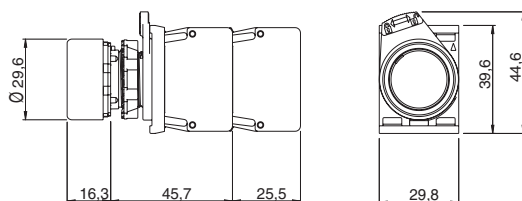

Mushroom button

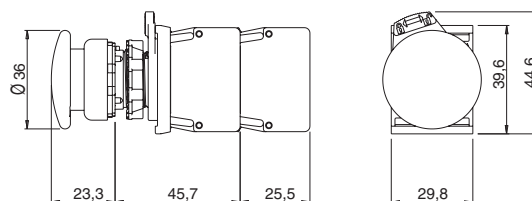





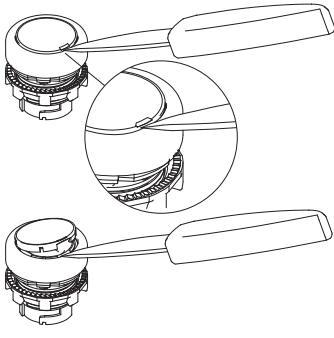

























→ The 2D and 3D files are available at www.pizzato.com

Lenses for E2 •PU buttons and E2 •PL illuminated buttons



















The buttons and the illuminated buttons feature replaceable lenses.
To remove the lenses, leverage them with a pointed object near the reference notch on the external diameter of the lens itself.



| Lenses without engraving | | | | |
|--------------------------|---|---|--|---|
| Article | Type | Description | Colours | Pieces/ package |
| VE LP21R10 |  | Lens for flush button, black, without engraving |  | 10 |
| VE LP22R20 | | Lens for flush button, white, without engraving |  | 10 |
| VE LP22R30 | | Lens for flush button, red, without engraving |  | 10 |
| VE LP22R40 | | Lens for flush button, green, without engraving |  | 10 |
| VE LP22R50 | | Lens for flush button, yellow, without engraving |  | 10 |
| VE LP22R60 | | Lens for flush button, blue, without engraving |  | 10 |
| VE LP22R80 | | Lens for flush button, orange, without engraving |  | 10 |
| VE LP22RA0 | | | 7 lenses for flush button without engraving, colours: black, white, red, green, yellow, blue and orange |        |
| VE LP21S10 |  | Lens for projecting button, black, without engraving |  | 10 |
| VE LP22S20 | | Lens for projecting button, white, without engraving |  | 10 |
| VE LP22S30 | | Lens for projecting button, red, without engraving |  | 10 |
| VE LP22S40 | | Lens for projecting button, green, without engraving |  | 10 |
| VE LP22S50 | | Lens for projecting button, yellow, without engraving |  | 10 |
| VE LP22S60 | | Lens for projecting button, blue, without engraving |  | 10 |
| VE LP22S80 | | Lens for projecting button, orange, without engraving |  | 10 |
| VE LP22SA0 | | | 7 lenses for protruding button without engraving, colours: black, white, red, green, yellow, blue and orange |        |



| Lenses with engraving | | | | |
|-----------------------|---|---|---|---|
| Article | Type | Description | Colours | Pieces/ Pack |
| VE LP21R1●●● |  | Lens for flush button, black, with engraving |  | 1 |
| VE LP22R2●●● | | Lens for flush button, white, with engraving |  | 1 |
| VE LP22R3●●● | | Lens for flush button, red, with engraving |  | 1 |
| VE LP22R4●●● | | Lens for flush button, green, with engraving |  | 1 |
| VE LP22R5●●● | | Lens for flush button, yellow, with engraving |  | 1 |
| VE LP22R6●●● | | Lens for flush button, blue, with engraving |  | 1 |
| VE LP22R8●●● | | Lens for flush button, orange, with engraving |  | 1 |
| VE LP21S1●●● | |  | Lens for projecting button, black, with engraving |  |
| VE LP22S2●●● | Lens for projecting button, white, with engraving | |  | 1 |
| VE LP22S3●●● | Lens for projecting button, red, with engraving | |  | 1 |
| VE LP22S4●●● | Lens for projecting button, green, with engraving | |  | 1 |
| VE LP22S5●●● | Lens for projecting button, yellow, with engraving | |  | 1 |
| VE LP22S6●●● | Lens for projecting button, blue, with engraving | |  | 1 |
| VE LP22S8●●● | Lens for projecting button, orange, with engraving | |  | 1 |

The black lens cannot be used with illuminated buttons.

For ordering lenses for buttons with marking:
replace the dots ●●● in the article codes with the marking code reported on the table at page 165.
Example: white lens for flush button with "O" engraving.
VE LP22R2●●● → VE LP22R2L1

Minimum distances for installation

All values in the drawings are in mm

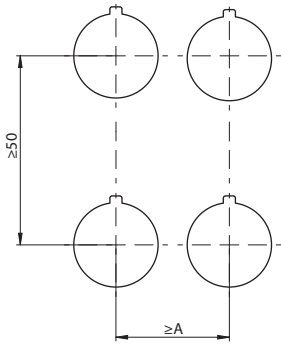

| 3-slot mounting adapter | |
|-------------------------|-------|
| Button type | A |
| flush | 30 mm |
| projecting | 30 mm |
| protected | 30 mm |
| mushroom | 40 mm |

| 4-slot mounting adapter | |
|-------------------------|-------|
| Button type | A |
| flush | 40 mm |
| projecting | 40 mm |
| protected | 40 mm |
| mushroom | 40 mm |

Maximum number of contact blocks

3-slot mounting adapter

4-slot mounting adapter

Spring-return buttons
E2 •PU2•••••

Maintained buttons
E2 •PU1•••••

Illuminated spring-return buttons
E2 •PL2•••••

Illuminated maintained buttons
E2 •PL1•••••

Spring-return buttons
E2 •PU4•••••

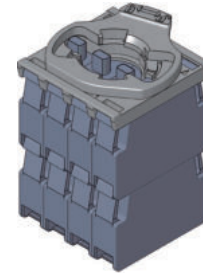
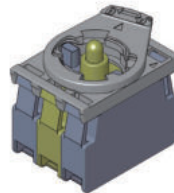
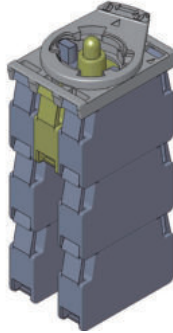
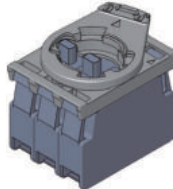
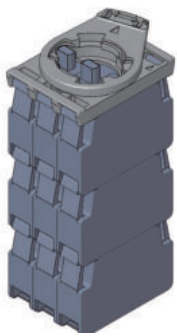

maximum number:
9 contact blocks
3 levels

maximum number:
3 contact blocks
1 level

maximum number:
6 contact blocks
3 levels

maximum number:
2 contact blocks
1 level

maximum number:
8 contact blocks
2 levels

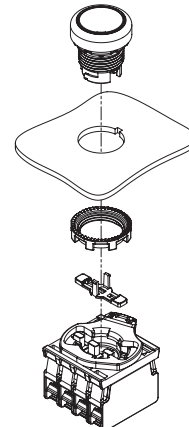
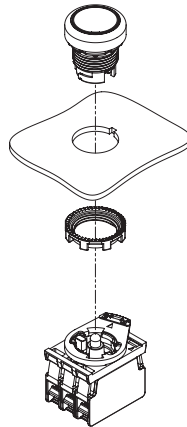
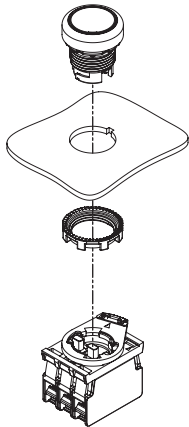

Contact block



LED unit

The mounting of the actuator for 4-slot base must be carried out after fixing the button.

Closing cap Packs of **10 pcs.**



| Article | Description |
|-----------|--|
| VE AS1211 | Central closing cap for illuminated button E2 •PL●●●●●●. For 3-slot mounting adapters. |

It closes the central hole of the illuminated button and makes it possible to actuate a contact instead of the LED.

Actuator for 4-slot base Packs of **10 pcs.**

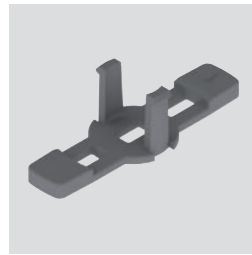

| Article | Description |
|-----------|---|
| VE AS1218 | Closed long actuator for 4-slot mounting adapter. It must be installed after fixing the button to the wall. For E2 •PU●●●●●● buttons |

Shaped ring Packs of **50 pcs.**



| Article | Description |
|------------|-------------------------------|
| VE GP12H1A | Shaped ring for single device |

Not applicable in presence of label holders, adapters from Ø 22 to Ø 30 mm, guards or protection caps.

Protection cap Packs of **10 pcs.**



| Article | Description |
|----------|--|
| VE CA1A1 | Protection cap for flush button (panel width from 1 to 5 mm) |
| VE CA1B1 | Protection cap for single projecting button (panel width from 1 to 5 mm) |

Not applicable in presence of shaped rings, label holders, adapters from Ø 22 to Ø 30 mm or protection guards.

Fixing ring Packs of **20 pcs.**



| Article | Description |
|-----------|-------------------|
| VE GF720A | Metal fixing ring |

Accessories

➔ More ACCESSORIES on page 161

Selection diagram

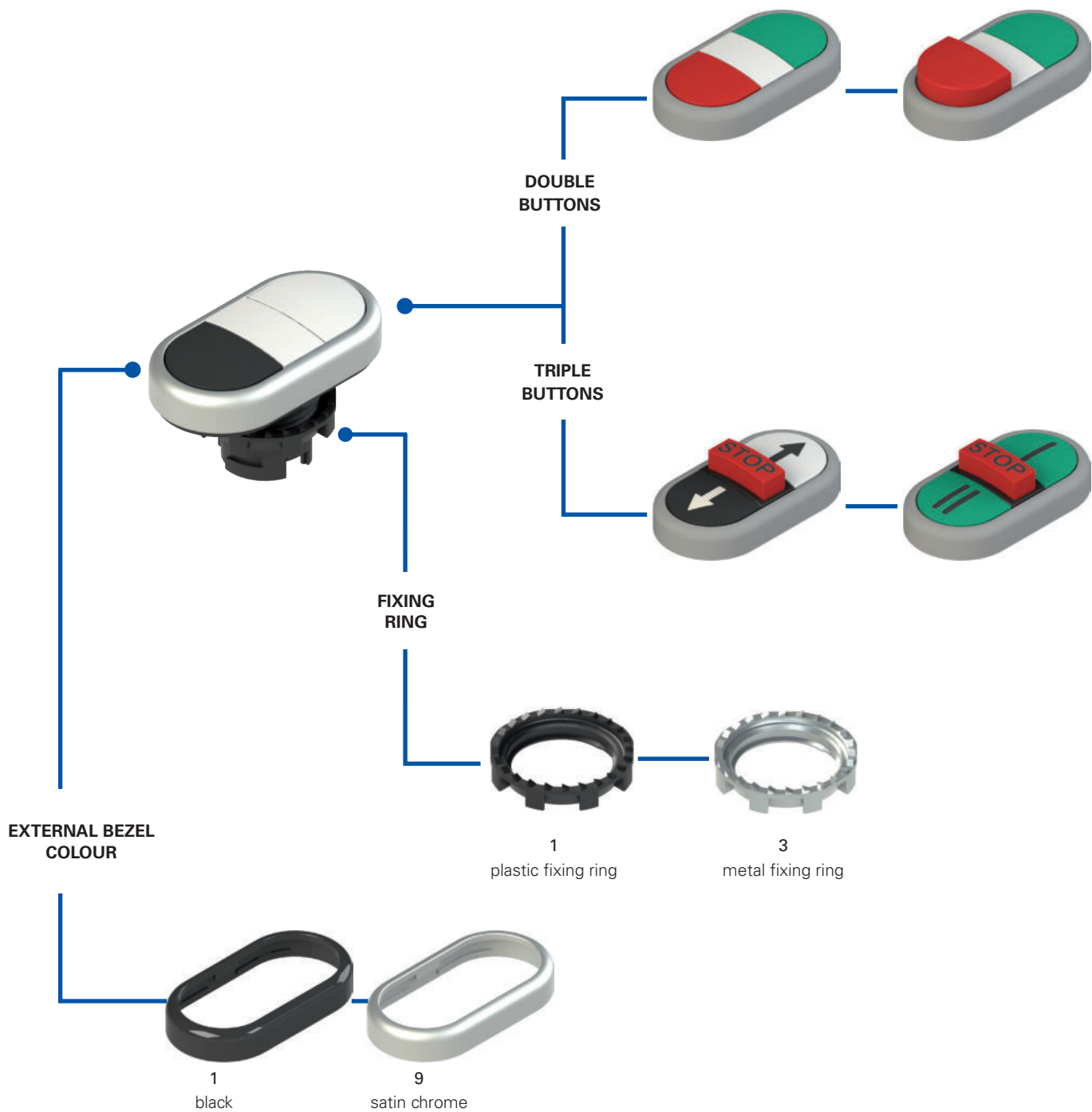

Code structure **Attention!** The feasibility of a code number does not mean the effective availability of a product. Please contact our sales office.

article options
E2 1PDRL10423-T6

| Fixing ring and shaped ring | |
|-----------------------------|-------------------------------------|
| 1 | plastic fixing ring (standard) |
| 2 | plastic fixing ring and shaped ring |
| 3 | metal fixing ring |
| 4 | metal fixing ring and shaped ring |

| Ambient temperature | |
|---------------------|----------------------------|
| | -25°C ... +80°C (standard) |
| T6 | -40°C ... +80°C |

| No. of functions | |
|------------------|---------------|
| D | Double button |
| T | triple button |

| Upper and lower button | |
|------------------------|------------------------------------|
| A | upper projecting, lower flush |
| B | upper projecting, lower projecting |
| R | upper flush, lower flush |
| S | upper flush, lower projecting |

| Intermediate element | |
|----------------------|---|
| L | backlit cap (only double buttons) |
| S | projecting button (triple buttons only) |
| Q | cap and actuators for 4-slot base (double buttons only) |

| Bezel colour | |
|--------------|-------------------------|
| 1 | black (standard) |
| 9 | satin chrome (standard) |

| | upper button | | central cap | | lower button | |
|-------------|--------------|--------|-------------|--------|--------------|--------|
| | colour | symbol | colour | symbol | colour | symbol |
| 0423 | green | - | white | - | red | - |
| 0221 | white | - | white | - | black | - |
| 0222 | white | - | white | - | white | - |
| 0121 | black | - | white | - | black | - |

Other combinations on request.

| | upper button | | central cap | | lower button | |
|-------------|--------------|--------------|-------------|--------|--------------|-------------|
| | colour | symbol | colour | symbol | colour | symbol |
| AAAD | green | I | white | - | red | O |
| AAAP | green | START | white | - | red | STOP |
| AAAA | white | I | white | - | black | O |
| AAAN | white | START | white | - | black | STOP |
| AAAB | black | ↑ | white | - | black | ↓ |
| AAAC | black | + | white | - | black | - |

Other combinations on request.

| | upper button | | central button projecting | | lower button | |
|-------------|--------------|----------|---------------------------|-------------|--------------|-----------|
| | colour | symbol | colour | symbol | colour | symbol |
| AAAY | green | I | red | STOP | green | II |
| AAAZ | green | ← | red | STOP | green | → |
| AABD | white | → | red | STOP | black | ← |
| AABA | green | ↑ | red | STOP | green | ↓ |
| AABE | white | ↑ | red | STOP | black | ↓ |
| AABF | black | ↑ | red | STOP | black | ↓ |
| AABB | green | + | red | STOP | green | - |
| AABC | white | + | red | STOP | white | - |

Other combinations on request.



Main features

- Protection degrees IP67 and IP69K
- Version with 2 or 3 buttons
- -40 °C version
- Version with central backlit cap

Quality marks:



IMQ approval: CA02.04805
 UL approval: E131787
 EAC approval: RU C-IT.YT03.B.00035/19

Technical data

General data

| | |
|---------------------------------------|---|
| Protection degree: | IP67 acc. to EN 60529 IP69K acc. to ISO 20653 |
| Ambient temperature: | -25°C ... +80°C (standard) -40°C ... +80°C (T6 option) |
| Safety parameter B_{10D} : | 2,000,000 |
| Mechanical endurance: | 1 million operating cycles |
| Max. actuation frequency: | 3600 operating cycles/hour |
| Actuating force at limit of travel: | 4.4 N (without contacts) |
| Maximum travel: | 5 mm |
| Tightening torque of the fixing ring: | 2 ... 2.5 Nm |
| Utilization requirements: | see page 169 |

In compliance with standards:

IEC 60947-1, IEC 60947-5-1, IEC 60204-1, EN 60947-1, EN 60947-5-1, EN 60204-1, EN IEC 63000, UL 508, CSA C22.2 No. 14.

⚠ Installation for safety applications:

Use only contact blocks marked with the symbol . The safety circuit must always be connected to **NC contacts** (normally closed contacts: .1-2).

Compliance with the requirements of:

Low Voltage Directive 2014/35/EU,
 EMC Directive 2014/30/EU,
 RoHS Directive 2011/65/EU.

Positive contact opening in conformity with standards:

IEC 60947-5-1, EN 60947-5-1.

Features approved by UL

For Use on a Flat Surface of a Type 1, 4X, 12 and 13
 Tightening torque 2.0 Nm

General data

Button profile

In order to be used in different types of application, the EROUND line double and triple buttons are now available in two shapes: projecting and flush. The possible choice of shapes, colours and symbols allows various code combinations for buttons.

Illuminated version

For double buttons, the version with central backlit cap is available.

Metal fixing ring



The fixing ring in metal is particularly suitable for those applications which require tighter fitting of the panel-mounted device, such as for example in metal panels having holes without reference notches.

Shaped ring

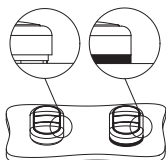

The shaped ring can be used when no label holder or other devices are applied; it prevents dirt and other residues from settling between the button and the panel or housing.

This turns out to be particularly useful in the sectors where high standards of cleanness and hygiene are required.

Customisable



In order to satisfy various customer requests and demands, Pizzato Elettrica offers the possibility to customize the control and signalling devices of the EROUND line: the bezels can be requested with different colours (black or satin chrome), whereas the lenses can be customized with a wide range of writings, symbols, and colours.

Protection degrees IP67 and IP69K

IP69K
IP67

These devices are designed to be used under the toughest environmental conditions, and they pass the IP67 immersion test acc. to EN 60529. They can therefore be used in all environments where the maximum degree of protection is required for the housing. Due to their special design, these devices are suitable for use in equipment subjected to cleaning with high pressure hot water jets. These devices meet the IP69K test requirements according to ISO 20653 (water jets with 100 bar and 80°C).

Extended temperature range







-40°C

These devices are also available in a special version suitable for an ambient operating temperature range from -40°C up to +80°C.

They can therefore be used for applications in cold stores, sterilisers and other equipment with low temperature environments. The special materials used to produce these versions retain their characteristics even under these conditions, thereby expanding the installation possibilities.

Selection table for double buttons







| Actuator colour and engraving | | upper button flush central cap, flush lower button flush | | upper button flush central cap, flush lower button projecting | |
|---|--|--|--------------------|---|--------------------|
| | | black bezel | Satin chrome bezel | black bezel | Satin chrome bezel |
|  | green button white cap, illuminated red button "I" | E2 1PDRL10423 | E2 1PDRL90423 | E2 1PDSL10423 | E2 1PDSL90423 |
|  | green button white cap, illuminated "O" red button "START" | E2 1PDRL1AAAD | E2 1PDRL9AAAD | E2 1PDSL1AAAD | E2 1PDSL9AAAD |
|  | green button white cap, illuminated "STOP" red button white button | E2 1PDRL1AAAP | E2 1PDRL9AAAP | E2 1PDSL1AAAP | E2 1PDSL9AAAP |
|  | white button white cap, illuminated black button "I" | E2 1PDRL10221 | E2 1PDRL90221 | E2 1PDSL10221 | E2 1PDSL90221 |
|  | white button white cap, illuminated "O" black button "START" | E2 1PDRL1AAA | E2 1PDRL9AAA | E2 1PDSL1AAA | E2 1PDSL9AAA |
|  | white button white cap, illuminated "STOP" black button ↑ | E2 1PDRL1AAAN | E2 1PDRL9AAAN | E2 1PDSL1AAAN | E2 1PDSL9AAAN |
|  | black button white cap, illuminated ↓ black button | E2 1PDRL1AAAB | E2 1PDRL9AAAB | E2 1PDSL1AAAB | E2 1PDSL9AAAB |





Other combinations on request.

Selection table for triple buttons



| Actuator colour and engraving | | upper button flush central button projecting lower button flush | |
|---|---|---|--------------------|
| | | black bezel | Satin chrome bezel |
|  | "I" green button "STOP" red button "II" | E2 1PTRS1AAAY | E2 1PTRS9AAAY |
|  | green button ← green button "STOP" red button → green button → | E2 1PTRS1AAAZ | E2 1PTRS9AAAZ |
|  | white button "STOP" red button ← black button ↑ | E2 1PTRS1AABD | E2 1PTRS9AABD |
|  | green button ↑ "STOP" red button ↓ green button | E2 1PTRS1AABA | E2 1PTRS9AABA |

Other combinations on request.

| Actuator colour and engraving | | upper button flush central button projecting lower button flush | |
|---|---|---|--------------------|
| | | black bezel | Satin chrome bezel |
|  | ↑ white button "STOP" red button ↓ black button ↑ | E2 1PTRS1AABE | E2 1PTRS9AABE |
|  | ↓ black button "STOP" red button ↓ black button "+" | E2 1PTRS1AABF | E2 1PTRS9AABF |
|  | + green button "STOP" red button - green button "+" | E2 1PTRS1AABB | E2 1PTRS9AABB |
|  | + white button "STOP" red button - white button -" | E2 1PTRS1AABC | E2 1PTRS9AABC |

Other combinations on request.

Complete units with double buttons



| Actuator colour and engraving | | Contacts | | | upper button flush central cap, flush lower button projecting black bezel |
|-------------------------------|--|----------|--------|--------|---|
| | | pos. 2 | pos. 3 | pos. 1 | |
| | "I" green button white cap, illuminated | | - | 1NO | E2 AC-DXBC0625 E2 1PDSL1AAAD + E2 1BAC11 + E2 CP01G2V1 + E2 CP10G2V1 |
| | "O" red button | 1NC ⊖ | | | |

Other combinations on request.

Complete units with triple buttons



| Actuator colour and engraving | | Contacts | | | upper button flush central button projecting lower button flush black bezel |
|-------------------------------|----------------------|----------|----------|--------|--|
| | | pos. 2 | pos. 3 | pos. 1 | |
| | "I" green button | | | 1NO | E2 AC-DXBC0801 E2 1PTRS1AAAY + E2 1BAC11 + E2 CP10G2V1 + E2 CP01G2V1 + E2 CP10G2V1 |
| | "STOP" red button | | 1NC ⊖ | | |
| | "II" green button | 1NO | | | |

Other combinations on request.



| Actuator colour and engraving | | Contacts | | | upper button flush central cap, flush lower button projecting black bezel |
|-------------------------------|--|----------|--------|--------|---|
| | | pos. 2 | pos. 3 | pos. 1 | |
| | "I" green button white cap, illuminated | | LED | 1NO | E2 AC-DXBC0602 E2 1PDSL1AAAD + E2 1BAC11 + E2 CP01G2V1 + E2 LP1A2V1 + E2 CP10G2V1 |
| | "O" red button | 1NC ⊖ | | | |

Other combinations on request.

→ For data regarding contact blocks and LED units, please see the respective chapters.

Protection cap

Packs of 10 pcs.

| | Article | Description |
|----------|--|---|
| | VE CA1C1 | Protection cap for double and triple projecting buttons |
| VE CA1D1 | Protection cap for double flush button | |

With the protection cap it is not possible to apply the shaped ring.

Shaped ring

Packs of 50 pcs.

| | Article | Description |
|--|------------|--|
| | VE GP12L1A | Shaped ring for double and triple button E2 ●PD●●●●●●●● E2 ●PT●●●●●●●● |

With the shaped ring it is not possible to apply the protection cap.

Accessories

→ More ACCESSORIES on page 161

Dimensional drawings

All values in the drawings are in mm

Flush double button

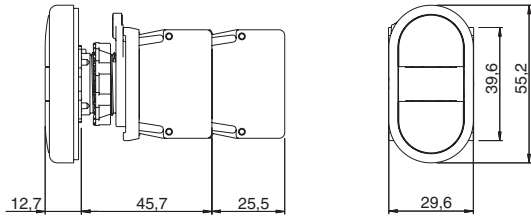

Projecting double button

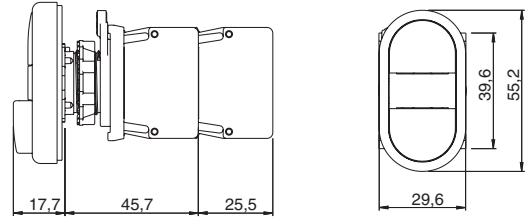

Triple button

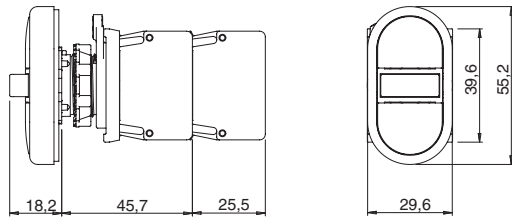

Minimum distances for installation

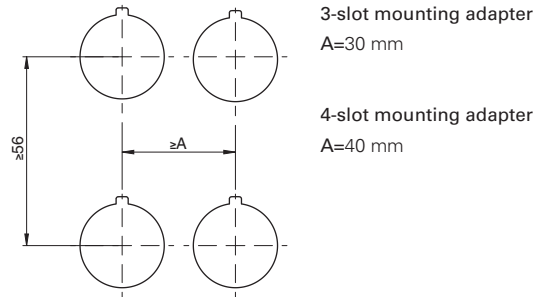

→ The 2D and 3D files are available at www.pizzato.com

Maximum number of contact blocks

3-slot mounting adapter

4-slot mounting adapter

Double buttons E2 •PD••••••••

Triple buttons E2 •PT••••••••

Double buttons E2 •PD•Q••••••

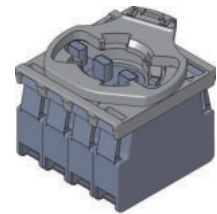
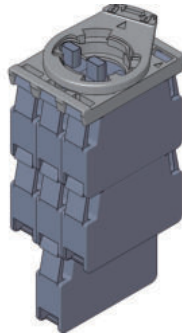
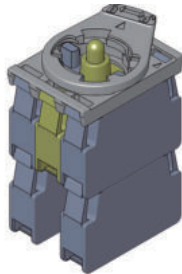

maximum number:
4 contact blocks
2 levels

maximum number:
7 contact blocks
3 levels

maximum number:
4 contact blocks
1 level

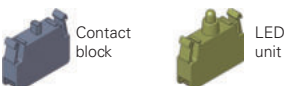
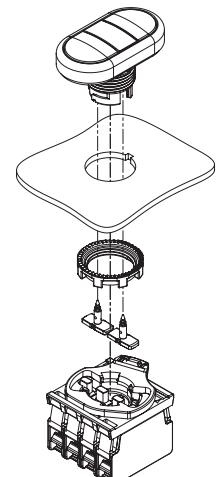
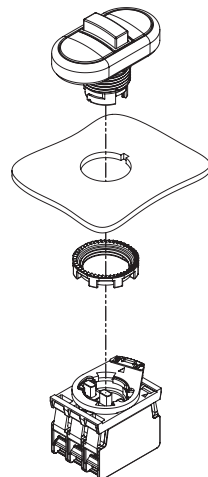

The actuators, with the specific button for 4-slot base, can be mounted only after fixing the button.

Selection diagram

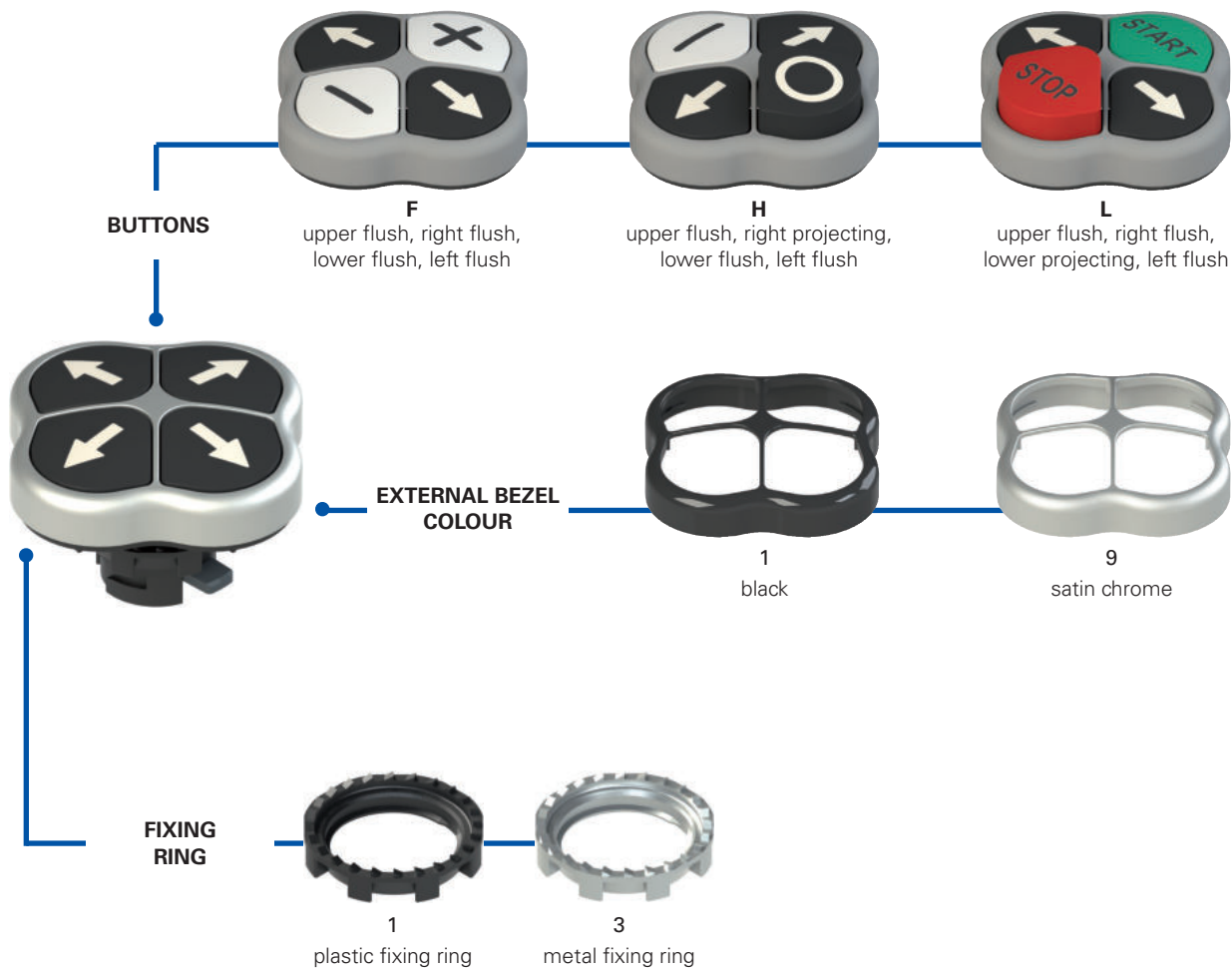

Code structure

Attention! The feasibility of a code number does not mean the effective availability of a product. Please contact our sales office.

E2 1PQFA1QAAA

Fixing ring and shaped ring

| | |
|---|-------------------------------------|
| 1 | plastic fixing ring (standard) |
| 2 | plastic fixing ring and shaped ring |
| 3 | metal fixing ring |
| 4 | metal fixing ring and shaped ring |

Buttons

| | |
|----------|--|
| F | upper flush, right flush, lower flush, left flush |
| H | upper flush, right projecting, lower flush, left flush |
| L | upper flush, right flush, lower projecting, left flush |

Other combinations on request.

Bezel colour

| | |
|----------|-------------------------|
| 1 | black (standard) |
| 9 | satin chrome (standard) |

Colours and symbols

| | upper button | | right button | | lower button | | left button | |
|-------------|--------------|--------|--------------|--------|--------------|--------|-------------|--------|
| | colour | symbol | colour | symbol | colour | symbol | colour | symbol |
| QAAA | black | ↑ | black | → | black | ↓ | black | ← |
| QAAB | green | START | black | → | red | STOP | black | ← |
| QAAC | white | START | black | → | black | STOP | black | ← |
| QAAD | green | | black | → | red | O | black | ← |
| QAAE | white | | black | → | black | O | black | ← |
| QAAF | white | + | black | → | white | - | black | ← |
| QAAH | black | ↑ | red | STOP | black | ↓ | green | START |
| QAAJ | black | ↑ | black | STOP | black | ↓ | white | START |
| QAAK | black | ↑ | red | O | black | ↓ | green | |
| QAAL | black | ↑ | black | O | black | ↓ | white | |
| QAAM | black | ↑ | white | - | black | ↓ | white | + |
| QAAN | black | ↑ | white | ☹ | black | ↓ | white | 🐎 |

Other combinations on request.



Technical data

General data

| | |
|---------------------------------------|----------------------------|
| Protection degree: | IP67 acc. to EN 60529 |
| Ambient temperature: | -25°C ... +80°C |
| Safety parameter B _{10D} : | 2,000,000 |
| Mechanical endurance: | 1 million operating cycles |
| Max. actuation frequency: | 3600 operating cycles/hour |
| Actuating force at limit of travel: | 6.5 N (without contacts) |
| Maximum travel: | 5 mm |
| Tightening torque of the fixing ring: | 2 ... 2.5 Nm |
| Utilization requirements: | see page 169 |

In compliance with standards:

IEC 60947-1, IEC 60947-5-1, IEC 60204-1, EN 60947-1, EN 60947-5-1, EN 60204-1, EN IEC 63000, UL 508, CSA C22.2 No. 14.

⚠ Installation for safety applications:

Use only contact blocks marked with the symbol ⊖. The safety circuit must always be connected to **NC contacts** (normally closed contacts: .1-2).

Compliance with the requirements of:

Low Voltage Directive 2014/35/EU,
EMC Directive 2014/30/EU,
RoHS Directive 2011/65/EU.

Positive contact opening in conformity with standards:

IEC 60947-5-1, EN 60947-5-1.

Features approved by UL

For Use on a Flat Surface of a Type 1, 4X, 12 and 13
Tightening torque 2.0 Nm

Main features

- Protection degree IP67
- Version with projecting buttons
- Customisation with symbols available

Quality marks:



IMQ approval: CA02.04805
UL approval: E131787
EAC approval: RU C-IT.YT03.B.00035/19

General data

Button profile



In order to be used in different types of application the EROUND line quadruple buttons are now available in two shapes: projecting and flush. The possible choice of shapes, colours and symbols allows various code combinations for buttons.

Shaped ring

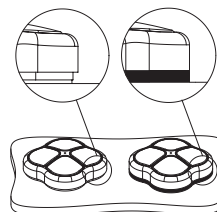

The shaped ring can be used when no label holder or other devices are applied; it prevents dirt and other residues from settling between the button and the panel or housing. This turns out to be particularly useful in the sectors where high standards of cleanness and hygiene are required.

Protection degree IP67

IP67 These devices are designed to be used under the toughest environmental conditions, and they pass the IP67 immersion test acc. to EN 60529. They can therefore be used in all environments where the maximum degree of protection is required for the housing.

Customisable

In order to suit the various requests and needs of the customers, Pizzato Elettrica offers the possibility to customize the quadruple buttons with indelible laser inscriptions and symbols.

Metal fixing ring



The fixing ring in metal is particularly suitable for those applications which require tighter fitting of the panel-mounted device, such as for example in metal panels having holes without reference notches.



Selection table for quadruple buttons



| Actuator colour and engraving (starting from the top and clockwise) | upper button flush right button flush lower button flush left button flush | | upper button flush right button projecting lower button flush left button flush | | upper button flush right button projecting lower button projecting left button flush | |
|--|---|--------------------|--|--------------------|---|--------------------|
| | black bezel | Satin chrome bezel | black bezel | Satin chrome bezel | black bezel | Satin chrome bezel |
| <ul style="list-style-type: none"> black button "↑" black button "→" black button "↓" black button "←" | E2 1PQFA1QAAA | E2 1PQFA9QAAA | - | - | - | - |
| <ul style="list-style-type: none"> black button "START" green button "→" black button "STOP" red button "←" | E2 1PQFA1QAAAB | E2 1PQFA9QAAAB | - | - | E2 1PQLA1QAAAB | E2 1PQLA9QAAAB |
| <ul style="list-style-type: none"> black button "START" white button "→" black button "STOP" black button "←" | E2 1PQFA1QAAAC | E2 1PQFA9QAAAC | - | - | E2 1PQLA1QAAAC | E2 1PQLA9QAAAC |
| <ul style="list-style-type: none"> green button "↑" black button "→" red button "↓" black button "←" | E2 1PQFA1QAAAD | E2 1PQFA9QAAAD | - | - | E2 1PQLA1QAAAD | E2 1PQLA9QAAAD |
| <ul style="list-style-type: none"> white button "↑" black button "→" black button "↓" black button "←" | E2 1PQFA1QAAE | E2 1PQFA9QAAE | - | - | E2 1PQLA1QAAE | E2 1PQLA9QAAE |
| <ul style="list-style-type: none"> white button "↑" black button "→" white button "↓" black button "←" | E2 1PQFA1QAAF | E2 1PQFA9QAAF | - | - | - | - |
| <ul style="list-style-type: none"> black button "START" red button "→" black button "STOP" green button "↓" | E2 1PQFA1QAAH | E2 1PQFA9QAAH | E2 1PQHA1QAAH | E2 1PQHA9QAAH | - | - |
| <ul style="list-style-type: none"> black button "STOP" black button "→" black button "START" white button "↓" | E2 1PQFA1QAAJ | E2 1PQFA9QAAJ | E2 1PQHA1QAAJ | E2 1PQHA9QAAJ | - | - |
| <ul style="list-style-type: none"> black button "↑" red button "→" black button "↓" green button "←" | E2 1PQFA1QAAK | E2 1PQFA9QAAK | E2 1PQHA1QAAK | E2 1PQHA9QAAK | - | - |
| <ul style="list-style-type: none"> black button "↑" black button "→" black button "↓" white button "←" | E2 1PQFA1QAAAL | E2 1PQFA9QAAAL | E2 1PQHA1QAAAL | E2 1PQHA9QAAAL | - | - |
| <ul style="list-style-type: none"> black button "↑" white button "→" black button "↓" white button "←" | E2 1PQFA1QAAAM | E2 1PQFA9QAAAM | - | - | - | - |



Other combinations on request.

Complete units



| Actuator colour and engraving (starting from the top and clockwise) | | Contacts | | | | upper button flush right button flush lower button flush left button flush | Satin chrome bezel |
|---|--------------------|----------|--------|--------|--------|---|--------------------|
| | | pos. 3 | pos. 2 | pos. 4 | pos. 1 | | |
|  | *↑ black button | | | 1NO | | E2 AC-DXBC2000 E2 1PQFA9QAAA + E2 1BAC21 + E2 CP10G2V1 + E2 CP10G2V1 + E2 CP10G2V1 + E2 CP10G2V1 | |
| | *→ black button | | | | 1NO | | |
| | *↓ black button | | 1NO | | | | |
| | *← black button | | | | | | |
| | *↶ black button | 1NO | | | | | |

Other combinations on request.

| Actuator colour and engraving (starting from the top and clockwise) | | Contacts | | | | upper button flush right button projecting lower button flush left button flush | Satin chrome bezel |
|---|------------------------|----------|--------|--------|--|---|--------------------|
| | | pos. 3 | pos. 2 | pos. 4 | pos. 1 | | |
|  | *↑ black button | | | 1NO | | E2 AC-DXBC2001 E2 1POHA9QAAH + E2 1BAC21 + E2 CP10G2V1 + E2 CP10G2V1 + E2 CP10G2V1 + E2 CP01G2V1 | |
| | *STOP red button | | | | 1NC  | | |
| | *↓ black button | | 1NO | | | | |
| | *START green button | 1NO | | | | | |
| | | | | | | | |

Other combinations on request.

Maximum number of contact blocks

4-slot mounting adapter

Quadruple buttons E2 •PQ••••••••

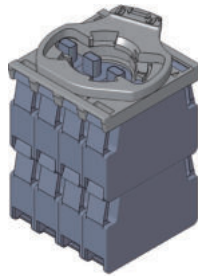

maximum number:
8 contact blocks
2 levels

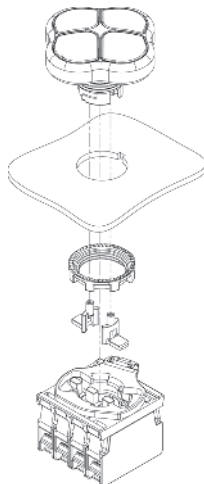

The assembly of the 2 lateral actuators, supplied with the quadruple button, must be done after the fixing of the button.



Contact block

→ The 2D and 3D files are available at www.pizzato.com

Mounting adapter Packs of 10 pcs.

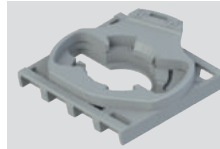

| Article | Description |
|-----------|---|
| E2 1BAC21 | 4-slot mounting adapter for E2 CP•••••• contact block |

Shaped ring Packs of 10 pcs.



| Article | Description |
|------------|---|
| VE GP12M1A | Shaped ring for quadruple button E2 •PQ•••••••• |

Dimensional drawings All values in the drawings are in mm

Quadruple button

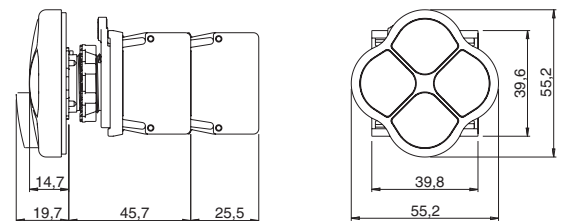

Minimum distances for installation

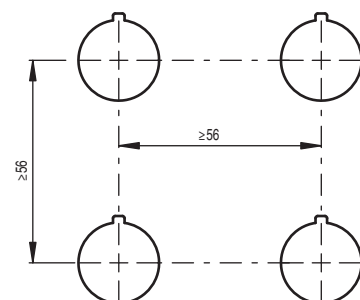

Selection diagram

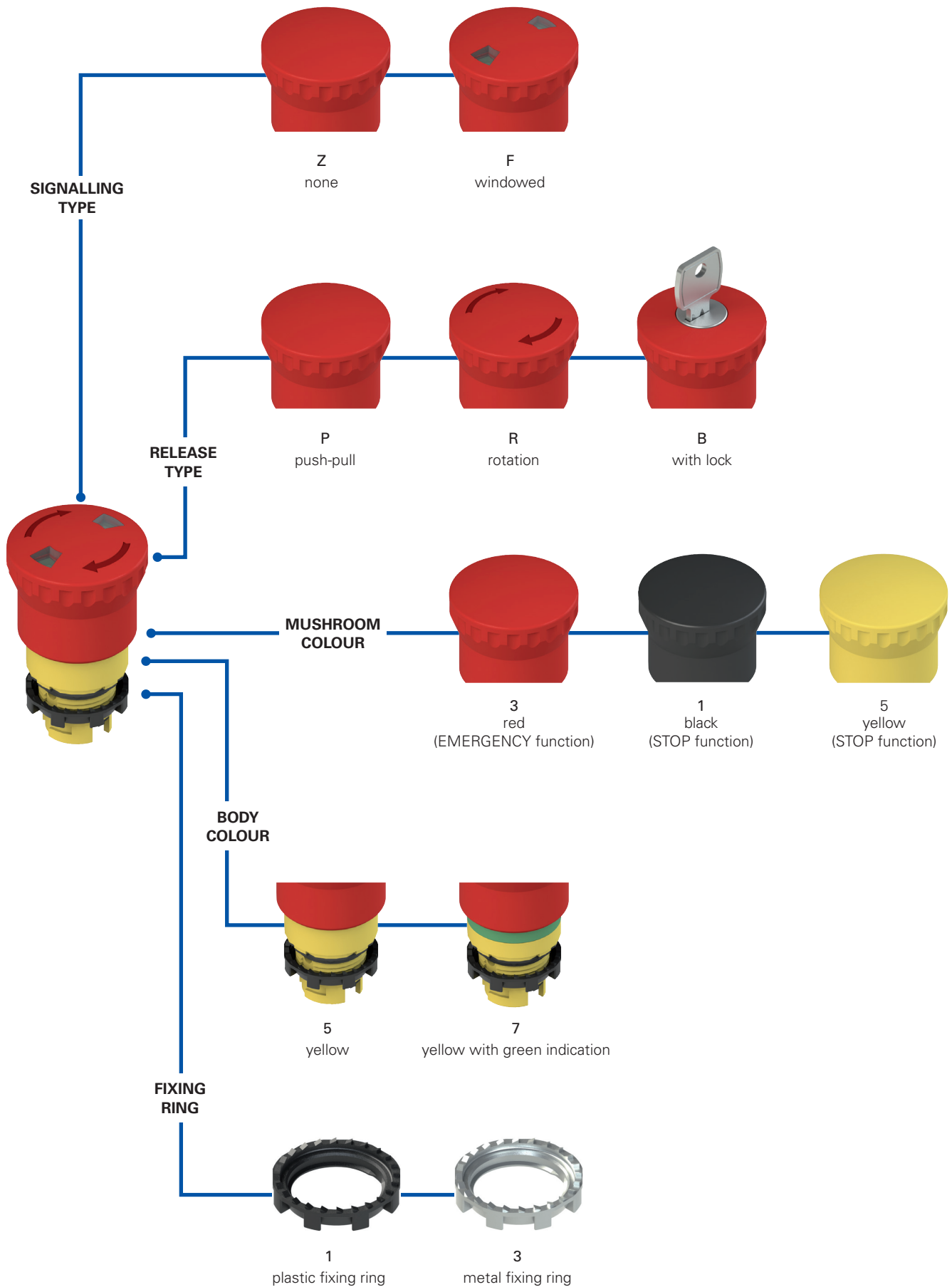

Code structure **Attention!** The feasibility of a code number does not mean the effective availability of a product. Please contact our sales office.

article
options
E2 1PERZ4531-T6

| Fixing ring and shaped ring | |
|-----------------------------|-------------------------------------|
| 1 | plastic fixing ring (standard) |
| 2 | plastic fixing ring and shaped ring |
| 3 | metal fixing ring |
| 4 | metal fixing ring and shaped ring |

| Release type | |
|--------------|--|
| P | push-pull |
| R | rotary release |
| B | key release with key 333 (standard) ⁽¹⁾ |
| C | key release with key 335 ⁽¹⁾ |
| ... | ... |
| M | key release with key 455 ⁽¹⁾ |

Other key codes on request.
⁽¹⁾ Not available with windowed signalling

| Signalling type | |
|-----------------|----------|
| Z | none |
| F | windowed |

| Ambient temperature | |
|---------------------|----------------------------|
| | -25°C ... +80°C (standard) |
| T6 | -40°C ... +80°C |

| Actuator type | |
|---------------|-----------------|
| 1 | for 3-slot base |
| 4 | for 4-slot base |

| Mushroom button colour | |
|------------------------|----------------------------|
| 1 | black ⁽¹⁾ |
| 3 | red (standard) |
| 5 | yellow ^{(1), (2)} |

⁽¹⁾ Not available with windowed signalling
⁽²⁾ Available with a rotary release or push-pull

| Body colour | |
|-------------|------------------------------|
| 5 | yellow (standard) |
| 7 | yellow with green indication |

| Mushroom diameter | |
|-------------------|------------------|
| 4 | Ø 40 mm mushroom |

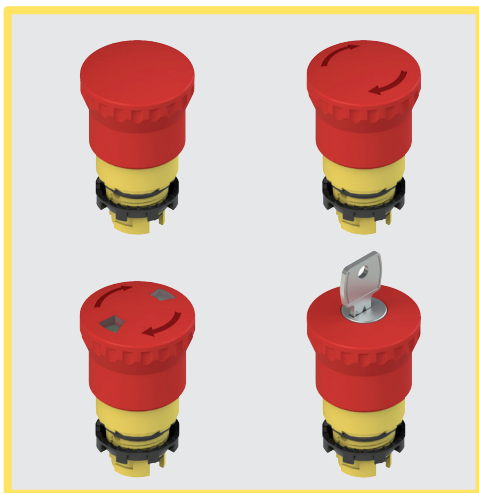

Main features

- Protection degrees IP67 and IP69K
- 3 different release modes
- Windowed version
- -40°C versions

Quality marks:



IMQ approval: CA02.04805
 UL approval: E131787
 EAC approval: RU C-IT.YT03.B.00035/19

Technical data

General data

| | |
|---------------------------------------|--|
| Protection degree: | IP67 acc. to EN 60529 IP69K acc. to ISO 20653 |
| Ambient temperature: | -25°C ... +80°C (standard) -40°C ... +80°C (T6 option) |
| Safety parameter B_{10D} : | 600,000 |
| Mechanical endurance: | 300,000 operating cycles |
| Max. actuation frequency: | 3600 operating cycles/hour |
| Actuation travel: | 4 mm (NO contact), 4 mm (NC contact) |
| Actuating force: | 30 N |
| Actuating force at limit of travel: | Push-pull 18.5 N (without contacts) Rotary release, 35 N (without contacts) |
| Maximum travel: | 9 mm |
| Tightening torque of the fixing ring: | 2,5 ... 3 Nm |
| Utilization requirements: | see page 169 |

In compliance with standards:

IEC 60947-1, IEC 60947-5-1, IEC 60947-5-5, IEC 60204-1, EN 60947-1, EN 60947-5-1, EN 60947-5-5, EN 60204-1, EN IEC 63000, EN ISO 13850, UL 508, CSA C22.2 No. 14.

⚠ Installation for safety applications:

Use only contact blocks marked with the symbol ⊕. The safety circuit must always be connected to **NC contacts** (normally closed contacts: .1-.2).

Compliance with the requirements of:

Machinery Directive 2006/42/EC, RoHS Directive 2011/65/EU.

Positive contact opening in conformity with standards:

IEC 60947-5-1, EN 60947-5-1.

Features approved by UL

For Use on a Flat Surface of a Type 1, 4X, 12 and 13
 Tightening torque 2.0 Nm

General data

Visual signalling

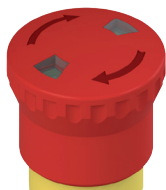

The versions of the emergency stop buttons with pull or rotary release can also visually signal the status with a mechanical indicator. The signalling windows change from green to red to signal the change of status of the button, namely from idle to actuated respectively.

Luminous disc

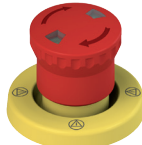

The luminous disc can also be used in all situations when it is necessary to highlight the emergency stop button on the machine compared to the other devices, or where there are more mushrooms and it is necessary to know which one has been pressed. Provided with high luminosity, it is available in the versions with continuous or blinking light. Protected with protection degree IP67, it can be customised with writings or symbols upon request. For details see page 157.

Self-monitored contact

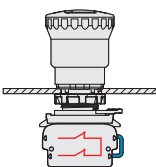

Specially designed for emergency mushroom buttons, the self-monitored contact makes it possible to reach a high level of self-control. Possible anomalies, such as the detachment from the emergency mushroom button, are immediately signalled by the opening of the safety circuit. This makes immediately evident failures that will be otherwise difficult to detect. Indeed, the detachment of a normal NC contact from the mushroom allows the machine to continue to function and makes the emergency stop unusable. For details see page 93.

Protection degrees IP67 and IP69K

IP69K
IP67

These devices are designed to be used under the toughest environmental conditions, and they pass the IP67 immersion test acc. to EN 60529. They can therefore be used in all environments where the maximum degree of protection is required for the housing. Due to their special design, these devices are suitable for use in equipment subjected to cleaning with high pressure hot water jets. These devices meet the IP69K test requirements according to ISO 20653 (water jets with 100 bar and 80°C).

Shaped ring

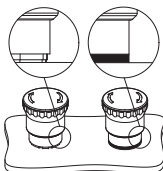

The shaped ring can be used when no label holder or other devices are applied; it prevents dirt and other residues from settling between the button and the panel or housing. This turns out to be particularly useful in sectors where high standards of cleanness and hygiene are required.





Extended temperature range

-40°C

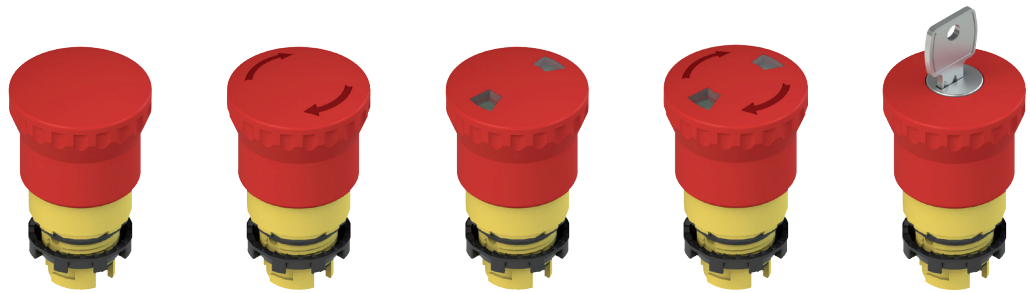
These devices are also available in a special version suitable for an ambient operating temperature range from -40°C up to +80°C. They can therefore be used for applications in cold stores, sterilisers and other equipment with low temperature environments. The special materials used to produce these versions retain their characteristics even under these conditions, thereby expanding the installation possibilities.

Selection table for emergency stop buttons





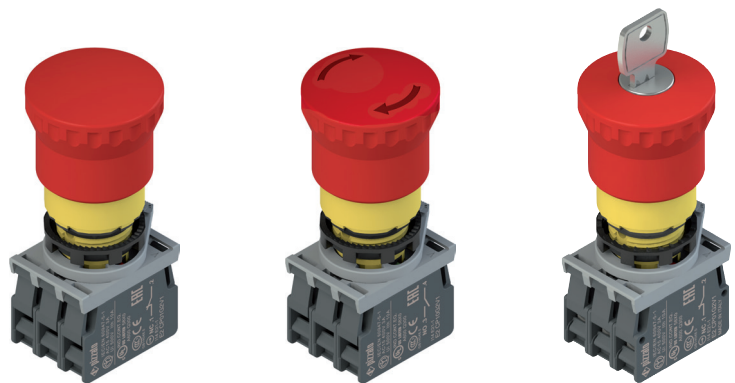

| Body and actuator colour | | Push-pull | Rotary release | Windowed push-pull | Windowed rotary release | Key release Key coding 333 |
|---|--|--------------|----------------|--------------------|-------------------------|-------------------------------|
|  | | E2 1PEPZ4531 | E2 1PERZ4531 | E2 1PEPF4531 | E2 1PERF4531 | E2 1PEBZ4531 |
|  | | E2 1PEPZ4731 | E2 1PERZ4731 | E2 1PEPF4731 | E2 1PERF4731 | E2 1PEBZ4731 |
|  | | E2 1PEPZ4511 | E2 1PERZ4511 | - | - | E2 1PEBZ4511 |
|  | | E2 1PEPZ4551 | E2 1PERZ4551 | - | - | - |

Attention! For safety applications, only use red mushrooms, black and yellow mushrooms can only be used for stop functions.

Complete units with emergency stop buttons



| Body and actuator colour | | Push-pull | Rotary release | Windowed push-pull | Windowed rotary release | Key release Key coding 333 |
|---|--|--|--|--|-------------------------|-------------------------------|
|  | | E2 AC-DXBC1005 E2 1PEPZ4531 + E2 1BAC11 + E2 CP01G2V1 | E2 AC-DXBC1006 E2 1PERZ4531 + E2 1BAC11 + E2 CP01G2V1 | E2 AC-DXBC1007 E2 1PEBZ4531 + E2 1BAC11 + E2 CP01G2V1 | | |
|  | | E2 AC-DXBC1022 E2 1PEPZ4531 + E2 1BAC11 + E2 CP01S2V1 | E2 AC-DXBC1023 E2 1PERZ4531 + E2 1BAC11 + E2 CP01S2V1 | E2 AC-DXBC1024 E2 1PEBZ4531 + E2 1BAC11 + E2 CP01S2V1 | | |
|  | | E2 AC-DXBC1010 E2 1PEPZ4531 + E2 1BAC11 + E2 CP01G2V1 + E2 CP01G2V1 | E2 AC-DXBC1002 E2 1PERZ4531 + E2 1BAC11 + E2 CP01G2V1 + E2 CP01G2V1 | E2 AC-DXBC1011 E2 1PEBZ4531 + E2 1BAC11 + E2 CP01G2V1 + E2 CP01G2V1 | | |
|  | | E2 AC-DXBC1012 E2 1PEPZ4531 + E2 1BAC11 + E2 CP01G2V1 + E2 CP01G2V1 + E2 CP10G2V1 | E2 AC-DXBC1000 E2 1PERZ4531 + E2 1BAC11 + E2 CP01G2V1 + E2 CP01G2V1 + E2 CP10G2V1 | E2 AC-DXBC1013 E2 1PEBZ4531 + E2 1BAC11 + E2 CP01G2V1 + E2 CP01G2V1 + E2 CP10G2V1 | | |

Other combinations on request.
 → For contact block features see page 87.

Locking keys

| Article | Description |
|---|--|
| VE KE1A00-PY333 | Locking key |
|  | Order only if further keys besides the supplied one are needed. Key with key coding 333. Other codes on request. |

Dimensional drawings

All values in the drawings are in mm

Emergency stop button

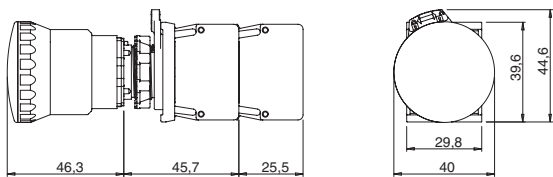

Emergency stop button with key release

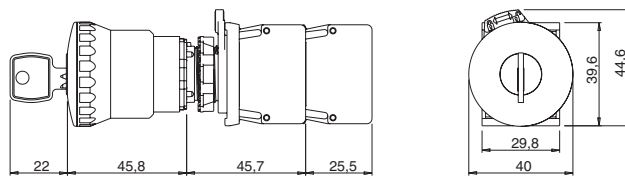

→ The 2D and 3D files are available at www.pizzato.com

Maximum number of contact blocks

3-slot mounting adapter

Emergency stop buttons E2 •PE•••••1

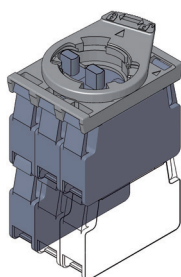

maximum number:
4 contact blocks
2 levels

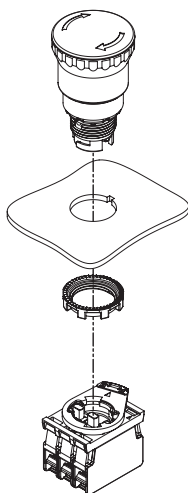

4-slot mounting adapter

Emergency stop buttons E2 •PE•••••4

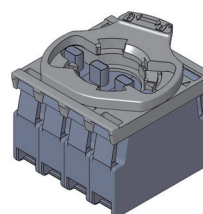

maximum number:
4 contact blocks
1 level

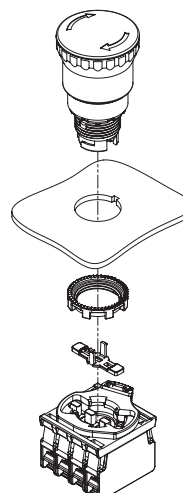

The mounting of the actuator for 4-slot base must be carried out after fixing the button.



Contact block



Alternative position contact block

Actuator for 4-slot base Packs of 10 pcs. **Minimum distances for installation**

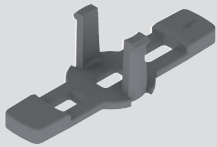
| | Article | Description |
|---|-----------|---|
|  | VE AS1218 | Closed long actuator for 4-slot mounting adapter. It must be installed after fixing the button to the wall. For E2 •PE•••••4 buttons. |

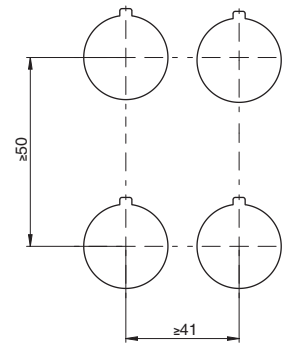











Accessories

→ More ACCESSORIES on page 161

Labels with shaped hole Packs of 5 pcs.

Suitable for devices E2 •PE•••••.
 In compliance with EN ISO 13850.
 Can be turned in 90° steps.
 Inscriptions in other languages available on request.

It does not alter the IP67 / IP69K protection degree of the associated device.

| | | |
|---|--------------|--|
|  | VE TF32A5700 | |
| | VE TF32D5700 | |
|  | VE TF32A5113 | |
| | VE TF32D5113 | |
|  | VE TF32A5101 | |
| | VE TF32D5101 | |
|  | VE TF32A5102 | |
| | VE TF32D5102 | |
|  | VE TF32A5109 | |
| | VE TF32D5109 | |
|  | VE TF32A5120 | |
| | VE TF32D5120 | |
|  | VE TF32G5700 | |
|  | VE TF32G5121 | |
|  | VE TF32G5103 | |
|  | VE TF32G5110 | |

Luminous disc

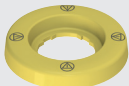
| | |
|---|---|
|  | Yellow luminous disc, Ø 60 mm. Data at page 157. |
|---|---|

Selection diagram

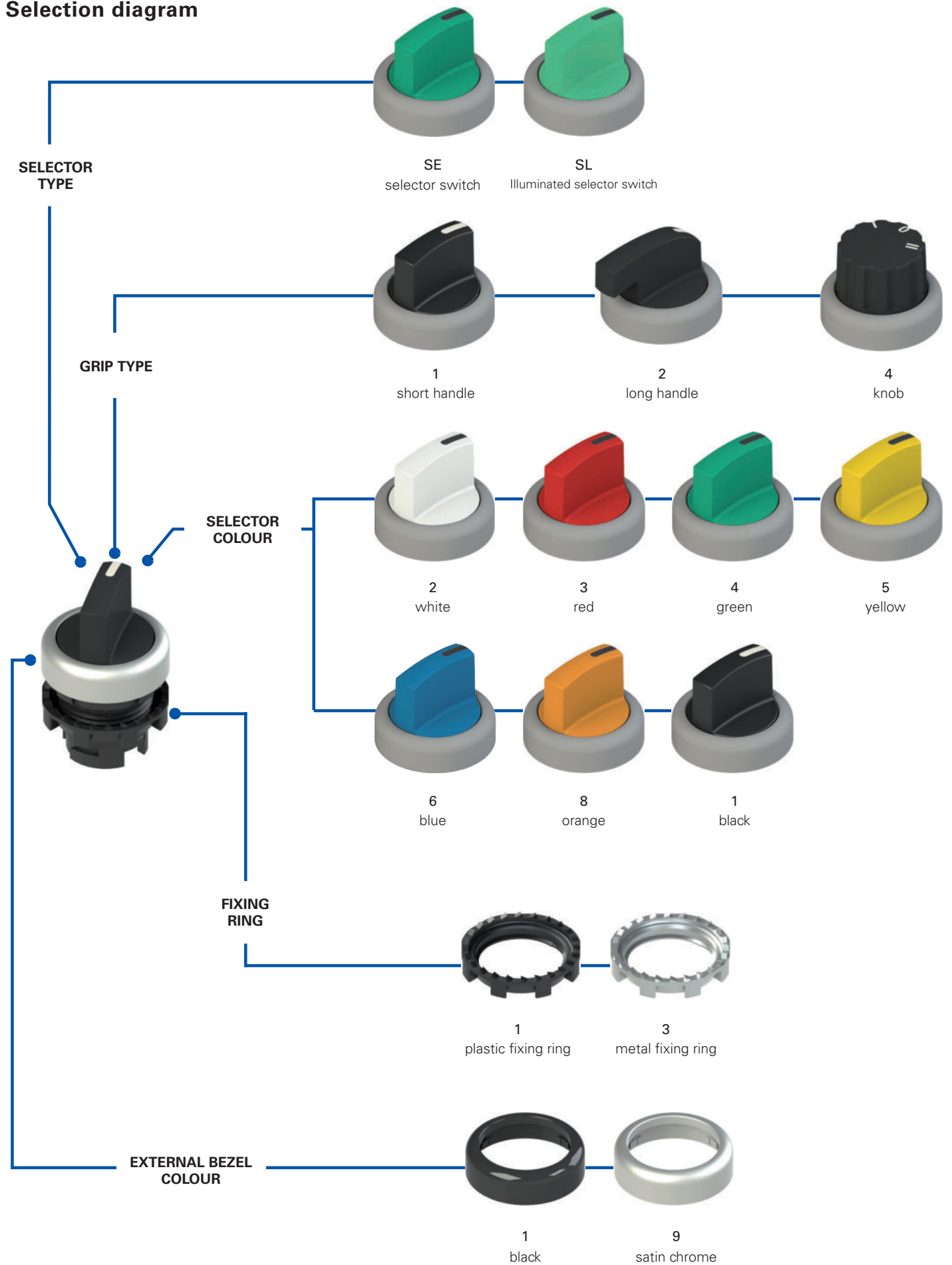

Selector switch code structure

Attention! The feasibility of a code number does not mean the effective availability of a product. Please contact our sales office.

article options
E2 1SE13ACE11AB-T6











Fixing ring and shaped ring



| | |
|---|-------------------------------------|
| 1 | plastic fixing ring (standard) |
| 2 | plastic fixing ring and shaped ring |
| 3 | metal fixing ring |
| 4 | metal fixing ring and shaped ring |

Grip type

| | |
|---|--------------|
| 1 | short handle |
| 2 | long handle |
| 4 | knob |

Positions

| | | | | |
|-----|---|-----|---|---|
| 2AV |  | 2AC |  | 3GC  4-position selector switches see p. 64 |
| 2EV |  | 2EC |  | |
| 2FV |  | 3AC |  | |
| 2FC |  | 3EC |  | |
| 2BC |  | 3FC |  | |

Legend:  Maintained  Spring-return

Cams and actuators

| | |
|---|--|
| A | cam for 2-position selector switch for 3-slot base |
| E | cam for 3-position selector switch for 3-slot base |
| Q | cam for 2-position selector switch for 4-slot base |
| R | cam for 3-position selector switch for 4-slot base |



Selector colour

| | |
|---|--------|
| 1 | black |
| 2 | white |
| 3 | red |
| 4 | green |
| 5 | yellow |
| 6 | blue |
| 8 | orange |

Ambient temperature

| | |
|----|----------------------------|
| | -25°C ... +80°C (standard) |
| T6 | -40°C ... +80°C |

Marking type

| | | |
|----|---|--|
| AB |  | indication notch (standard) |
| AC |  | only for knobs, positions 2AC, 2EC |
| AD |  | only for knobs, positions 3AC, 3EC, 3FC, 3GC |

Other combinations on request.

Bezel colour

| | |
|---|-------------------------|
| 1 | black (standard) |
| 9 | satın chrome (standard) |

Illuminated selector switch code structure

Attention! The feasibility of a code number does not mean the effective availability of a product. Please contact our sales office.

article options
E2 1SL13ACH21AB-T6











Fixing ring and shaped ring



| | |
|---|-------------------------------------|
| 1 | plastic fixing ring (standard) |
| 2 | plastic fixing ring and shaped ring |
| 3 | metal fixing ring |
| 4 | metal fixing ring and shaped ring |

Grip type

| | |
|---|--------------|
| 1 | short handle |
| 2 | long handle |
| 4 | knob |

Positions

| | | | | |
|-----|---|-----|---|---|
| 2AV |  | 2AC |  | 3GC  4-position selector switches see p. 64 |
| 2EV |  | 2EC |  | |
| 2FV |  | 3AC |  | |
| 2FC |  | 3EC |  | |
| 2BC |  | 3FC |  | |

Legend:  Maintained  Spring-return

Cams and actuators

| | |
|---|------------------------------------|
| D | Cam for 2-position selector switch |
| H | Cam for 3-position selector switch |



Selector colour

| | |
|---|--------|
| 2 | white |
| 3 | red |
| 4 | green |
| 5 | yellow |
| 6 | blue |
| 8 | orange |

Ambient temperature

| | |
|----|----------------------------|
| | -25°C ... +80°C (standard) |
| T6 | -40°C ... +80°C |

Marking type

| | | |
|----|---|--|
| AB |  | indication notch (standard) |
| AC |  | only for knobs, positions 2AC, 2EC |
| AD |  | only for knobs, positions 3AC, 3EC, 3FC, 3GC |

Other combinations on request.

Bezel colour

| | |
|---|-------------------------|
| 1 | black (standard) |
| 9 | satın chrome (standard) |



Main features

- Protection degrees IP67 and IP69K
- 3 different shapes
- Standard or illuminated version
- Maintained or spring-return version

Quality marks:



IMQ approval: CA02.04805
 UL approval: E131787
 EAC approval: RU C-IT.YT03.B.00035/19

Technical data

General data

| | |
|---------------------------------------|--|
| Protection degree: | IP67 acc. to EN 60529 IP69K acc. to ISO 20653 |
| Ambient temperature: | -25°C ... +80°C (standard) -40°C ... +80°C (T6 option) |
| Safety parameter B_{10D} : | 2,000,000 |
| Mechanical endurance: | 1 million operating cycles |
| Max. actuation frequency: | 3600 operating cycles/hour |
| Actuating force at limit of travel: | 0.07 Nm (without contacts) |
| Maximum travel: | 60° (2 stable positions) 40° (2 momentary positions) ±60° (3 stable positions) ±40° (3 momentary positions) |
| Tightening torque of the fixing ring: | 2 ... 2.5 Nm |
| Utilization requirements: | see page 169 |

In compliance with standards:

IEC 60947-1, IEC 60947-5-1, IEC 60204-1, EN 60947-1, EN 60947-5-1, EN 60204-1, EN IEC 63000, UL 508, CSA C22.2 No. 14.

⚠ Installation for safety applications:

Use only contact blocks marked with the symbol ⊕. The safety circuit must always be connected to **NC contacts** (normally closed contacts: .1-2).

Compliance with the requirements of:

Low Voltage Directive 2014/35/EU,
 EMC Directive 2014/30/EU,
 RoHS Directive 2011/65/EU.

Positive contact opening in conformity with standards:

IEC 60947-5-1, EN 60947-5-1.

Features approved by UL

For Use on a Flat Surface of a Type 1, 4X, 12 and 13
 Tightening torque 2.0 Nm

General data

Protection degrees IP67 and IP69K

IP69K
IP67

These devices are designed to be used under the toughest environmental conditions, and they pass the IP67 immersion test acc. to EN 60529. They can therefore be used in all environments where the maximum degree of protection is required for the housing. Due to their special design, these devices are suitable for use in equipment subjected to cleaning with high pressure hot water jets. These devices meet the IP69K test requirements according to ISO 20653 (water jets with 100 bar and 80°C).

Extended temperature range

-40°C

These devices are also available in a special version suitable for an ambient operating temperature range from -40°C up to +80°C. They can therefore be used for applications in cold stores, sterilisers and other equipment with low temperature environments. The special materials used to produce these versions retain their characteristics even under these conditions, thereby expanding the installation possibilities.

Shaped ring

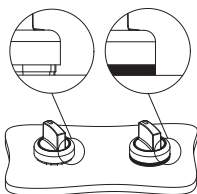

The shaped ring can be used when no label holder or other devices are applied; it prevents dirt and other residues from settling between the selector switch and the panel or housing. This turns out to be particularly useful in the sectors where high standards of cleanness and hygiene are required.

Actuators for selector switches

Three types of actuators are available, which activate the cursors of the contacts combined with the selector: a white actuator allowing the commutation of a single contact block, and a black or grey actuator allowing the simultaneous commutation of two contact blocks next to each other.

The white, black (3-slot base) and grey (4-slot base) actuators can be removed and replaced at any moment. This allows to configure at will the switching type executed by the selector on the contacts.

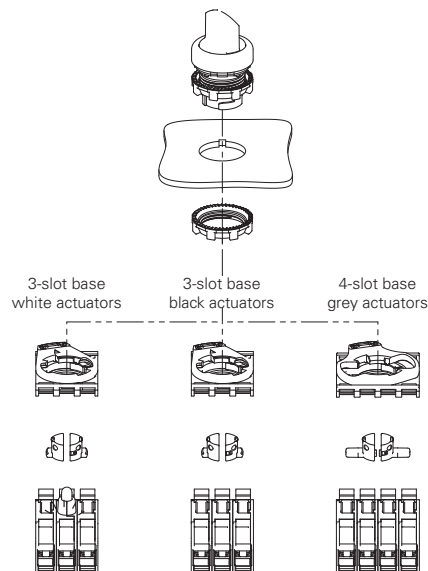

Selection table for selector switches



| Actuator colour and engraving | Two positions | short handle | | knob | | long handle | |
|-------------------------------|---------------|-----------------|--------------------|-----------------|--------------------|-----------------|--------------------|
| | | black bezel | Satin chrome bezel | black bezel | Satin chrome bezel | black bezel | Satin chrome bezel |
| black | ✓ | E2 1SE12AVA11AB | E2 1SE12AVA19AB | E2 1SE42AVA11AB | E2 1SE42AVA19AB | E2 1SE22AVA11AB | E2 1SE22AVA19AB |
| white | ✓ | E2 1SE12AVA21AB | E2 1SE12AVA29AB | E2 1SE42AVA21AB | E2 1SE42AVA29AB | E2 1SE22AVA21AB | E2 1SE22AVA29AB |
| red | ✓ | E2 1SE12AVA31AB | E2 1SE12AVA39AB | E2 1SE42AVA31AB | E2 1SE42AVA39AB | E2 1SE22AVA31AB | E2 1SE22AVA39AB |
| green | ✓ | E2 1SE12AVA41AB | E2 1SE12AVA49AB | E2 1SE42AVA41AB | E2 1SE42AVA49AB | E2 1SE22AVA41AB | E2 1SE22AVA49AB |
| yellow | ✓ | E2 1SE12AVA51AB | E2 1SE12AVA59AB | E2 1SE42AVA51AB | E2 1SE42AVA59AB | E2 1SE22AVA51AB | E2 1SE22AVA59AB |
| blue | ✓ | E2 1SE12AVA61AB | E2 1SE12AVA69AB | E2 1SE42AVA61AB | E2 1SE42AVA69AB | E2 1SE22AVA61AB | E2 1SE22AVA69AB |
| orange | ✓ | E2 1SE12AVA81AB | E2 1SE12AVA89AB | E2 1SE42AVA81AB | E2 1SE42AVA89AB | E2 1SE22AVA81AB | E2 1SE22AVA89AB |
| black | ✓ | E2 1SE12EVA11AB | E2 1SE12EVA19AB | E2 1SE42EVA11AB | E2 1SE42EVA19AB | E2 1SE22EVA11AB | E2 1SE22EVA19AB |
| white | ✓ | E2 1SE12EVA21AB | E2 1SE12EVA29AB | E2 1SE42EVA21AB | E2 1SE42EVA29AB | E2 1SE22EVA21AB | E2 1SE22EVA29AB |
| red | ✓ | E2 1SE12EVA31AB | E2 1SE12EVA39AB | E2 1SE42EVA31AB | E2 1SE42EVA39AB | E2 1SE22EVA31AB | E2 1SE22EVA39AB |
| green | ✓ | E2 1SE12EVA41AB | E2 1SE12EVA49AB | E2 1SE42EVA41AB | E2 1SE42EVA49AB | E2 1SE22EVA41AB | E2 1SE22EVA49AB |
| yellow | ✓ | E2 1SE12EVA51AB | E2 1SE12EVA59AB | E2 1SE42EVA51AB | E2 1SE42EVA59AB | E2 1SE22EVA51AB | E2 1SE22EVA59AB |
| blue | ✓ | E2 1SE12EVA61AB | E2 1SE12EVA69AB | E2 1SE42EVA61AB | E2 1SE42EVA69AB | E2 1SE22EVA61AB | E2 1SE22EVA69AB |
| orange | ✓ | E2 1SE12EVA81AB | E2 1SE12EVA89AB | E2 1SE42EVA81AB | E2 1SE42EVA89AB | E2 1SE22EVA81AB | E2 1SE22EVA89AB |
| black | ✓ | E2 1SE12ACA11AB | E2 1SE12ACA19AB | E2 1SE42ACA11AB | E2 1SE42ACA19AB | E2 1SE22ACA11AB | E2 1SE22ACA19AB |
| white | ✓ | E2 1SE12ACA21AB | E2 1SE12ACA29AB | E2 1SE42ACA21AB | E2 1SE42ACA29AB | E2 1SE22ACA21AB | E2 1SE22ACA29AB |
| red | ✓ | E2 1SE12ACA31AB | E2 1SE12ACA39AB | E2 1SE42ACA31AB | E2 1SE42ACA39AB | E2 1SE22ACA31AB | E2 1SE22ACA39AB |
| green | ✓ | E2 1SE12ACA41AB | E2 1SE12ACA49AB | E2 1SE42ACA41AB | E2 1SE42ACA49AB | E2 1SE22ACA41AB | E2 1SE22ACA49AB |
| yellow | ✓ | E2 1SE12ACA51AB | E2 1SE12ACA59AB | E2 1SE42ACA51AB | E2 1SE42ACA59AB | E2 1SE22ACA51AB | E2 1SE22ACA59AB |
| blue | ✓ | E2 1SE12ACA61AB | E2 1SE12ACA69AB | E2 1SE42ACA61AB | E2 1SE42ACA69AB | E2 1SE22ACA61AB | E2 1SE22ACA69AB |
| orange | ✓ | E2 1SE12ACA81AB | E2 1SE12ACA89AB | E2 1SE42ACA81AB | E2 1SE42ACA89AB | E2 1SE22ACA81AB | E2 1SE22ACA89AB |
| black | ✓ | E2 1SE12ECA11AB | E2 1SE12ECA19AB | E2 1SE42ECA11AB | E2 1SE42ECA19AB | E2 1SE22ECA11AB | E2 1SE22ECA19AB |
| white | ✓ | E2 1SE12ECA21AB | E2 1SE12ECA29AB | E2 1SE42ECA21AB | E2 1SE42ECA29AB | E2 1SE22ECA21AB | E2 1SE22ECA29AB |
| red | ✓ | E2 1SE12ECA31AB | E2 1SE12ECA39AB | E2 1SE42ECA31AB | E2 1SE42ECA39AB | E2 1SE22ECA31AB | E2 1SE22ECA39AB |
| green | ✓ | E2 1SE12ECA41AB | E2 1SE12ECA49AB | E2 1SE42ECA41AB | E2 1SE42ECA49AB | E2 1SE22ECA41AB | E2 1SE22ECA49AB |
| yellow | ✓ | E2 1SE12ECA51AB | E2 1SE12ECA59AB | E2 1SE42ECA51AB | E2 1SE42ECA59AB | E2 1SE22ECA51AB | E2 1SE22ECA59AB |
| blue | ✓ | E2 1SE12ECA61AB | E2 1SE12ECA69AB | E2 1SE42ECA61AB | E2 1SE42ECA69AB | E2 1SE22ECA61AB | E2 1SE22ECA69AB |
| orange | ✓ | E2 1SE12ECA81AB | E2 1SE12ECA89AB | E2 1SE42ECA81AB | E2 1SE42ECA89AB | E2 1SE22ECA81AB | E2 1SE22ECA89AB |

Legend: ✓ Maintained ▷ Spring-return

On request, knob selector switches can be customized with symbols and inscriptions.

3-slot mounting adapter

The non-illuminated 2-position selector switches activate the contact blocks as the figure shows.

Other combinations on request

4-slot mounting adapter

The non-illuminated 2-position selector switches activate the contact blocks as the figure shows.

The mounting of the actuators for 4-slot base must be carried out after fixing the selector.

Other combinations on request

Selection table for selector switches



| Actuator colour and engraving | Three positions | short handle | | knob | | long handle | |
|-------------------------------|-----------------|-----------------|--------------------|-----------------|--------------------|-----------------|--------------------|
| | | black bezel | Satin chrome bezel | black bezel | Satin chrome bezel | black bezel | Satin chrome bezel |
| ● black | ∨ | E2 1SE13ACE11AB | E2 1SE13ACE19AB | E2 1SE43ACE11AB | E2 1SE43ACE19AB | E2 1SE23ACE11AB | E2 1SE23ACE19AB |
| ○ white | ∨ | E2 1SE13ACE21AB | E2 1SE13ACE29AB | E2 1SE43ACE21AB | E2 1SE43ACE29AB | E2 1SE23ACE21AB | E2 1SE23ACE29AB |
| ● red | ∨ | E2 1SE13ACE31AB | E2 1SE13ACE39AB | E2 1SE43ACE31AB | E2 1SE43ACE39AB | E2 1SE23ACE31AB | E2 1SE23ACE39AB |
| ● green | ∨ | E2 1SE13ACE41AB | E2 1SE13ACE49AB | E2 1SE43ACE41AB | E2 1SE43ACE49AB | E2 1SE23ACE41AB | E2 1SE23ACE49AB |
| ● yellow | ∨ | E2 1SE13ACE51AB | E2 1SE13ACE59AB | E2 1SE43ACE51AB | E2 1SE43ACE59AB | E2 1SE23ACE51AB | E2 1SE23ACE59AB |
| ● blue | ∨ | E2 1SE13ACE61AB | E2 1SE13ACE69AB | E2 1SE43ACE61AB | E2 1SE43ACE69AB | E2 1SE23ACE61AB | E2 1SE23ACE69AB |
| ● orange | ∨ | E2 1SE13ACE81AB | E2 1SE13ACE89AB | E2 1SE43ACE81AB | E2 1SE43ACE89AB | E2 1SE23ACE81AB | E2 1SE23ACE89AB |
| ● black | ∨ | E2 1SE13ECE11AB | E2 1SE13ECE19AB | E2 1SE43ECE11AB | E2 1SE43ECE19AB | E2 1SE23ECE11AB | E2 1SE23ECE19AB |
| ○ white | ∨ | E2 1SE13ECE21AB | E2 1SE13ECE29AB | E2 1SE43ECE21AB | E2 1SE43ECE29AB | E2 1SE23ECE21AB | E2 1SE23ECE29AB |
| ● red | ∨ | E2 1SE13ECE31AB | E2 1SE13ECE39AB | E2 1SE43ECE31AB | E2 1SE43ECE39AB | E2 1SE23ECE31AB | E2 1SE23ECE39AB |
| ● green | ∨ | E2 1SE13ECE41AB | E2 1SE13ECE49AB | E2 1SE43ECE41AB | E2 1SE43ECE49AB | E2 1SE23ECE41AB | E2 1SE23ECE49AB |
| ● yellow | ∨ | E2 1SE13ECE51AB | E2 1SE13ECE59AB | E2 1SE43ECE51AB | E2 1SE43ECE59AB | E2 1SE23ECE51AB | E2 1SE23ECE59AB |
| ● blue | ∨ | E2 1SE13ECE61AB | E2 1SE13ECE69AB | E2 1SE43ECE61AB | E2 1SE43ECE69AB | E2 1SE23ECE61AB | E2 1SE23ECE69AB |
| ● orange | ∨ | E2 1SE13ECE81AB | E2 1SE13ECE89AB | E2 1SE43ECE81AB | E2 1SE43ECE89AB | E2 1SE23ECE81AB | E2 1SE23ECE89AB |
| ● black | ∨ | E2 1SE13FCE11AB | E2 1SE13FCE19AB | E2 1SE43FCE11AB | E2 1SE43FCE19AB | E2 1SE23FCE11AB | E2 1SE23FCE19AB |
| ○ white | ∨ | E2 1SE13FCE21AB | E2 1SE13FCE29AB | E2 1SE43FCE21AB | E2 1SE43FCE29AB | E2 1SE23FCE21AB | E2 1SE23FCE29AB |
| ● red | ∨ | E2 1SE13FCE31AB | E2 1SE13FCE39AB | E2 1SE43FCE31AB | E2 1SE43FCE39AB | E2 1SE23FCE31AB | E2 1SE23FCE39AB |
| ● green | ∨ | E2 1SE13FCE41AB | E2 1SE13FCE49AB | E2 1SE43FCE41AB | E2 1SE43FCE49AB | E2 1SE23FCE41AB | E2 1SE23FCE49AB |
| ● yellow | ∨ | E2 1SE13FCE51AB | E2 1SE13FCE59AB | E2 1SE43FCE51AB | E2 1SE43FCE59AB | E2 1SE23FCE51AB | E2 1SE23FCE59AB |
| ● blue | ∨ | E2 1SE13FCE61AB | E2 1SE13FCE69AB | E2 1SE43FCE61AB | E2 1SE43FCE69AB | E2 1SE23FCE61AB | E2 1SE23FCE69AB |
| ● orange | ∨ | E2 1SE13FCE81AB | E2 1SE13FCE89AB | E2 1SE43FCE81AB | E2 1SE43FCE89AB | E2 1SE23FCE81AB | E2 1SE23FCE89AB |
| ● black | ∨ | E2 1SE13GCE11AB | E2 1SE13GCE19AB | E2 1SE43GCE11AB | E2 1SE43GCE19AB | E2 1SE23GCE11AB | E2 1SE23GCE19AB |
| ○ white | ∨ | E2 1SE13GCE21AB | E2 1SE13GCE29AB | E2 1SE43GCE21AB | E2 1SE43GCE29AB | E2 1SE23GCE21AB | E2 1SE23GCE29AB |
| ● red | ∨ | E2 1SE13GCE31AB | E2 1SE13GCE39AB | E2 1SE43GCE31AB | E2 1SE43GCE39AB | E2 1SE23GCE31AB | E2 1SE23GCE39AB |
| ● green | ∨ | E2 1SE13GCE41AB | E2 1SE13GCE49AB | E2 1SE43GCE41AB | E2 1SE43GCE49AB | E2 1SE23GCE41AB | E2 1SE23GCE49AB |
| ● yellow | ∨ | E2 1SE13GCE51AB | E2 1SE13GCE59AB | E2 1SE43GCE51AB | E2 1SE43GCE59AB | E2 1SE23GCE51AB | E2 1SE23GCE59AB |
| ● blue | ∨ | E2 1SE13GCE61AB | E2 1SE13GCE69AB | E2 1SE43GCE61AB | E2 1SE43GCE69AB | E2 1SE23GCE61AB | E2 1SE23GCE69AB |
| ● orange | ∨ | E2 1SE13GCE81AB | E2 1SE13GCE89AB | E2 1SE43GCE81AB | E2 1SE43GCE89AB | E2 1SE23GCE81AB | E2 1SE23GCE89AB |

Legend ∨ Maintained ▷ Spring-return

On request, knob selector switches can be customized with symbols and inscriptions.

3-slot mounting adapter

The non-illuminated 3-position selector switches are supplied with black actuators that activate the contact blocks as the figure shows.

4-slot mounting adapter

The non-illuminated 3-position selector switches activate the contact blocks as the figure shows.

The mounting of the actuators for 4-slot base must be carried out after fixing the selector.

Other combinations on request.

Other combinations on request.

Selection table for illuminated selector switches



| Actuator colour and engraving | Two positions | short handle | | knob | | long handle | |
|-------------------------------|---------------|-----------------|--------------------|-----------------|--------------------|-----------------|--------------------|
| | | black bezel | Satin chrome bezel | black bezel | Satin chrome bezel | black bezel | Satin chrome bezel |
| white | | E2 1SL12AVD21AB | E2 1SL12AVD29AB | E2 1SL42AVD21AB | E2 1SL42AVD29AB | E2 1SL22AVD21AB | E2 1SL22AVD29AB |
| red | | E2 1SL12AVD31AB | E2 1SL12AVD39AB | E2 1SL42AVD31AB | E2 1SL42AVD39AB | E2 1SL22AVD31AB | E2 1SL22AVD39AB |
| green | | E2 1SL12AVD41AB | E2 1SL12AVD49AB | E2 1SL42AVD41AB | E2 1SL42AVD49AB | E2 1SL22AVD41AB | E2 1SL22AVD49AB |
| yellow | | E2 1SL12AVD51AB | E2 1SL12AVD59AB | E2 1SL42AVD51AB | E2 1SL42AVD59AB | E2 1SL22AVD51AB | E2 1SL22AVD59AB |
| blue | | E2 1SL12AVD61AB | E2 1SL12AVD69AB | E2 1SL42AVD61AB | E2 1SL42AVD69AB | E2 1SL22AVD61AB | E2 1SL22AVD69AB |
| orange | | E2 1SL12AVD81AB | E2 1SL12AVD89AB | E2 1SL42AVD81AB | E2 1SL42AVD89AB | E2 1SL22AVD81AB | E2 1SL22AVD89AB |
| white | | E2 1SL12EVD21AB | E2 1SL12EVD29AB | E2 1SL42EVD21AB | E2 1SL42EVD29AB | E2 1SL22EVD21AB | E2 1SL22EVD29AB |
| red | | E2 1SL12EVD31AB | E2 1SL12EVD39AB | E2 1SL42EVD31AB | E2 1SL42EVD39AB | E2 1SL22EVD31AB | E2 1SL22EVD39AB |
| green | | E2 1SL12EVD41AB | E2 1SL12EVD49AB | E2 1SL42EVD41AB | E2 1SL42EVD49AB | E2 1SL22EVD41AB | E2 1SL22EVD49AB |
| yellow | | E2 1SL12EVD51AB | E2 1SL12EVD59AB | E2 1SL42EVD51AB | E2 1SL42EVD59AB | E2 1SL22EVD51AB | E2 1SL22EVD59AB |
| blue | | E2 1SL12EVD61AB | E2 1SL12EVD69AB | E2 1SL42EVD61AB | E2 1SL42EVD69AB | E2 1SL22EVD61AB | E2 1SL22EVD69AB |
| orange | | E2 1SL12EVD81AB | E2 1SL12EVD89AB | E2 1SL42EVD81AB | E2 1SL42EVD89AB | E2 1SL22EVD81AB | E2 1SL22EVD89AB |
| white | | E2 1SL12ACD21AB | E2 1SL12ACD29AB | E2 1SL42ACD21AB | E2 1SL42ACD29AB | E2 1SL22ACD21AB | E2 1SL22ACD29AB |
| red | | E2 1SL12ACD31AB | E2 1SL12ACD39AB | E2 1SL42ACD31AB | E2 1SL42ACD39AB | E2 1SL22ACD31AB | E2 1SL22ACD39AB |
| green | | E2 1SL12ACD41AB | E2 1SL12ACD49AB | E2 1SL42ACD41AB | E2 1SL42ACD49AB | E2 1SL22ACD41AB | E2 1SL22ACD49AB |
| yellow | | E2 1SL12ACD51AB | E2 1SL12ACD59AB | E2 1SL42ACD51AB | E2 1SL42ACD59AB | E2 1SL22ACD51AB | E2 1SL22ACD59AB |
| blue | | E2 1SL12ACD61AB | E2 1SL12ACD69AB | E2 1SL42ACD61AB | E2 1SL42ACD69AB | E2 1SL22ACD61AB | E2 1SL22ACD69AB |
| orange | | E2 1SL12ACD81AB | E2 1SL12ACD89AB | E2 1SL42ACD81AB | E2 1SL42ACD89AB | E2 1SL22ACD81AB | E2 1SL22ACD89AB |
| white | | E2 1SL12ECD21AB | E2 1SL12ECD29AB | E2 1SL42ECD21AB | E2 1SL42ECD29AB | E2 1SL22ECD21AB | E2 1SL22ECD29AB |
| red | | E2 1SL12ECD31AB | E2 1SL12ECD39AB | E2 1SL42ECD31AB | E2 1SL42ECD39AB | E2 1SL22ECD31AB | E2 1SL22ECD39AB |
| green | | E2 1SL12ECD41AB | E2 1SL12ECD49AB | E2 1SL42ECD41AB | E2 1SL42ECD49AB | E2 1SL22ECD41AB | E2 1SL22ECD49AB |
| yellow | | E2 1SL12ECD51AB | E2 1SL12ECD59AB | E2 1SL42ECD51AB | E2 1SL42ECD59AB | E2 1SL22ECD51AB | E2 1SL22ECD59AB |
| blue | | E2 1SL12ECD61AB | E2 1SL12ECD69AB | E2 1SL42ECD61AB | E2 1SL42ECD69AB | E2 1SL22ECD61AB | E2 1SL22ECD69AB |
| orange | | E2 1SL12ECD81AB | E2 1SL12ECD89AB | E2 1SL42ECD81AB | E2 1SL42ECD89AB | E2 1SL22ECD81AB | E2 1SL22ECD89AB |

Legend: Maintained Spring-return

On request, knob selector switches can be customized with symbols and inscriptions.

3-slot mounting adapter

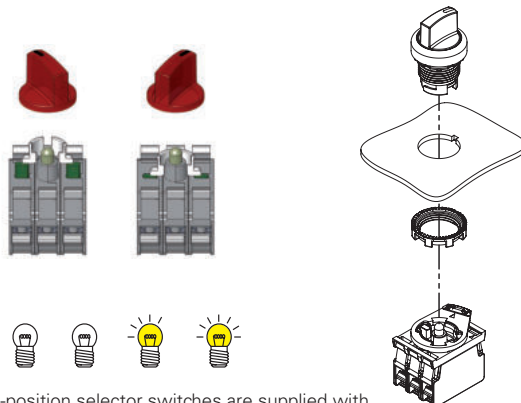

The illuminated 2-position selector switches are supplied with white actuators that activate the contact blocks as the figure shows.

Other combinations on request.

Selection table for illuminated selector switches



| Actuator colour and engraving | Three positions | short handle | | knob | | long handle | |
|-------------------------------|-----------------|-----------------|--------------------|-----------------|--------------------|-----------------|--------------------|
| | | black bezel | Satin chrome bezel | black bezel | Satin chrome bezel | black bezel | Satin chrome bezel |
| white | ↓ | E2 1SL13ACH21AB | E2 1SL13ACH29AB | E2 1SL43ACH21AB | E2 1SL43ACH29AB | E2 1SL23ACH21AB | E2 1SL23ACH29AB |
| red | ↓ | E2 1SL13ACH31AB | E2 1SL13ACH39AB | E2 1SL43ACH31AB | E2 1SL43ACH39AB | E2 1SL23ACH31AB | E2 1SL23ACH39AB |
| green | ↓ | E2 1SL13ACH41AB | E2 1SL13ACH49AB | E2 1SL43ACH41AB | E2 1SL43ACH49AB | E2 1SL23ACH41AB | E2 1SL23ACH49AB |
| yellow | ↓ | E2 1SL13ACH51AB | E2 1SL13ACH59AB | E2 1SL43ACH51AB | E2 1SL43ACH59AB | E2 1SL23ACH51AB | E2 1SL23ACH59AB |
| blue | ↓ | E2 1SL13ACH61AB | E2 1SL13ACH69AB | E2 1SL43ACH61AB | E2 1SL43ACH69AB | E2 1SL23ACH61AB | E2 1SL23ACH69AB |
| orange | ↓ | E2 1SL13ACH81AB | E2 1SL13ACH89AB | E2 1SL43ACH81AB | E2 1SL43ACH89AB | E2 1SL23ACH81AB | E2 1SL23ACH89AB |
| white | ↙ | E2 1SL13ECH21AB | E2 1SL13ECH29AB | E2 1SL43ECH21AB | E2 1SL43ECH29AB | E2 1SL23ECH21AB | E2 1SL23ECH29AB |
| red | ↙ | E2 1SL13ECH31AB | E2 1SL13ECH39AB | E2 1SL43ECH31AB | E2 1SL43ECH39AB | E2 1SL23ECH31AB | E2 1SL23ECH39AB |
| green | ↙ | E2 1SL13ECH41AB | E2 1SL13ECH49AB | E2 1SL43ECH41AB | E2 1SL43ECH49AB | E2 1SL23ECH41AB | E2 1SL23ECH49AB |
| yellow | ↙ | E2 1SL13ECH51AB | E2 1SL13ECH59AB | E2 1SL43ECH51AB | E2 1SL43ECH59AB | E2 1SL23ECH51AB | E2 1SL23ECH59AB |
| blue | ↙ | E2 1SL13ECH61AB | E2 1SL13ECH69AB | E2 1SL43ECH61AB | E2 1SL43ECH69AB | E2 1SL23ECH61AB | E2 1SL23ECH69AB |
| orange | ↙ | E2 1SL13ECH81AB | E2 1SL13ECH89AB | E2 1SL43ECH81AB | E2 1SL43ECH89AB | E2 1SL23ECH81AB | E2 1SL23ECH89AB |
| white | ↘ | E2 1SL13FCH21AB | E2 1SL13FCH29AB | E2 1SL43FCH21AB | E2 1SL43FCH29AB | E2 1SL23FCH21AB | E2 1SL23FCH29AB |
| red | ↘ | E2 1SL13FCH31AB | E2 1SL13FCH39AB | E2 1SL43FCH31AB | E2 1SL43FCH39AB | E2 1SL23FCH31AB | E2 1SL23FCH39AB |
| green | ↘ | E2 1SL13FCH41AB | E2 1SL13FCH49AB | E2 1SL43FCH41AB | E2 1SL43FCH49AB | E2 1SL23FCH41AB | E2 1SL23FCH49AB |
| yellow | ↘ | E2 1SL13FCH51AB | E2 1SL13FCH59AB | E2 1SL43FCH51AB | E2 1SL43FCH59AB | E2 1SL23FCH51AB | E2 1SL23FCH59AB |
| blue | ↘ | E2 1SL13FCH61AB | E2 1SL13FCH69AB | E2 1SL43FCH61AB | E2 1SL43FCH69AB | E2 1SL23FCH61AB | E2 1SL23FCH69AB |
| orange | ↘ | E2 1SL13FCH81AB | E2 1SL13FCH89AB | E2 1SL43FCH81AB | E2 1SL43FCH89AB | E2 1SL23FCH81AB | E2 1SL23FCH89AB |
| white | ↕ | E2 1SL13GCH21AB | E2 1SL13GCH29AB | E2 1SL43GCH21AB | E2 1SL43GCH29AB | E2 1SL23GCH21AB | E2 1SL23GCH29AB |
| red | ↕ | E2 1SL13GCH31AB | E2 1SL13GCH39AB | E2 1SL43GCH31AB | E2 1SL43GCH39AB | E2 1SL23GCH31AB | E2 1SL23GCH39AB |
| green | ↕ | E2 1SL13GCH41AB | E2 1SL13GCH49AB | E2 1SL43GCH41AB | E2 1SL43GCH49AB | E2 1SL23GCH41AB | E2 1SL23GCH49AB |
| yellow | ↕ | E2 1SL13GCH51AB | E2 1SL13GCH59AB | E2 1SL43GCH51AB | E2 1SL43GCH59AB | E2 1SL23GCH51AB | E2 1SL23GCH59AB |
| blue | ↕ | E2 1SL13GCH61AB | E2 1SL13GCH69AB | E2 1SL43GCH61AB | E2 1SL43GCH69AB | E2 1SL23GCH61AB | E2 1SL23GCH69AB |
| orange | ↕ | E2 1SL13GCH81AB | E2 1SL13GCH89AB | E2 1SL43GCH81AB | E2 1SL43GCH89AB | E2 1SL23GCH81AB | E2 1SL23GCH89AB |

Legend Maintained Spring-return

On request, knob selector switches can be customized with symbols and inscriptions.

3-slot mounting adapter

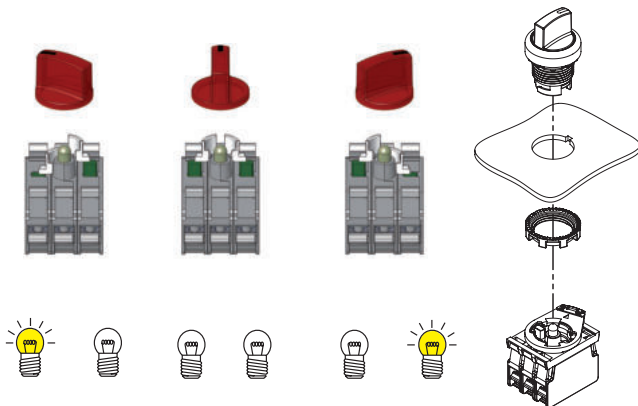

The illuminated 3-position selector switches are supplied with white actuators that activate the contact blocks as the figure shows.

Other combinations on request.

Selection table for complete units with four-position selectors

Four-position selector switches

Illuminated four-position selector switches



| Actuator colour and engraving | Four positions | Contacts | | | 4 positions | | Contacts | | | 4 positions, illuminated | |
|-------------------------------|----------------|----------|--------|---------|----------------|--------------------|----------|--------|---------|--------------------------|--------------------|
| | | pos. 2 | pos. 3 | pos. 1 | black bezel | Satin chrome bezel | pos. 2 | pos. 3 | pos. 1 | black bezel | Satin chrome bezel |
| black | | 1NO+1NC | - | 1NO+1NC | E2 AC-DXBC2201 | E2 AC-DXBC2203 | - | - | - | - | - |
| white | | 1NO+1NC | - | 1NO+1NC | E2 AC-DXBC2209 | E2 AC-DXBC2211 | 1NO+1NC | LED | 1NO+1NC | E2 AC-DXBC2257 | E2 AC-DXBC2259 |
| red | | 1NO+1NC | - | 1NO+1NC | E2 AC-DXBC2217 | E2 AC-DXBC2219 | 1NO+1NC | LED | 1NO+1NC | E2 AC-DXBC2265 | E2 AC-DXBC2267 |
| green | | 1NO+1NC | - | 1NO+1NC | E2 AC-DXBC2225 | E2 AC-DXBC2227 | 1NO+1NC | LED | 1NO+1NC | E2 AC-DXBC2273 | E2 AC-DXBC2275 |
| yellow | | 1NO+1NC | - | 1NO+1NC | E2 AC-DXBC2233 | E2 AC-DXBC2235 | 1NO+1NC | LED | 1NO+1NC | E2 AC-DXBC2281 | E2 AC-DXBC2283 |
| blue | | 1NO+1NC | - | 1NO+1NC | E2 AC-DXBC2241 | E2 AC-DXBC2243 | 1NO+1NC | LED | 1NO+1NC | E2 AC-DXBC2289 | E2 AC-DXBC2291 |
| orange | | 1NO+1NC | - | 1NO+1NC | E2 AC-DXBC2249 | E2 AC-DXBC2251 | 1NO+1NC | LED | 1NO+1NC | E2 AC-DXBC2297 | E2 AC-DXBC2299 |
| black | | 1NO+1NC | - | 1NO+1NC | E2 AC-DXBC2200 | E2 AC-DXBC2202 | - | - | - | - | - |
| white | | 1NO+1NC | - | 1NO+1NC | E2 AC-DXBC2208 | E2 AC-DXBC2210 | 1NO+1NC | LED | 1NO+1NC | E2 AC-DXBC2256 | E2 AC-DXBC2258 |
| red | | 1NO+1NC | - | 1NO+1NC | E2 AC-DXBC2216 | E2 AC-DXBC2218 | 1NO+1NC | LED | 1NO+1NC | E2 AC-DXBC2264 | E2 AC-DXBC2266 |
| green | | 1NO+1NC | - | 1NO+1NC | E2 AC-DXBC2224 | E2 AC-DXBC2226 | 1NO+1NC | LED | 1NO+1NC | E2 AC-DXBC2272 | E2 AC-DXBC2274 |
| yellow | | 1NO+1NC | - | 1NO+1NC | E2 AC-DXBC2232 | E2 AC-DXBC2234 | 1NO+1NC | LED | 1NO+1NC | E2 AC-DXBC2280 | E2 AC-DXBC2282 |
| blue | | 1NO+1NC | - | 1NO+1NC | E2 AC-DXBC2240 | E2 AC-DXBC2242 | 1NO+1NC | LED | 1NO+1NC | E2 AC-DXBC2288 | E2 AC-DXBC2290 |
| orange | | 1NO+1NC | - | 1NO+1NC | E2 AC-DXBC2248 | E2 AC-DXBC2250 | 1NO+1NC | LED | 1NO+1NC | E2 AC-DXBC2296 | E2 AC-DXBC2298 |

Legend: Maintained Spring-return

Note: The LED supplied with the illuminated selector switch has a supply voltage of 12 ... 30 Vac/dc. Other voltages on request.

Contact diagram

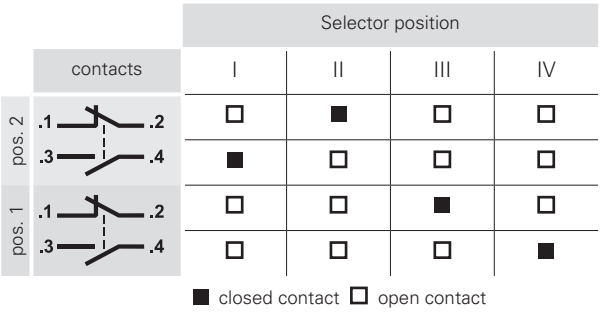

Four-position selector switches

The combination of this version of the selector with the dedicated double contact blocks allows to close a single contact in each of the four positions; the angular rotation of the lever remains the same for versions with 2, 3 and 4 positions, thus facilitating the handling of the device.
The 4-position selector must not be combined with contact blocks different from those supplied.

Grip type

The four-position selector can be supplied with three different grip types. For further information contact our sales office.

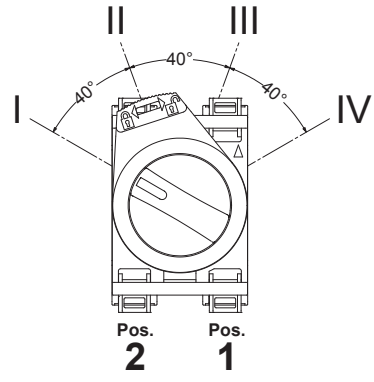

with short handle



with long handle



with knob

Complete units with two- or three-position selectors



| Actuator colour and engraving | Positions | Contacts | | | 2 positions |
|-------------------------------|-----------|----------|--------|--------|---|
| | | pos. 2 | pos. 3 | pos. 1 | black bezel |
| ● black | ∨ | - | 1NO | - | E2 AC-DXBC1401 E2 1SE12AVA11AB + E2 1BAC11 + E2 CP10G2V1 |
| ● black | ∨↻ | - | 1NO | - | E2 AC-DXBC1402 E2 1SE12EVA11AB + E2 1BAC11 + E2 CP10G2V1 |

Other combinations on request.



| Actuator colour and engraving | Positions | Contacts | | | 3 positions |
|-------------------------------|-----------|----------|--------|--------|---|
| | | pos. 2 | pos. 3 | pos. 1 | black bezel |
| ● black | ∨ | 1NO | - | 1NO | E2 AC-DXBC1405 E2 1SE13ACE11AB + E2 1BAC11 + E2 CP10G2V1 + E2 CP10G2V1 |
| ● black | ∨↻ | 1NO | - | 1NO | E2 AC-DXBC1406 E2 1SE13GCE11AB + E2 1BAC11 + E2 CP10G2V1 + E2 CP10G2V1 |

Other combinations on request.

Complete units with two- or three-position illuminated selectors



| Actuator colour and engraving | Positions | Contacts | | | 2 positions |
|-------------------------------|-----------|----------|--------|----------|---|
| | | pos. 2 | pos. 3 | pos. 1 | black bezel |
| ○ white | ∨ | 1NO | LED | 1NC ⊕ | E2 AC-DXBC1805 E2 1SL12AVD21AB + E2 1BAC11 + E2 CP10G2V1 + E2 LP1A2V1 + E2 CP01G2V1 |
| ● green | ∨ | 1NO | LED | 1NC ⊕ | E2 AC-DXBC1801 E2 1SL12AVD41AB + E2 1BAC11 + E2 CP10G2V1 + E2 LP1A4V1 + E2 CP01G2V1 |

Other combinations on request.



| Actuator colour and engraving | Positions | Contacts | | | 3 positions |
|-------------------------------|-----------|----------|--------|----------|---|
| | | pos. 2 | pos. 3 | pos. 1 | black bezel |
| ○ white | ∨ | 1NO | LED | 1NC ⊕ | E2 AC-DXBC1806 E2 1SL13ACH21AB + E2 1BAC11 + E2 CP10G2V1 + E2 LP1A2V1 + E2 CP01G2V1 |
| ● green | ∨ | 1NO | LED | 1NC ⊕ | E2 AC-DXBC1803 E2 1SL13ACH41AB + E2 1BAC11 + E2 CP10G2V1 + E2 LP1A4V1 + E2 CP01G2V1 |

Other combinations on request.

Legend: ∨ Maintained ∨↻ Spring-return

→ For data regarding contact blocks and LED units, please see the respective chapters.

Minimum distances for installation

All values in the drawings are in mm

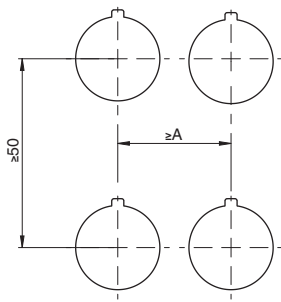

3-slot mounting adapter
A=30 mm
4-slot mounting adapter
A=40 mm

Maximum number of contact blocks

3-slot mounting adapter

4-slot mounting adapter

Selector switches
E2 •SE••••••••

Illuminated selector switches
E2 •SL••••••••

Selector switches
E2 •SE••••••••

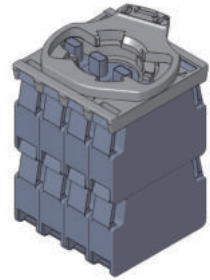
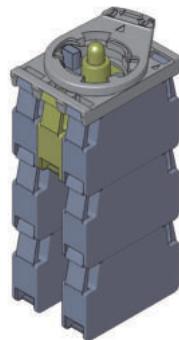
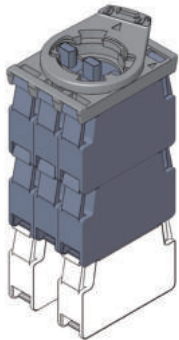

maximum number:
6 contact blocks
3 levels

maximum number:
6 contact blocks
3 levels

maximum number:
8 contact blocks
2 levels

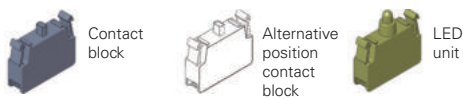
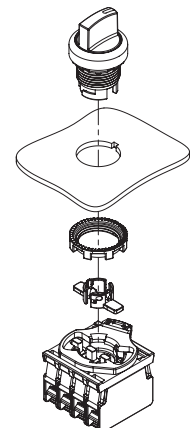
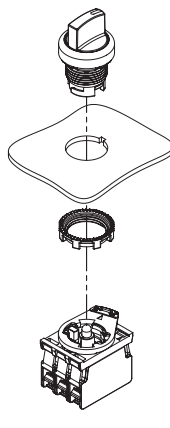
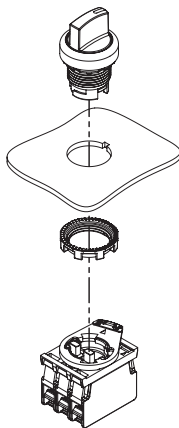

The mounting of the actuators for 4-slot base must be carried out after fixing the selector.

Dimensional drawings

All values in the drawings are in mm

Selector switch with short handle

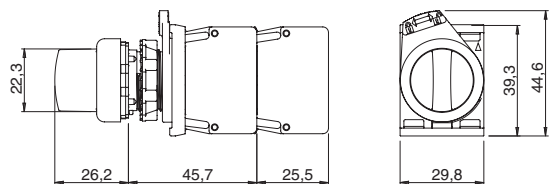

Knob selector switch

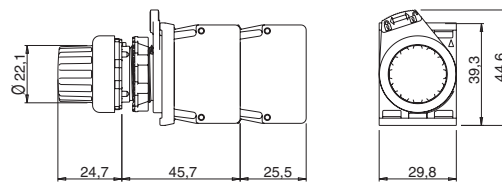

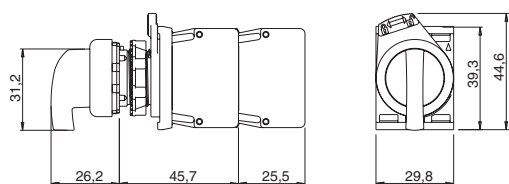

Selector switch with long handle



→ The 2D and 3D files are available at www.pizzato.com

Actuators

Packs of 10 pcs.

| Article | Description |
|--|---|
|  VE AS1212 | Black closed actuator for 3-slot base. Actuates 2 contact blocks at the same time. For E2 ●SE●●●●●● selector switches |
|  VE AS1213 | White open actuator for 3-slot base. Actuates 1 contact block. For E2 ●SE●●●●●●, E2 ●SL●●●●●● selector switches |
|  VE AS1216 | Grey closed actuator for 4-slot base. Actuates 2 contact blocks at the same time. For E2 ●SE●●●●●● selector switches |

Note: 2 actuators needed for each selector.

Shaped ring

Packs of 50 pcs.

| Article | Description |
|--|-------------------------------|
|  VE GP12H1A | Shaped ring for single device |
| Not applicable in presence of label holders, adapters from Ø 22 to Ø 30 mm, guards or protection caps. | |

Fixing ring

Packs of 20 pcs.

| Article | Description |
|---|-------------------|
|  VE GF720A | Metal fixing ring |

Accessories

→ More ACCESSORIES on page 161

Selection diagram

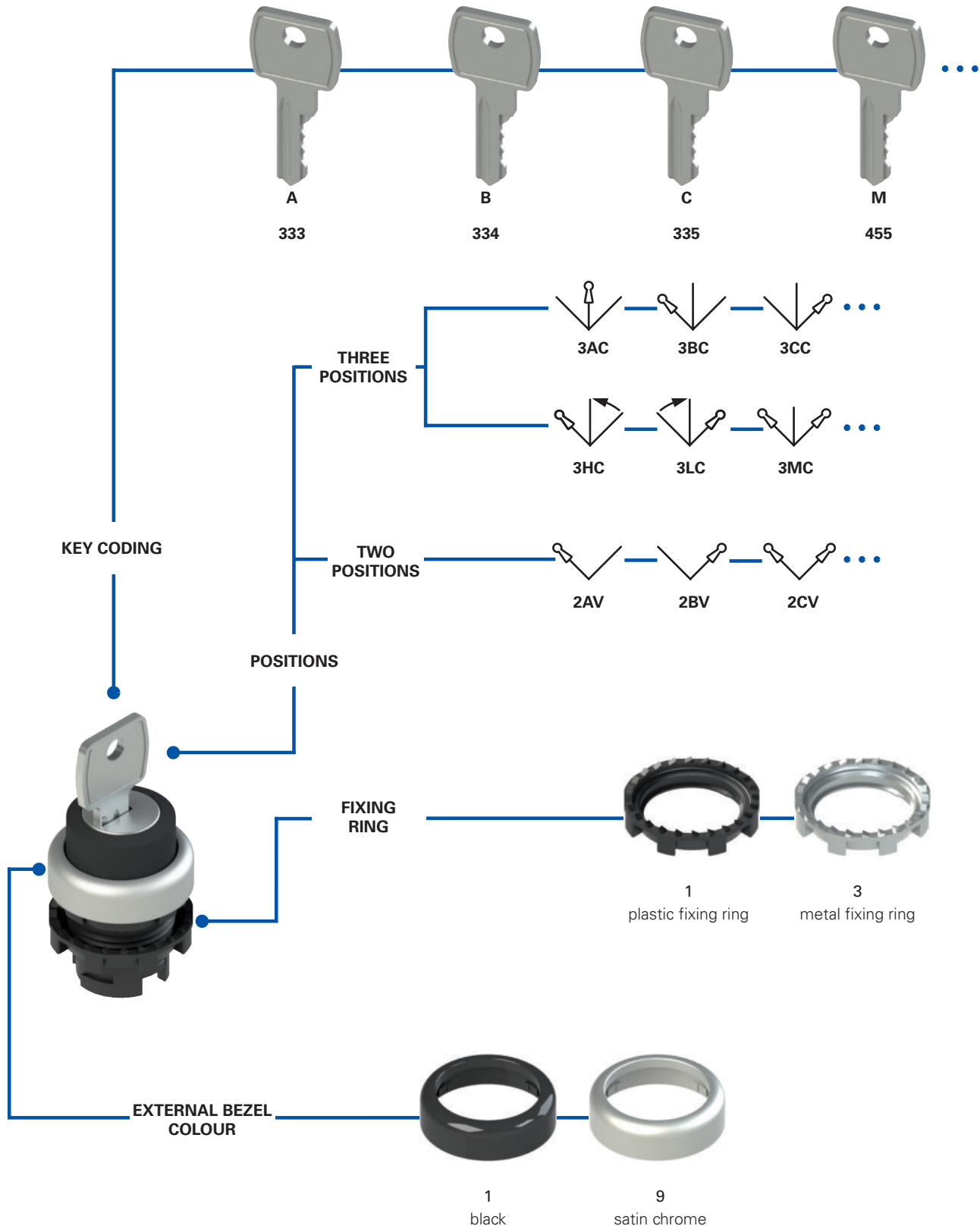





















Code structure **Attention!** The feasibility of a code number does not mean the effective availability of a product. Please contact our sales office.



article options

E2 1SC2ACA11AA-T6



| Fixing ring and shaped ring | |
|-----------------------------|-------------------------------------|
| 1 | plastic fixing ring (standard) |
| 2 | plastic fixing ring and shaped ring |
| 3 | metal fixing ring |
| 4 | metal fixing ring and shaped ring |

| Ambient temperature | |
|---------------------|----------------------------|
| | -25°C ... +80°C (standard) |
| T6 | -40°C ... +80°C |

| Positions and key removal | | | | | |
|---------------------------|---|------------|---|------------|---|
| 2AV |  | 3AC |  | 3HC |  |
| 2BV |  | 3BC |  | 3LC |  |
| 2CV |  | 3CC |  | 3MC |  |
| 2DV |  | 3DC |  | 3NC |  |
| 2AC |  | 3EC |  | 3PC |  |
| 2BC |  | 3FC |  | 3QC |  |
| 2DC |  | 3GC |  | 3RC |  |

Legend:  Maintained  Spring-return  Key extraction position

| Cams and actuators | |
|--------------------|--|
| A | cam for 2-position selector switch for 3-slot base |
| E | cam for 3-position selector switch for 3-slot base |
| Q | cam for 2-position selector switch for 4-slot base |
| R | cam for 3-position selector switch for 4-slot base |

| Marking type | |
|--------------|--|
| A | no inscription (standard) |
| C |  for selector switches only, positions 2AC, 2BC, 2DC |
| D |  for three-position selector switches only |
| E |  for selector switches only, positions 2AV, 2BV, 2CV, 2DV |

Other combinations on request.

| Key coding | |
|------------|---------------------------|
| A | Key coding 333 (standard) |
| B | Key coding 334 |
| C | Key coding 335 |
| ... | ... |
| M | Key coding 455 |

Other key codes on request.

| Bezel colour | |
|--------------|-------------------------|
| 1 | black (standard) |
| 9 | satin chrome (standard) |

| Selector colour | |
|-----------------|-------|
| 1 | black |



Main features

- Protection degrees IP67 and IP69K
- Maintained or spring-return version

Quality marks:



IMQ approval: CA02.04805
 UL approval: E131787
 EAC approval: RU C-IT.YT03.B.00035/19

Technical data

General data

| | |
|---------------------------------------|--|
| Protection degree: | IP67 acc. to EN 60529 IP69K acc. to ISO 20653 |
| Ambient temperature: | -25°C ... +80°C (standard) -40°C ... +80°C (T6 option) |
| Safety parameter B_{10D} : | 600,000 |
| Mechanical endurance: | 300,000 operating cycles |
| Max. actuation frequency: | 3600 operating cycles/hour |
| Actuating force at limit of travel: | 0.07 Nm (without contacts) |
| Maximum travel: | 60° (2 stable positions) 40° (2 momentary positions) ±60° (3 stable positions) ±40° (3 momentary positions) |
| Tightening torque of the fixing ring: | 2 ... 2.5 Nm |
| Utilization requirements: | see page 169 |

In compliance with standards:

IEC 60947-1, IEC 60947-5-1, IEC 60204-1, EN 60947-1, EN 60947-5-1, EN 60204-1, EN IEC 63000, UL 508, CSA C22.2 No. 14.

⚠ Installation for safety applications:

Use only contact blocks marked with the symbol ⊕. The safety circuit must always be connected to **NC contacts** (normally closed contacts: .1-2).

Compliance with the requirements of:

Low Voltage Directive 2014/35/EU, EMC Directive 2014/30/EU, RoHS Directive 2011/65/EU.

Positive contact opening in conformity with standards:

IEC 60947-5-1, EN 60947-5-1.

Features approved by UL

For Use on a Flat Surface of a Type 1, 4X, 12 and 13
 Tightening torque 2.0 Nm

General data

Protection degrees IP67 and IP69K

IP69K
IP67

These devices are designed to be used under the toughest environmental conditions, and they pass the IP67 immersion test acc. to EN 60529. They can therefore be used in all environments where the maximum degree of protection is required for the housing. Due to

their special design, these devices are suitable for use in equipment subjected to cleaning with high pressure hot water jets. These devices meet the IP69K test requirements according to ISO 20653 (water jets with 100 bar and 80°C).

Metal fixing ring



The fixing ring in metal is particularly suitable for those applications which require tighter fitting of the panel-mounted device, such as for example in metal panels having holes without reference notches.

Shaped ring

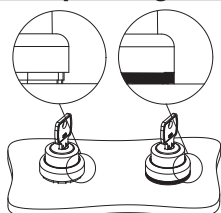

The shaped ring can be used when no label holder or other devices are applied; it prevents dirt and other residues from settling between the selector switch and the panel or housing. This turns out to be particularly useful in the sectors where high standards of cleanness and hygiene are required.

Actuators for selector switches





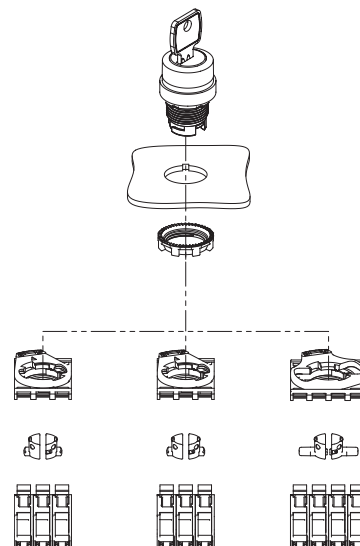

Three types of actuators are available, which activate the cursors of the contacts combined with the selector: a white actuator allowing the commutation of a single contact block, and a black or grey actuator allowing the simultaneous commutation of two contact blocks next to each other.

The white, black (3-slot base) and grey (4-slot base) actuators can be removed and replaced at any moment. This allows to configure at will the switching type executed by the selector on the contacts.

















Selection table for key selector switches





| Actuator colour and engraving | Two positions | with key | |
|-------------------------------|---|----------------|--------------------|
| | | black bezel | Satin chrome bezel |
| ● black |  | E2 1SC2AVA11AA | E2 1SC2AVA19AA |
| |  | E2 1SC2BVA11AA | E2 1SC2BVA19AA |
| |  | E2 1SC2CVA11AA | E2 1SC2CVA19AA |
| |  | E2 1SC2DVA11AA | E2 1SC2DVA19AA |
| |  | E2 1SC2ACA11AA | E2 1SC2ACA19AA |
| |  | E2 1SC2BCA11AA | E2 1SC2BCA19AA |
| |  | E2 1SC2DCA11AA | E2 1SC2DCA19AA |

The standard colour of the selectors in the above-mentioned codes is **BLACK**. Other colours on request.
 Key selectors switches can be customized with symbols and inscriptions on request.
 All keys of the selector switches have the 333 key coding. Other codes on request.



| Actuator colour and engraving | Three positions | with key | |
|---|---|----------------|--------------------|
| | | black bezel | Satin chrome bezel |
| ● black |  | E2 1SC3ACE11AA | E2 1SC3ACE19AA |
| |  | E2 1SC3BCE11AA | E2 1SC3BCE19AA |
| |  | E2 1SC3CCE11AA | E2 1SC3CCE19AA |
| |  | E2 1SC3DCE11AA | E2 1SC3DCE19AA |
| |  | E2 1SC3ECE11AA | E2 1SC3ECE19AA |
| |  | E2 1SC3FCE11AA | E2 1SC3FCE19AA |
| |  | E2 1SC3GCE11AA | E2 1SC3GCE19AA |
| |  | E2 1SC3HCE11AA | E2 1SC3HCE19AA |
| |  | E2 1SC3LCE11AA | E2 1SC3LCE19AA |
| |  | E2 1SC3MCE11AA | E2 1SC3MCE19AA |
| |  | E2 1SC3NCE11AA | E2 1SC3NCE19AA |
| |  | E2 1SC3PCE11AA | E2 1SC3PCE19AA |
| |  | E2 1SC3QCE11AA | E2 1SC3QCE19AA |
|  | E2 1SC3RCE11AA | E2 1SC3RCE19AA | |

The standard colour of the selectors in the above-mentioned codes is **BLACK**. Other colours on request.
 Key selectors switches can be customized with symbols and inscriptions on request.
 All keys of the selector switches have the 333 key coding. Other codes on request.

Legend:  Maintained  Spring-return  Key extraction position

3-slot mounting adapter

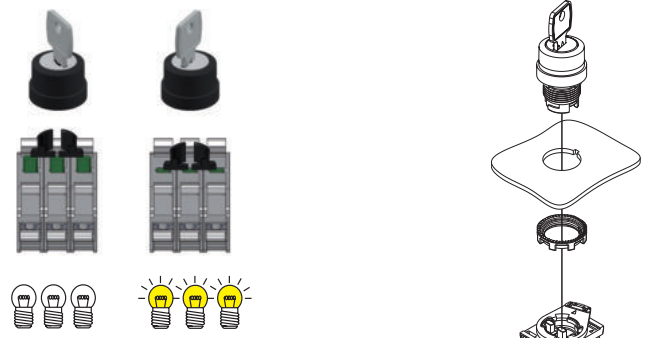

The 2-position selector switches actuate all contacts at the same time.

4-slot mounting adapter

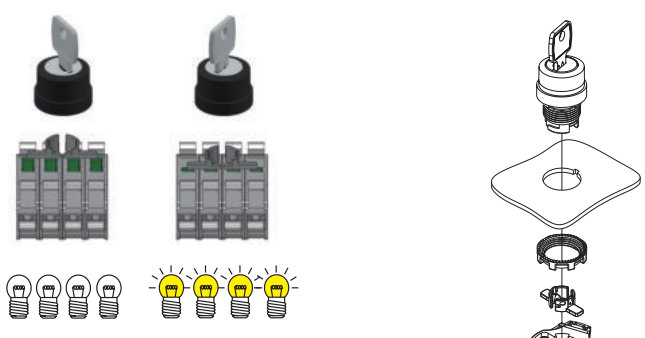

The 2-position selector switches actuate all contacts at the same time.

3-slot mounting adapter

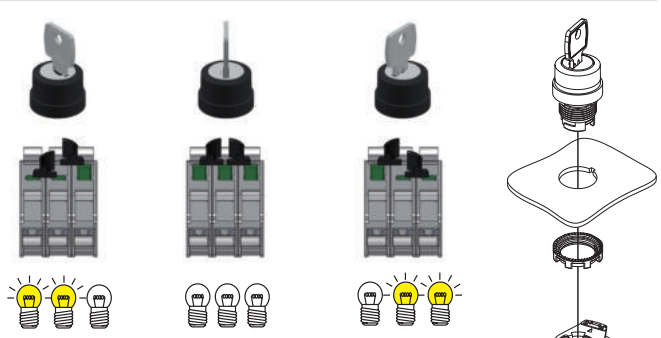

The 3-position selector switches are supplied with black actuators that activate 2 contacts at the same time.

4-slot mounting adapter

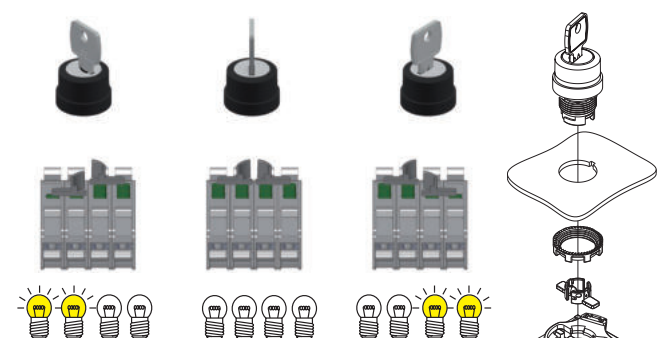

The 3-position selector switches are supplied with grey actuators that activate 2 contacts at the same time.

Complete units with two- or three-position key selectors



| Actuator colour and engraving | Positions | Contacts | | | 2 positions |
|-------------------------------|-----------|----------|--------|--------|--|
| | | pos. 2 | pos. 3 | pos. 1 | black bezel |
| ● black | | - | 1NO | - | E2 AC-DXBC1601 E2 1SC2AVA11AA + E2 1BAC11 + E2 CP10G2V1 |
| ● black | | - | 1NO | - | E2 AC-DXBC1605 E2 1SC2CVA11AA + E2 1BAC11 + E2 CP10G2V1 |
| ● black | | - | 1NO | - | E2 AC-DXBC1606 E2 1SC2DVA11AA + E2 1BAC11 + E2 CP10G2V1 |

Other combinations on request.
Key with key coding 333.

Legend: Maintained Spring-return Key extraction position

→ [For data regarding contact blocks, please see the respective chapters.](#)

| Actuator colour and engraving | Positions | Contacts | | | 3 positions |
|-------------------------------|-----------|----------|--------|--------|--|
| | | pos. 2 | pos. 3 | pos. 1 | black bezel |
| ● black | | 1NO | - | 1NO | E2 AC-DXBC1607 E2 1SC3DCE11AA + E2 1BAC11 + E2 CP10G2V1 + E2 CP10G2V1 |

Other combinations on request.
Key with key coding 333.

Minimum distances for installation All values in the drawings are in mm

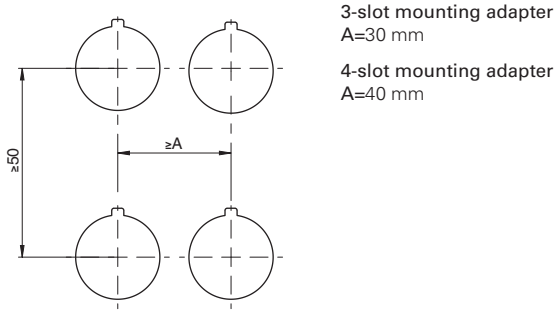

Maximum number of contact blocks

3-slot mounting adapter
E2 •SC•••••••• key selector switch

4-slot mounting adapter
E2 •SC•••••••• key selector switch

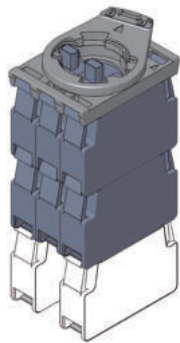

maximum number:
6 contact blocks
3 levels

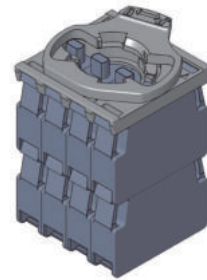
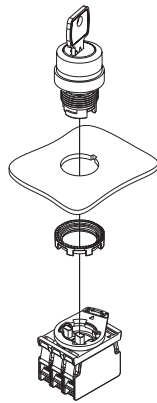

maximum number:
8 contact blocks
2 levels

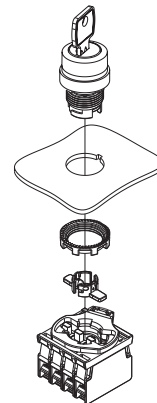

The mounting of the actuators for 4-slot base must be carried out after fixing the selector.

Dimensional drawings

All values in the drawings are in mm

Key selector switch

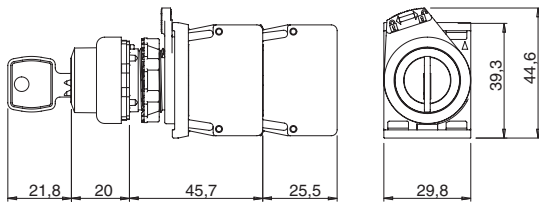

→ The 2D and 3D files are available at www.pizzato.com

Locking keys



| Article | Description |
|-----------------|-------------|
| VE KE1A00-PY333 | Locking key |



Order only if further keys besides the supplied one are needed.
Key with key coding 333.
Other codes on request.

Actuators

Packs of **10 pcs.**

| Article | Description |
|---|--|
|  VE AS1212 | Black closed actuator for 3-slot base. Actuates 2 contact blocks at the same time. |
|  VE AS1213 | White open actuator for 3-slot base. Actuates 1 contact block. |
|  VE AS1216 | Grey closed actuator for 4-slot base. Actuates 2 contact blocks at the same time. |

Note: 2 actuators needed for each selector.

Shaped ring

Packs of **50 pcs.**

| Article | Description |
|--|-------------------------------|
|  VE GP12H1A | Shaped ring for single device |

Not applicable in presence of label holders, adapters from Ø 22 to Ø 30 mm, guards or protection caps.

Fixing ring

Packs of **20 pcs.**

| Article | Description |
|---|-------------------|
|  VE GF720A | Metal fixing ring |

Accessories

→ More ACCESSORIES on page 161

Selection diagram

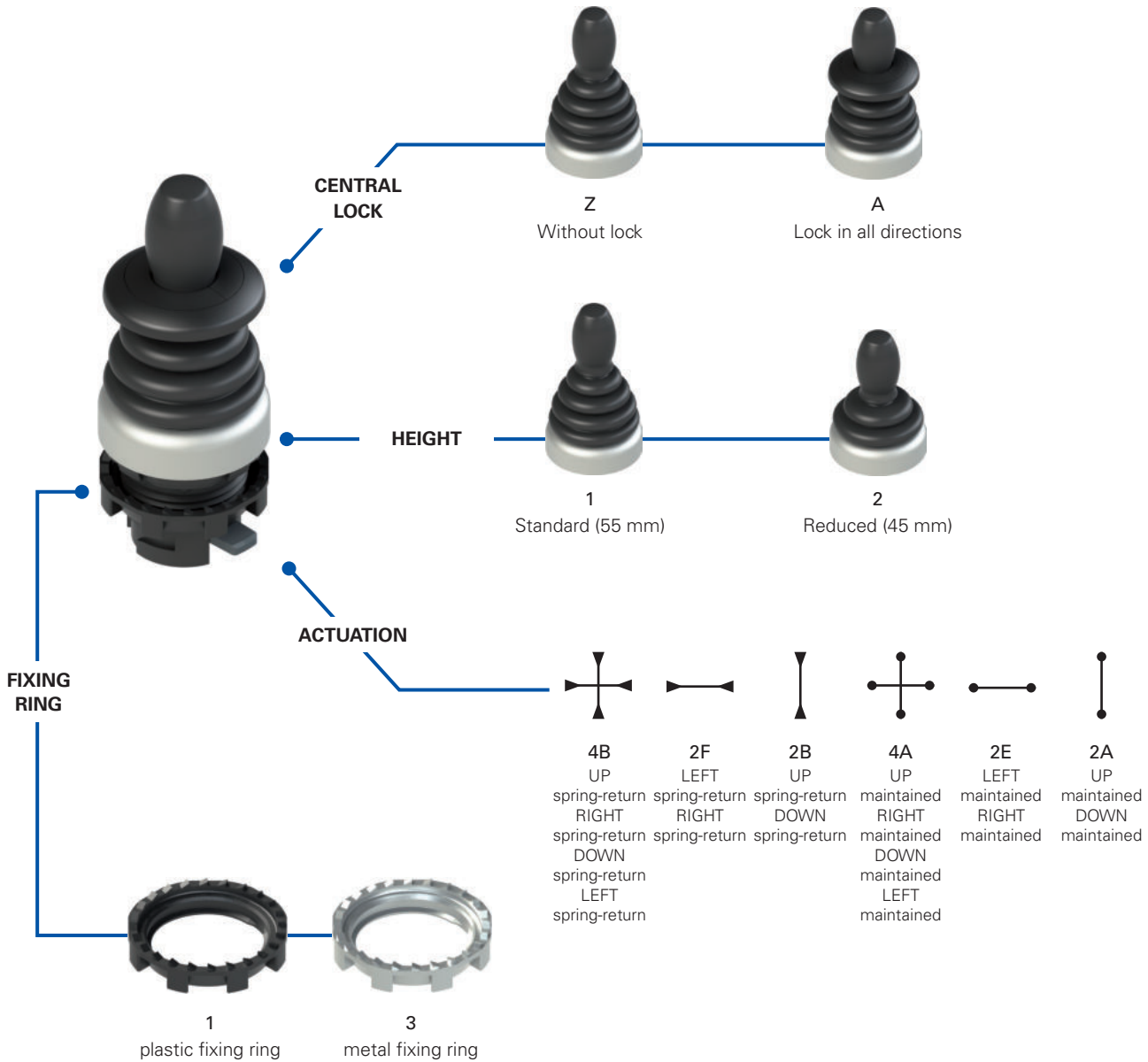

Code structure

Attention! The feasibility of a code number does not mean the effective availability of a product. Please contact our sales office.

E2 1MA14BZ91

| Fixing ring and shaped ring | |
|-----------------------------|-------------------------------------|
| 1 | plastic fixing ring (standard) |
| 2 | plastic fixing ring and shaped ring |
| 3 | metal fixing ring |
| 4 | metal fixing ring and shaped ring |

| Joystick height | |
|-----------------|------------------|
| 1 | Standard (55 mm) |
| 2 | Reduced (45 mm) |

| Lock | |
|------|------------------------|
| Z | Without lock |
| A | Lock in all directions |

| Actuation | |
|-----------|---|
| 4B | UP spring-return, RIGHT spring-return, DOWN spring-return, LEFT spring-return |
| 2F | LEFT spring-return, RIGHT spring-return |
| 2B | UP spring-return, DOWN spring-return |
| 4A | UP maintained, RIGHT maintained, DOWN maintained, LEFT maintained |
| 2E | LEFT maintained, RIGHT maintained |
| 2A | UP maintained, DOWN maintained |



Main features

- Protection degrees IP67 and IP69K
- 2 possible heights: standard (55 mm) and reduced (45 mm)
- Versions with central lock
- Versions with spring-return or maintained actuation
- Two-step actuation

Quality marks:



IMQ approval: CA02.04805
 UL approval: E131787
 EAC approval: RU C-IT.YT03.B.00035/19

Technical data

General data

| | |
|---------------------------------------|--|
| Protection degree: | IP67 acc. to EN 60529 IP69K acc. to ISO 20653 |
| Ambient temperature: | -40°C ... +80°C |
| Safety parameter B _{10D} : | 2,000,000 |
| Mechanical endurance: | 1 million operating cycles 500,000 unblocking operating cycles |
| Max. actuation frequency: | 3600 operating cycles/hour |
| Actuating force: | 0.17 Nm (spring-return actuation) 0.3 Nm (maintained actuation) |
| Maximum travel: | 35° |
| Tightening torque of the fixing ring: | 2 ... 2.5 Nm |
| Utilization requirements: | see page 169 |

In compliance with standards:

IEC 60947-1, IEC 60947-5-1, IEC 60204-1, EN 60947-1, EN 60947-5-1, EN 60204-1, EN IEC 63000, UL 508, CSA C22.2 No. 14.

⚠ Installation for safety applications:

Use only contact blocks marked with the symbol ⊕. The safety circuit must always be connected to **NC contacts** (normally closed contacts: .1-.2)

Compliance with the requirements of:

Low Voltage Directive 2014/35/EU,
 EMC Directive 2014/30/EU,
 RoHS Directive 2011/65/EU.

Positive contact opening in conformity with standards:

IEC 60947-5-1, EN 60947-5-1.

Features approved by UL

For Use on a Flat Surface of a Type 1, 4X, 12 and 13
 Tightening torque 2.0 Nm

General data

Protection degrees IP67 and IP69K

IP69K
IP67

The elastic hood of the Pizzato joystick is made in a single seamless piece that completely encloses the lever, in this way without leaving the minimum aperture or junction.

This particular solution (patent pending) is present in all the versions of the joystick,

including the versions with reduced height and central lock and is the most effective method for ensuring protection from all possible infiltrations of dirt and water. These devices can therefore be used in all environments where the maximum protection of the housing is required and pass both the IP67 immersion test according to EN 60529 and test IP69K according to ISO 20653 with jets of water at 100 bar and temperature 80°C.

Central lock

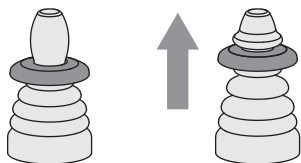

To prevent accidental operation, the joystick can be ordered in versions with central lock.

In these versions the lever remains fixed in the central position and can be steered in the various directions only after

being unlocked by simply pulling the release disk. The pulling release movement avoids unwanted unlocking actions.

Easy configuration of the contacts

The joystick is paired with a mounting adapter with four slots, thus allowing to associate different types of contact blocks to every single direction of actuation. Single or double contact blocks, even on two levels, can be used.

There are therefore no constraints on the type of contact block, the users can freely install the standard contact block in the configuration they prefer.



Two-step actuation

Two-step actuation in every direction is possible by connecting in series to the normal NO contact blocks additional NO contact blocks provided with early make contacts. This option can be used for example to control two-speed actuations in the same direction.

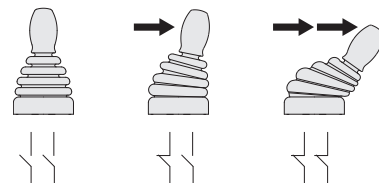

Maintained or spring-return actuation

Versions with 2 or 4 directions are available, and the single directions can have a maintained actuation, in which the lever remains in the tilted position, or spring-return actuation, in which the lever automatically returns to the central position.

Two compact forms

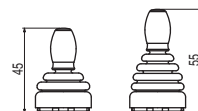

With the standard height version (55 mm), there is also a reduced height (45 mm) version, ideal for all situations where a low height is required. Even so, the reduced height version of the joystick does not dispense with any of

the standard version options, such as the possibility of being provided with central lock.

Labels for the joystick



The joystick can be paired with specific circular and rectangular labels. This accessory, available in black or grey colour, is the ideal complement for the joystick at both the functional and aesthetic level, creating an assembly of original and elegant design. The labels specify with

clear indications the functions performed by the joystick, and can be customised with symbols or written text. The laser-engraved markings are indelible. The application of the label does not alter the IP protection degree of the device.

Selection table



| Functions | | Standard height (55 mm) without lock | Standard height (55 mm) with lock | Reduced height (45 mm) without lock | Reduced height (45 mm) with lock |
|-----------|--|--------------------------------------|-----------------------------------|-------------------------------------|----------------------------------|
| | | Satin chrome bezel | Satin chrome bezel | Satin chrome bezel | Satin chrome bezel |
| | UP spring-return, RIGHT spring-return, DOWN spring-return, LEFT spring-return | E2 1MA14BZ91 | E2 1MA14BA91 | E2 1MA24BZ91 | E2 1MA24BA91 |
| | LEFT spring-return, RIGHT spring-return | E2 1MA12FZ91 | E2 1MA12FA91 | E2 1MA22FZ91 | E2 1MA22FA91 |
| | UP spring-return, DOWN spring-return | E2 1MA12BZ91 | E2 1MA12BA91 | E2 1MA22BZ91 | E2 1MA22BA91 |
| | UP maintained, RIGHT maintained, DOWN maintained, LEFT maintained | E2 1MA14AZ91 | E2 1MA14AA91 | E2 1MA24AZ91 | E2 1MA24AA91 |
| | LEFT maintained, RIGHT maintained | E2 1MA12EZ91 | E2 1MA12EA91 | E2 1MA22EZ91 | E2 1MA22EA91 |
| | UP maintained, DOWN maintained | E2 1MA12AZ91 | E2 1MA12AA91 | E2 1MA22AZ91 | E2 1MA22AA91 |

Selection table for complete units



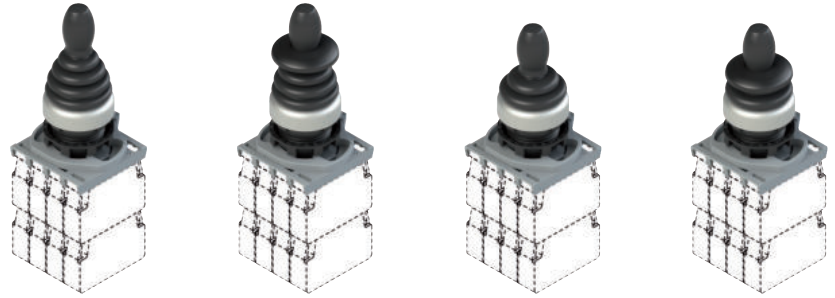

| Functions | | Contacts | | | | Standard height (55 mm) without lock | Standard height (55 mm) with lock | Reduced height (45 mm) without lock | Reduced height (45 mm) with lock |
|-----------|--|----------|--------|--------|--------|---|---|---|---|
| | | pos. 3 | pos. 2 | pos. 4 | pos. 1 | Satin chrome bezel | Satin chrome bezel | Satin chrome bezel | Satin chrome bezel |
| | UP spring-return, RIGHT spring-return, DOWN spring-return, LEFT spring-return | 1NO | 1NO | 1NO | 1NO | E2 AC-DXBC2602 E2 1MA14BZ91 + E2 1BAC21 + 4x E2 CP10G2V1 | E2 AC-DXBC2604 E2 1MA14BA91 + E2 1BAC21 + 4x E2 CP10G2V1 | E2 AC-DXBC2603 E2 1MA24BZ91 + E2 1BAC21 + 4x E2 CP10G2V1 | E2 AC-DXBC2605 E2 1MA24BA91 + E2 1BAC21 + 4x E2 CP10G2V1 |
| | LEFT spring-return, RIGHT spring-return | 1NO | | | 1NO | E2 AC-DXBC2601 E2 1MA12FZ91 + E2 1BAC21 + 2x E2 CP10G2V1 | E2 AC-DXBC2613 E2 1MA12FA91 + E2 1BAC21 + 2x E2 CP10G2V1 | E2 AC-DXBC2618 E2 1MA22FZ91 + E2 1BAC21 + 2x E2 CP10G2V1 | E2 AC-DXBC2622 E2 1MA22FA91 + E2 1BAC21 + 2x E2 CP10G2V1 |
| | UP spring-return, DOWN spring-return | | 1NO | 1NO | | E2 AC-DXBC2600 E2 1MA12BZ91 + E2 1BAC21 + 2x E2 CP10G2V1 | E2 AC-DXBC2611 E2 1MA12BA91 + E2 1BAC21 + 2x E2 CP10G2V1 | E2 AC-DXBC2616 E2 1MA22BZ91 + E2 1BAC21 + 2x E2 CP10G2V1 | E2 AC-DXBC2620 E2 1MA22BA91 + E2 1BAC21 + 2x E2 CP10G2V1 |
| | UP maintained, RIGHT maintained, DOWN maintained, LEFT maintained | 1NO | 1NO | 1NO | 1NO | E2 AC-DXBC2608 E2 1MA14AZ91 + E2 1BAC21 + 4x E2 CP10G2V1 | E2 AC-DXBC2614 E2 1MA14AA91 + E2 1BAC21 + 4x E2 CP10G2V1 | E2 AC-DXBC2609 E2 1MA24AZ91 + E2 1BAC21 + 4x E2 CP10G2V1 | E2 AC-DXBC2623 E2 1MA24AA91 + E2 1BAC21 + 4x E2 CP10G2V1 |
| | LEFT maintained, RIGHT maintained | 1NO | | | 1NO | E2 AC-DXBC2607 E2 1MA12EZ91 + E2 1BAC21 + 2x E2 CP10G2V1 | E2 AC-DXBC2612 E2 1MA12EA91 + E2 1BAC21 + 2x E2 CP10G2V1 | E2 AC-DXBC2617 E2 1MA22EZ91 + E2 1BAC21 + 2x E2 CP10G2V1 | E2 AC-DXBC2621 E2 1MA22EA91 + E2 1BAC21 + 2x E2 CP10G2V1 |
| | UP maintained, DOWN maintained | | 1NO | 1NO | | E2 AC-DXBC2606 E2 1MA12AZ91 + E2 1BAC21 + 2x E2 CP10G2V1 | E2 AC-DXBC2610 E2 1MA12AA91 + E2 1BAC21 + 2x E2 CP10G2V1 | E2 AC-DXBC2615 E2 1MA22AZ91 + E2 1BAC21 + 2x E2 CP10G2V1 | E2 AC-DXBC2619 E2 1MA22AA91 + E2 1BAC21 + 2x E2 CP10G2V1 |

Selection table for complete units with two-step actuation



| Functions | | Contacts | | | | Standard height (55 mm) without lock | Standard height (55 mm) with lock | Reduced height (45 mm) without lock | Reduced height (45 mm) with lock |
|---|--|----------|----------|----------|----------|--|--|--|--|
| | | pos. 3 | pos. 2 | pos. 4 | pos. 1 | Satin chrome bezel | Satin chrome bezel | Satin chrome bezel | Satin chrome bezel |
|  | UP spring-return, RIGHT spring-return, DOWN spring-return, LEFT spring-return | 1NO + | 1NO + | 1NO + | 1NO + | E2 AC-DXBC2626 E2 1MA14BZ91 + E2 1BAC21 + 4x E2 CP10G2V1 + 4x E2 CP10L2V1 | E2 AC-DXBC2629 E2 1MA14BA91 + E2 1BAC21 + 4x E2 CP10G2V1 + 4x E2 CP10L2V1 | E2 AC-DXBC2632 E2 1MA24BZ91 + E2 1BAC21 + 4x E2 CP10G2V1 + 4x E2 CP10L2V1 | E2 AC-DXBC2635 E2 1MA24BA91 + E2 1BAC21 + 4x E2 CP10G2V1 + 4x E2 CP10L2V1 |
|  | LEFT spring-return, RIGHT spring-return | 1NO + | | | 1NO + | E2 AC-DXBC2625 E2 1MA12FZ91 + E2 1BAC21 + 2x E2 CP10G2V1 + 2x E2 CP10L2V1 | E2 AC-DXBC2628 E2 1MA12FA91 + E2 1BAC21 + 2x E2 CP10G2V1 + 2x E2 CP10L2V1 | E2 AC-DXBC2631 E2 1MA22FZ91 + E2 1BAC21 + 2x E2 CP10G2V1 + 2x E2 CP10L2V1 | E2 AC-DXBC2634 E2 1MA22FA91 + E2 1BAC21 + 2x E2 CP10G2V1 + 2x E2 CP10L2V1 |
|  | UP spring-return, DOWN spring-return | | 1NO + | 1NO + | | E2 AC-DXBC2624 E2 1MA12BZ91 + E2 1BAC21 + 2x E2 CP10G2V1 + 2x E2 CP10L2V1 | E2 AC-DXBC2627 E2 1MA12BA91 + E2 1BAC21 + 2x E2 CP10G2V1 + 2x E2 CP10L2V1 | E2 AC-DXBC2630 E2 1MA22BZ91 + E2 1BAC21 + 2x E2 CP10G2V1 + 2x E2 CP10L2V1 | E2 AC-DXBC2633 E2 1MA22BA91 + E2 1BAC21 + 2x E2 CP10G2V1 + 2x E2 CP10L2V1 |

Legend:
 maintained actuation
 spring-return actuation

Dimensional drawings

All values in the drawings are in mm

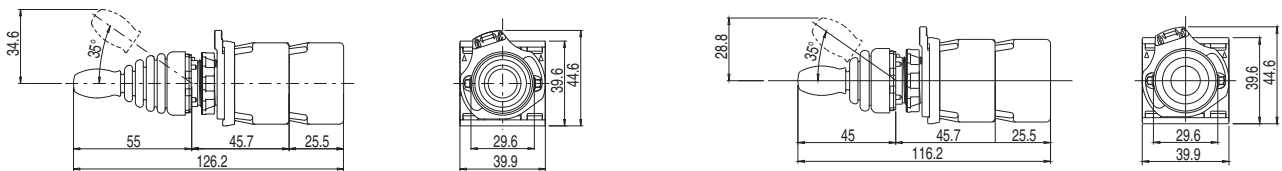

Minimum distances for installation

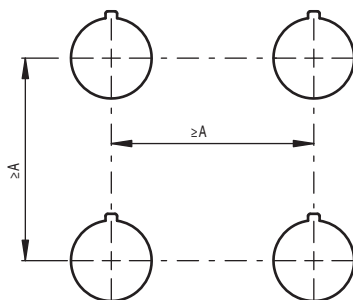

Standard height joystick
A=70 mm

Reduced height joystick
A=60 mm

→ The 2D and 3D files are available at www.pizzato.com

Maximum number of contact blocks

4-slot mounting adapter

Joystick E2 •MA••••••••

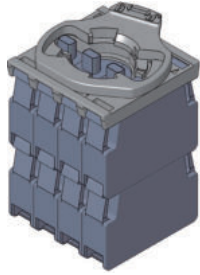

maximum number:
8 contact blocks
2 levels

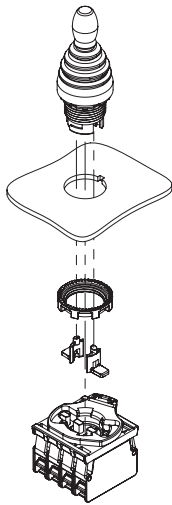

The assembly of the 2 lateral actuators, supplied with the joystick, must be done after the fixing of the joystick.

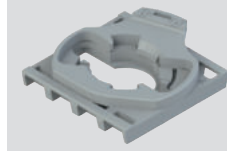

Contact block

Mounting adapterPacks of **10 pcs.**

| Article | Description |
|-----------|---|
| E2 1BAC21 | 4-slot mounting adapter for E2 CP•••••••• contact block |

Shaped ringPacks of **50 pcs.**

| Article | Description |
|--|-------------------------------|
| VE GP12H1A | Shaped ring for single device |
| Not applicable in presence of circular or rectangular label, adapters from Ø 22 to Ø 30 mm or protection guards. | |

Fixing ringPacks of **20 pcs.**

| Article | Description |
|-----------|-------------------|
| VE GF720A | Metal fixing ring |

Accessories

➔ More ACCESSORIES on page 161

Labels with shaped hole

Suitable for devices E2 •MA••••••.
 Can be turned in 90° steps.
 Upon request with different engravings or inscriptions in other languages.
It does not alter the IP67 / IP69K protection degree of the associated device.

| Article | Description |
|--|--|
|  VE TF32A9133 | Label with shaped hole, circular, Ø 60 mm, grey, inscription: ▲ ▸ ▾ ◀ |
|  VE TF12A1233 | Label with shaped hole, circular, Ø 60 mm, black, inscription: ▲ ▸ ▾ ◀ |
|  VE TF32G9134 | Label with shaped hole, rectangular, 30x60 mm, grey, inscription: ▲ ▾ |
|  VE TF12G1234 | Label with shaped hole, rectangular, 30x60 mm, black, inscription: ▲ ▾ |

| Article | Description |
|--|--|
|  VE TF32A9130 | Label with shaped hole, circular, Ø 60 mm, grey, inscription: UP ▲ R ▸ DOWN ▾ L ◀ |
|  VE TF12A1230 | Label with shaped hole, circular, Ø 60 mm, black, inscription: UP ▲ R ▸ DOWN ▾ L ◀ |
|  VE TF32G9131 | Label with shaped hole, rectangular, 30x60 mm, grey, inscription: UP ▲ DOWN ▾ |
|  VE TF12G1231 | Label with shaped hole, rectangular, 30x60 mm, black, inscription: UP ▲ DOWN ▾ |
|  VE TF32G9132 | Label with shaped hole, rectangular, 30x60 mm, grey, inscription: R ▸ L ◀ |
|  VE TF12G1232 | Label with shaped hole, rectangular, 30x60 mm, black, inscription: R ▸ L ◀ |

Windowed protection guard

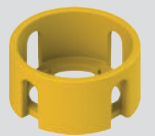
| Article | Description |
|--|--|
|  VE GP32A5A | Cylindrical yellow protection guard with 4 windows Ø 40x20 mm Suitable for reduced height joystick. |

It does not alter the IP protection degree of the associated device.

Cylindrical protection guard

| Article | Description |
|--|---|
|  VE GP32B5A | Cylindrical yellow protection guard Ø 43x27 mm Suitable for standard height joystick. Available in various colours. See page 164. |

It does not alter the IP protection degree of the associated device.

Open protection guard

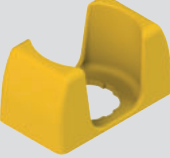
| Article | Description |
|--|---|
|  VE GP32F5A | Rectangular open yellow protection guard 66x38 mm, 35 mm high, complete with 4 screws (for panels of thickness from 1 to 3.5 mm) Suitable for the two-direction, standard and reduced height joystick. |

It does not alter the IP protection degree of the associated device.

Application examples of guards

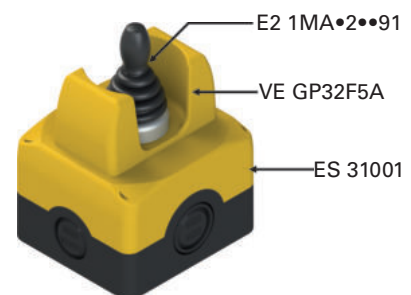
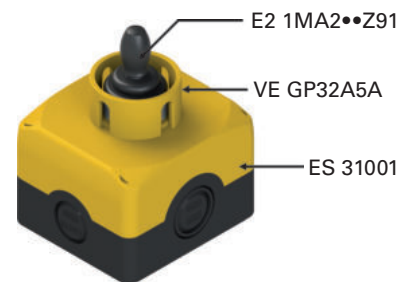

→ The 2D and 3D files are available at www.pizzato.com

Selection diagram

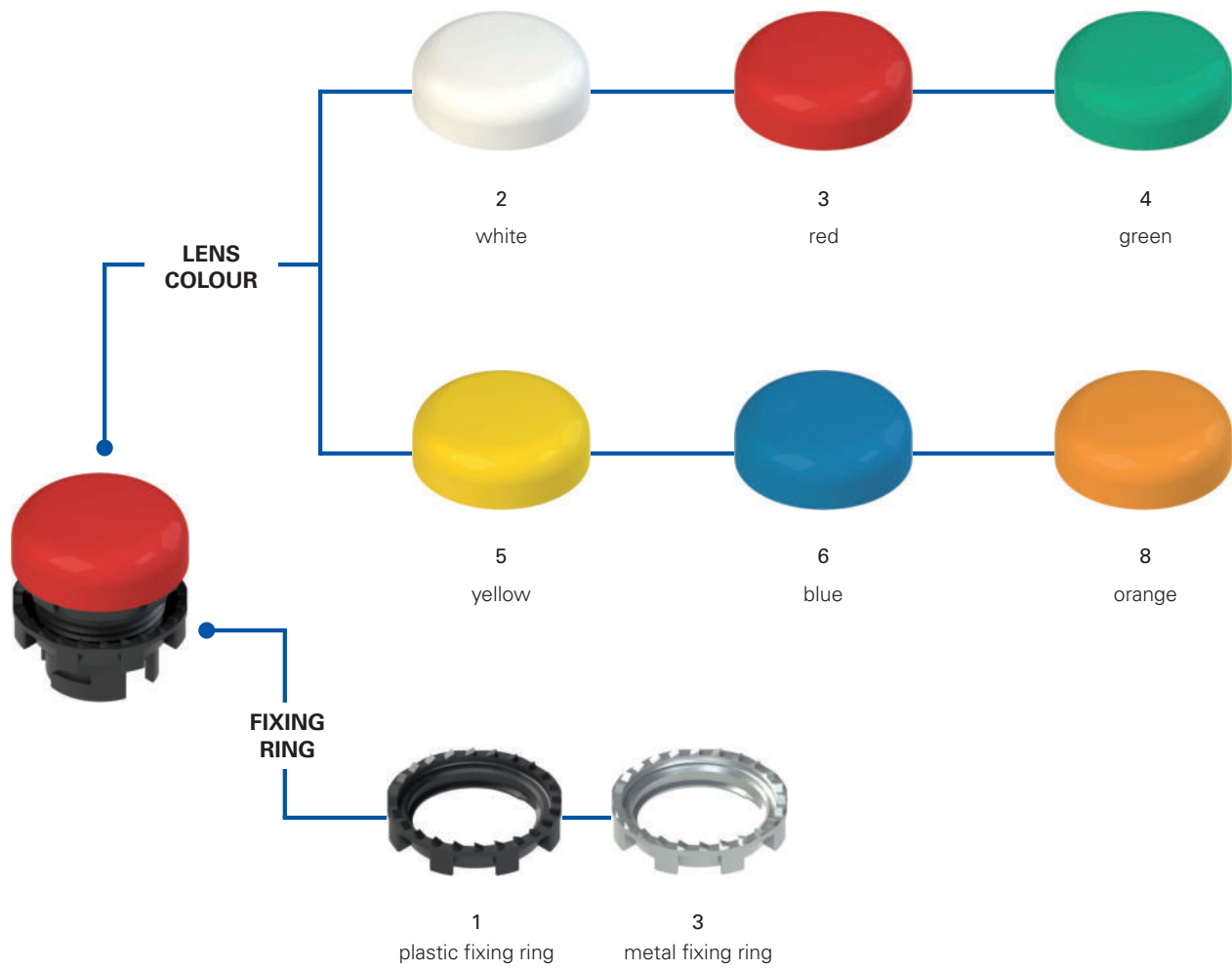

Code structure **Attention!** The feasibility of a code number does not mean the effective availability of a product. Please contact our sales office.

E2 1ILA210

| Fixing ring and shaped ring | |
|-----------------------------|-------------------------------------|
| 1 | plastic fixing ring (standard) |
| 2 | plastic fixing ring and shaped ring |
| 3 | metal fixing ring |
| 4 | metal fixing ring and shaped ring |

| Engraving | |
|------------|---|
| 0 | no engraving (standard) |
| IT7 | IN SERVIZIO |
| IT8 | ERROR |
| L54 |  |
| ... | ... |

Other engravings on request. See page 165.

| Lens shape | |
|------------|---------------|
| A | level, smooth |

| Lens colour | |
|-------------|--------------|
| 0 | without lens |
| 2 | white |
| 3 | red |
| 4 | green |
| 5 | yellow |
| 6 | blue |
| 8 | orange |



Main features

- Protection degrees IP67 and IP69K
- Customisation with symbols available
- Replaceable coloured lens

Quality marks:



IMQ approval: CA02.04806
 UL approval: E131787
 EAC approval: RU C-IT.YT03.B.00035/19

Technical data

General data

| | |
|---------------------------------------|--|
| Protection degree: | IP67 acc. to EN 60529 IP69K acc. to ISO 20653 |
| Ambient temperature: | -25°C ... +70°C |
| Lighting type: | Combined with lighting unit with LED series E2 LP●●●●, E2 LF●●●● |
| Tightening torque of the fixing ring: | 2 ... 2.5 Nm |
| Utilization requirements: | see page 169 |

In compliance with standards:

IEC 60947-1, IEC 60947-5-1, IEC 60204-1, EN 60947-1, EN 60947-5-1, EN 60204-1, EN IEC 63000, UL 508, CSA C22.2 No. 14.

Compliance with the requirements of:

Low Voltage Directive 2014/35/EU,
 EMC Directive 2014/30/EU,
 RoHS Directive 2011/65/EU.

Features approved by UL

For Use on a Flat Surface of a Type 1, 4X, 12 and 13
 Tightening torque 2.0 Nm

General data

Protection degrees IP67 and IP69K

IP69K
IP67

These devices are designed to be used under the toughest environmental conditions, and they pass the IP67 immersion test acc. to EN 60529. They can therefore be used in all environments where the maximum degree

of protection is required for the housing. Due to their special design, these devices are suitable for use in equipment subjected to cleaning with high pressure hot water jets. These devices meet the IP69K test requirements according to ISO 20653 (water jets with 100 bar and 80°C).

Customisable



In order to suit various customer requests and different kinds of application, Pizzato Elettrica offers the possibility to customize the indicator lights with symbols, inscriptions and interchangeable lenses with different colours.

Metal fixing ring



The fixing ring in metal is particularly suitable for those applications which require tighter fitting of the panel-mounted device, such as for example in metal panels having holes without reference notches.

Shaped ring

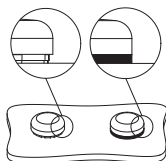

The shaped ring can be used when no label holder or other devices are applied; it prevents dirt and other residues from settling between the indicator and the panel or housing.

This turns out to be particularly useful in the sectors where high standards of cleanness and hygiene are required.

Combination of LED colours with lens colours

| LED colour | Lens colour |
|------------|----------------|
| white | white / yellow |
| red | red |
| green | green |
| blue | blue |
| orange | orange |

Note:Combinations of LED colour with lens colour different from the recommended ones can give a different colour compared to the expected one.



Selection table for indicator lights



| Actuator colour and engraving | With lens | Without lens |
|--|------------|--------------|
|  without lens | - | E2 11LA010 |
|  white | E2 11LA210 | - |
|  red | E2 11LA310 | - |
|  green | E2 11LA410 | - |
|  yellow | E2 11LA510 | - |
|  blue | E2 11LA610 | - |
|  orange | E2 11LA810 | - |

Complete units with indicator lights





















| Actuator colour and engraving | LED | | | Article |
|--|--------|--------|--------|---|
| | pos. 2 | pos. 3 | pos. 1 | |
|  white | - | LED | - | E2 AC-DXBC0200 E2 11LA210 + E2 1BAC11 + E2 LP1A2V1 |
|  red | - | LED | - | E2 AC-DXBC0201 E2 11LA310 + E2 1BAC11 + E2 LP1A3V1 |
|  green | - | LED | - | E2 AC-DXBC0202 E2 11LA410 + E2 1BAC11 + E2 LP1A4V1 |
|  yellow | - | LED | - | E2 AC-DXBC0203 E2 11LA510 + E2 1BAC11 + E2 LP1A2V1 |
|  blue | - | LED | - | E2 AC-DXBC0204 E2 11LA610 + E2 1BAC11 + E2 LP1A6V1 |
|  orange | - | LED | - | E2 AC-DXBC0205 E2 11LA810 + E2 1BAC11 + E2 LP1A8V1 |

→ For data regarding LED units, please see the respective chapters

Lenses for E2 •IL indicator lights



| Article | Description | Colours | Pieces/package |
|-------------|---|---|----------------|
| VE LN2A20 | Lens for indicator lights, white, without engraving |  | 10 |
| VE LN2A30 | Lens for indicator lights, red, without engraving |  | 10 |
| VE LN2A40 | Lens for indicator lights, green, without engraving |  | 10 |
| VE LN2A50 | Lens for indicator lights, yellow, without engraving |  | 10 |
| VE LN2A60 | Lens for indicator lights, blue, without engraving |  | 10 |
| VE LN2A80 | Lens for indicator lights, orange, without engraving |  | 10 |
| VE LN2AA0 | 6 lenses for indicator lights, without engraving, colours: white, red, green, yellow, blue orange |       | 1 |
| VE LN2A2●●● | Lens for indicator lights, white, with engraving |  | 1 |
| VE LN2A3●●● | Lens for indicator lights, red, with engraving |  | 1 |
| VE LN2A4●●● | Lens for indicator lights, green, with engraving |  | 1 |
| VE LN2A5●●● | Lens for indicator lights, yellow, with engraving |  | 1 |
| VE LN2A6●●● | Lens for indicator lights, blue, with engraving |  | 1 |
| VE LN2A8●●● | Lens for indicator lights, orange, with engraving |  | 1 |

For ordering engraved lenses for E2 11L indicator lights: replace the dots ●●● in the article codes with the engraving code reported on the table at page 165.
Example: white lens for indicator light with "⚡" engraving.
VE LN2A2●●● → VE LN2A2L54

Minimum distances for installation

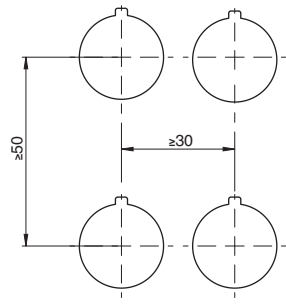

→ The 2D and 3D files are available at www.pizzato.com

Dimensional drawings All values in the drawings are in mm

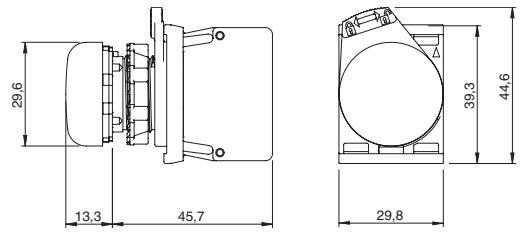

Accessories

→ More ACCESSORIES on page 161

Selection diagram

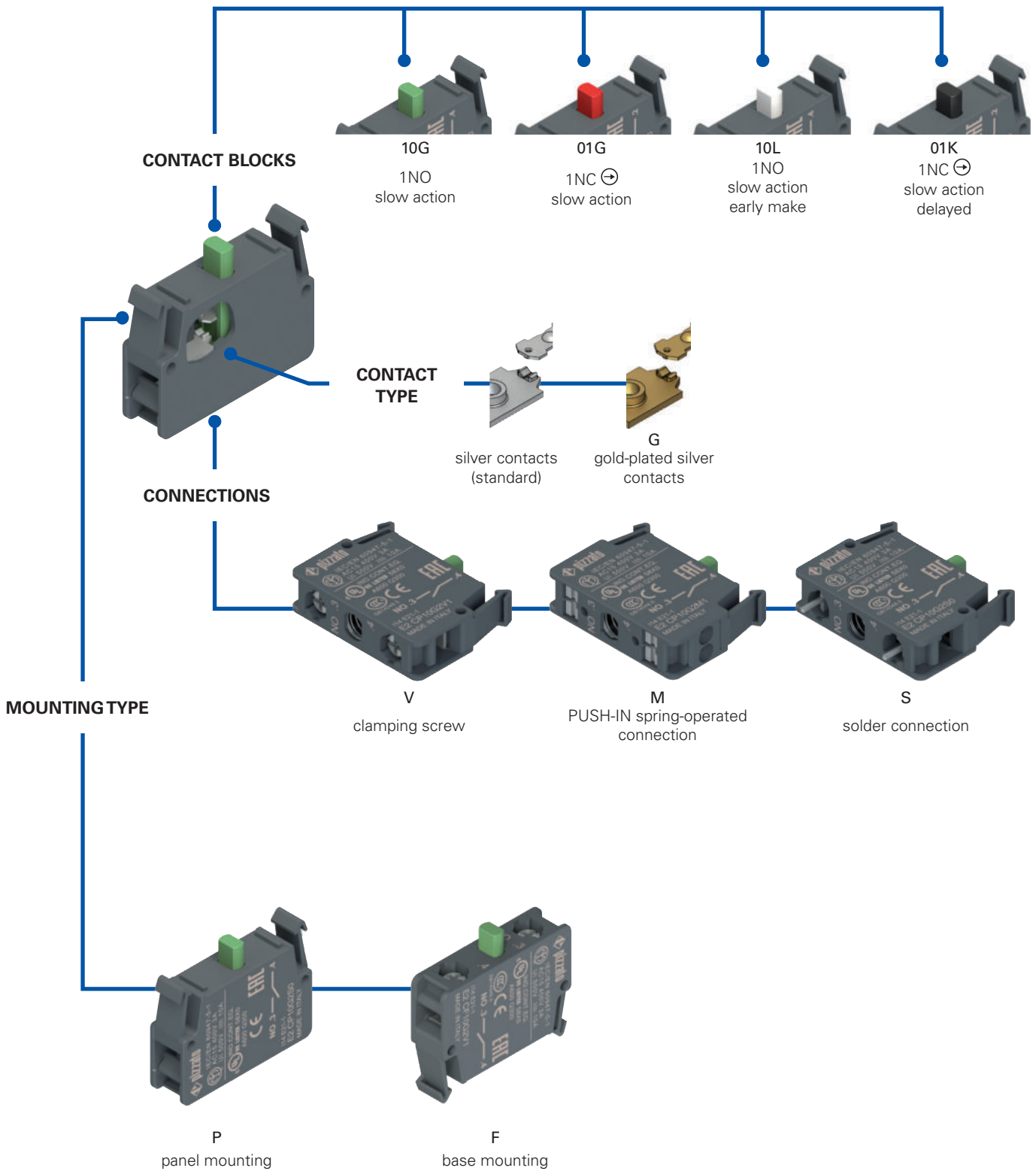

Code structure **Attention!** The feasibility of a code number does not mean the effective availability of a product. Please contact our sales office.

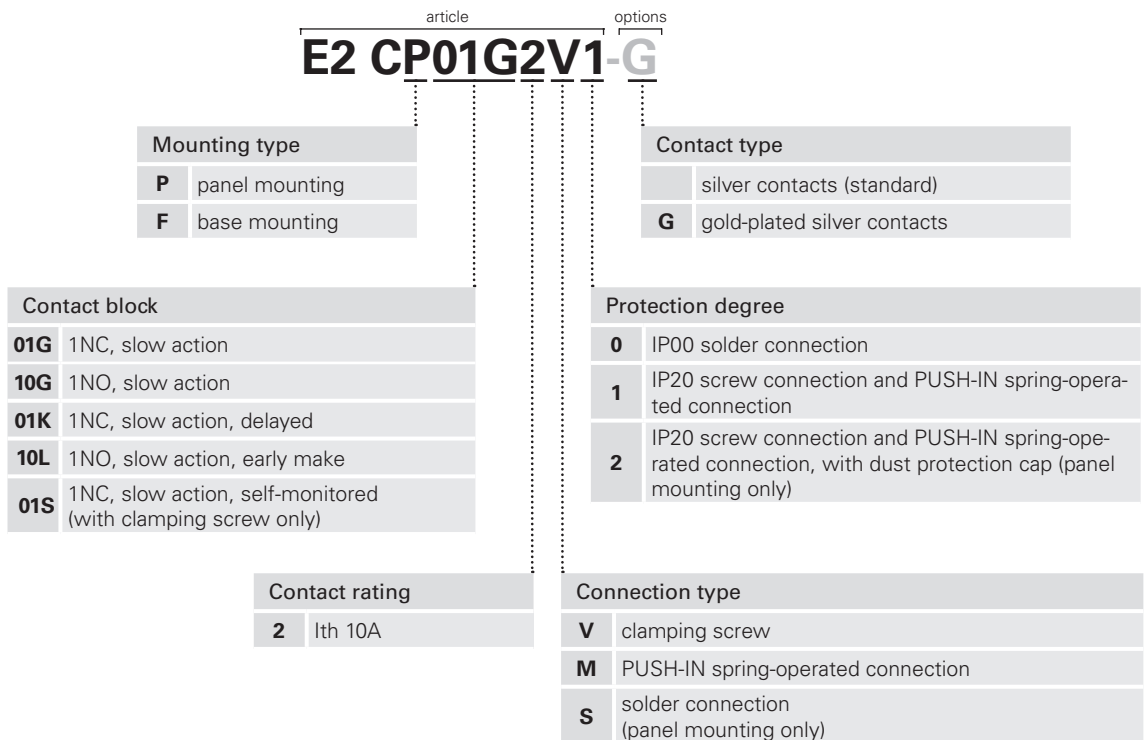

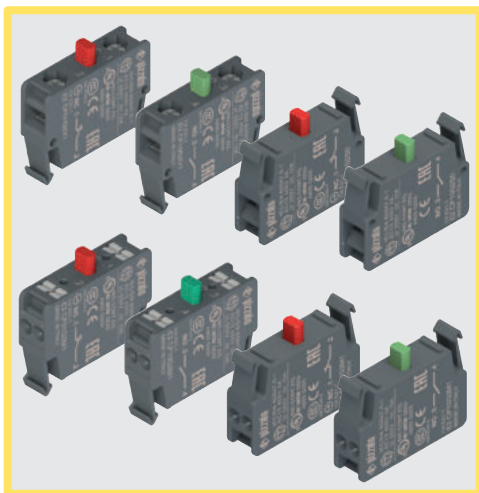

Main features

- Highly reliable contact blocks provided with self-cleaning contacts with quadruple contact point
- Versions with gold-plated contacts
- Positive opening NC contacts acc. to IEC 60947-5-1
- Screw, PUSH-IN spring, or solder connections

Quality marks:



| | |
|---------------|-------------------------|
| IMO approval: | CA02.04805 |
| UL approval: | E131787 |
| CCC approval: | 2021000305000106 |
| EAC approval: | RU C-IT.YT03.B.00035/19 |

Technical data

General data

| | |
|-------------------------------------|---|
| Protection degree acc. to EN 60529: | IP20 with screw connection IP20 with PUSH-IN spring-operated connection IP00 with solder connection |
| Ambient temperature: | -40°C ... +80°C |
| Mechanical endurance: | 20 million operating cycles |
| Max. actuation frequency: | 3600 operating cycles/hour |
| Utilization requirements: | see page 169 |

Contact block

| | |
|-------------------------------------|--|
| Switching force of the contacts: | 1.8 N (NO) / 1.4 N (NC) 1.7 N (NO early make) / 1.4 N (NC delayed) |
| Actuating force at limit of travel: | 3.5 N (NO) / 2.3 N (NC) 3.5 N (NO early make) / 1.9 N (NC delayed) |
| Positive opening force: | 17 N |
| Actuation speed: | min 1 mm/s max. 0.5 m/s |
| Safety parameter B_{10D} : | 1,000,000 (NO), 40,000,000 (NC) |
| Material of the contacts: | Silver contacts (standard) For low current: silver contacts with 1 µm gold coating (on request) |
| Contact type: | "V-shape" self-cleaning contacts with quadruple contact point |

Clamping screw connection

| | |
|-----------------------------|--|
| Cable cross section: | min 1 x 0.5 mm ² (1 x AWG 20) max 2 x 2.5 mm ² (2 x AWG 14) |
| Tightening torque: | 0.6 ... 0.8 Nm |
| Cable stripping length (x): | 8 mm |

PUSH-IN spring-operated connection

| | |
|---|---|
| Cable cross section (flexible conductors, with or without wire-end sleeve): | min. 1 x 0.25 mm ² (1 x AWG 24) max. 2 x 1.5 mm ² (2 x AWG 16) |
| Cable stripping length (x): | min. 8 mm, max. 10 mm |



In compliance with standards:

IEC 60947-1, IEC 60947-5-1, IEC 60204-1, EN 60947-1, EN 60947-5-1, EN 60204-1, EN IEC 63000, UL 508, CSA C22.2 No. 14, GB/T14048.5.

⚠ Installation for safety applications:

Use only contact blocks marked with the symbol \ominus . The safety circuit must always be connected to **NC contacts** (normally closed contacts: .1-2)

Compliance with the requirements of:

Low Voltage Directive 2014/35/EU,
EMC Directive 2014/30/EU,
RoHS Directive 2011/65/EU.

Positive contact opening in conformity with standards:

IEC 60947-5-1, EN 60947-5-1.

Electrical data

| | |
|--|---|
| Thermal current (I_{th}): | 10 A |
| Rated insulation voltage (U_i): | 500 Vac/dc |
| Protection against short circuits: | type gG/gL fuse 10 A 500 V |
| Rated impulse withstand voltage (U_{imp}): | 8 kV screw and solder connection 6 kV PUSH-IN spring-operated connection |
| Pollution degree: | 3 |

Utilization category

| | | | | | |
|--|-----|-----|-----|-----|-----|
| Alternating current: AC15 (50 ... 60 Hz) | | | | | |
| U_e (V) | 24 | 48 | 120 | 250 | 400 |
| I_e (A) | 6 | 6 | 6 | 6 | 3 |
| Direct current: DC13 | | | | | |
| U_e (V) | 24 | 48 | 125 | 250 | |
| I_e (A) | 2.5 | 1.3 | 0.6 | 0.3 | |

Features approved by UL

Electrical ratings: A600 pilot duty (720 VA, 120-600 Vac)
Q300 pilot duty (69 VA, 125-250 Vdc)

Note:
For contact block series E2 C provided with clamping screw terminals: use 60 or 75 °C copper (Cu) conductor and wire size range 14-20 AWG, stranded or solid. The terminal tightening torque of 7.1 Lb In (0.8 Nm).

For contact block series E2 C provided with screw less type terminals: use 60 or 75 °C copper (Cu) conductor and wire size range 16-24 AWG, stranded. These terminals are suitable also for stranded conductors prepared with ZMLF ferrules. Recommended stripping length: 8 mm.

Please contact our technical department for the list of approved products.

Features approved by IMQ

| | | |
|---|--------------------|------|
| Rated insulation voltage (Ui): | 500 V | |
| Conventional free air thermal current (Ith): | | 10 A |
| Thermal current inside housing (Ithe): | 10 A | |
| Rated impulse withstand voltage (Uimp): | | |
| screw terminals or solder terminals | 8 kV | |
| terminals without screw | 6 kV | |
| Protection degree of the housing: | | |
| screw terminals or terminals without screw | | IP20 |
| solder terminals | IP00 | |
| screw terminals with dust protection cap, panel mounting only | IP20 | |
| Terminals: screw terminals, solder terminals, without screw | | |
| Utilization category: | AC15 | |
| Operating voltage (Ue): | 400 Vac (50/60 Hz) | |
| Operating current (Ie): | 3 A | |
| Forms of the contact element: | X, Y | |
| Positive opening of contacts on contact blocks 01G, 01K | | |

In compliance with standards: EN 60947-1, EN 60947-5-1, fundamental requirements of the Low Voltage Directive 2014/35/EU.

Please contact our technical department for the list of approved products.

General data

Positive opening



All NC contacts are suitable for safety applications. The NC contacts are positive opening contacts acc. to IEC 60947-5-1.

Screw connection with clamping screw plates

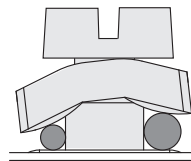

The clamping screw plates of the contact blocks are provided with a particular "roofing tile" structure and are loosely coupled to the clamping screw. This way, during the wires fixing, the clamping screw plate is able to suit to cables of different diameters and tends to tighten the wires toward the screw instead of permitting them to escape towards the outside.

PUSH-IN spring-operated connection



The PUSH-IN spring connection allows quick and simple wiring, as the wire just needs to be inserted into the appropriate hole in order to establish the electrical connection and automatically secure the wire. The reduced force required to insert the wire allows completely tool-free connection by using wires with crimped wire-end sleeves. They are released by pressing a special wire release button - including individually - with any tool, without the need to use a screwdriver of a predefined size. In addition, the contact block has holes for insertion of tester tips, so that electrical measurements can be carried out, without having to remove the connecting cables.

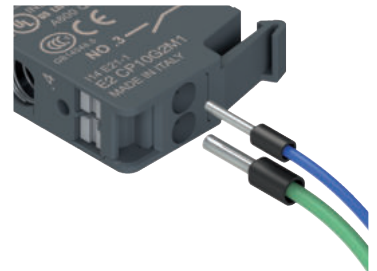

High-reliability self-cleaning contacts

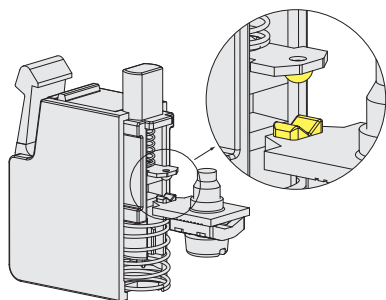

"V-shape" self-cleaning contacts with quadruple contact point. This type of shape, thanks to the presence of the double contact point, makes it possible to drastically reduce the probability of contact commutation failure. In addition to this, it improves considerably the reliability in the presence of dust.

Solder connection on printed circuit

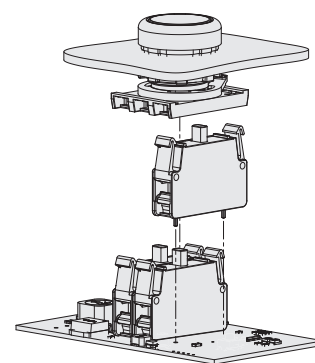

Versions with panel mounting of the EROUND series contact blocks with solder pin are available. If there is no wiring but a printed circuit, these contact blocks can be directly welded on the latter.

Gold-plated silver contacts

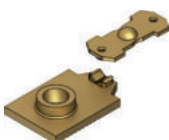

The contact blocks can be supplied with silver electric contacts with a special gold-plated surface, with total gold thickness of one micron. This type of treatment can be useful in environments which are aggressive against silver and in case of very small electric charges, usually with low voltages and supply currents.

Selection table for contact blocks

Packs of 10 pcs.



| Contact block | Panel mounting | | | Base mounting | |
|-----------------------------------|------------------|------------------------------------|-------------------|------------------|------------------------------------|
| | Screw connection | PUSH-IN spring-operated connection | Solder connection | Screw connection | PUSH-IN spring-operated connection |
| 1NC ⊕ slow action | E2 CP01G2V1 | E2 CP01G2M1 | E2 CP01G2S0 | E2 CF01G2V1 | E2 CF01G2M1 |
| 1NO slow action | E2 CP10G2V1 | E2 CP10G2M1 | E2 CP10G2S0 | E2 CF10G2V1 | E2 CF10G2M1 |
| 1NC ⊕ slow action, delayed | E2 CP01K2V1 | E2 CP01K2M1 | E2 CP01K2S0 | E2 CF01K2V1 | E2 CF01K2M1 |
| 1NO slow action, early make | E2 CP10L2V1 | E2 CP10L2M1 | E2 CP10L2S0 | E2 CF10L2V1 | E2 CF10L2M1 |

Complete units with contact block and mounting adapter



| Contacts | | | Panel mounting | |
|----------|--------|--------|--|--|
| pos. 2 | pos. 3 | pos. 1 | Screw connection | PUSH-IN spring-operated connection |
| - | 1NO | - | E2 AC-XXBC0010 E2 1BAC11 + E2 CP10G2V1 | E2 AC-XXBC0147 E2 1BAC11 + E2 CP10G2M1 |
| - | 1NC ⊕ | - | E2 AC-XXBC0009 E2 1BAC11 + E2 CP01G2V1 | E2 AC-XXBC0146 E2 1BAC11 + E2 CP01G2M1 |

Other combinations on request.

| Contacts | | | Panel mounting | |
|----------|--------|--------|---|---|
| pos. 2 | pos. 3 | pos. 1 | Screw connection | PUSH-IN spring-operated connection |
| 1NO | - | 1NO | E2 AC-XXBC0012 E2 1BAC11 + E2 CP10G2V1 + E2 CP10G2V1 | E2 AC-XXBC0149 E2 1BAC11 + E2 CP10G2M1 + E2 CP10G2M1 |
| 1NC ⊕ | - | 1NC ⊕ | E2 AC-XXBC0011 E2 1BAC11 + E2 CP01G2V1 + E2 CP01G2V1 | E2 AC-XXBC0148 E2 1BAC11 + E2 CP01G2M1 + E2 CP01G2M1 |
| 1NC ⊕ | - | 1NO | E2 AC-XXBC0028 E2 1BAC11 + E2 CP10G2V1 + E2 CP01G2V1 | E2 AC-XXBC0150 E2 1BAC11 + E2 CP10G2M1 + E2 CP01G2M1 |

Other combinations on request.

Dimensional drawings

All values in the drawings are in mm

Contact block for panel mounting with screw connection, PUSH-IN spring-operated connection

Contact block for base mounting, with screw connection, PUSH-IN spring-operated connection

Contact block for panel mounting with solder connection

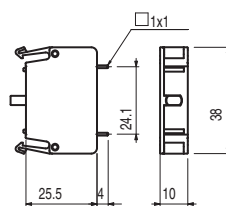
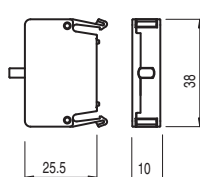
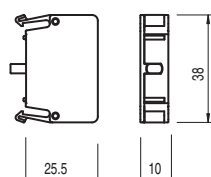

Ø 1.4 mm holes on PCB

Dust protection

Packs of 50 pcs.



| Article | Description |
|-----------|---|
| VE PR3A70 | Transparent dust protection for E2 series contact blocks. Suitable for all panel mounting contact blocks. |

→ The 2D and 3D files are available at www.pizzato.com

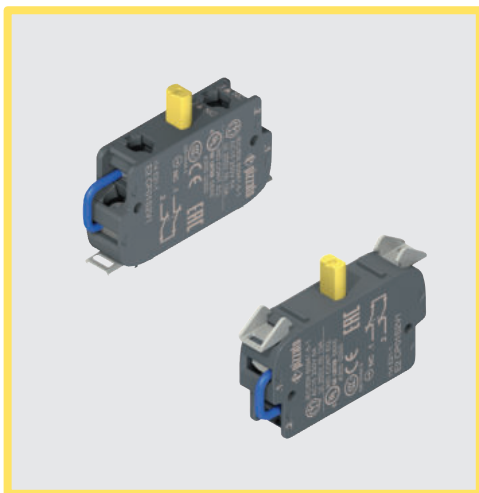

Main features

- Self-monitored contact block. Electrical circuit opening indicates the detachment from the device
- Versions with gold-plated contacts
- Positive opening NC contacts acc. to IEC 60947-5-1

Quality marks:



| | |
|---------------|-------------------------|
| IMQ approval: | CA02.04805 |
| UL approval: | E131787 |
| CCC approval: | 2021000305000106 |
| EAC approval: | RU C-IT.YT03.B.00035/19 |

Technical data

General data

| | |
|---------------------------|--|
| Protection degree: | IP20 acc. to EN 60529 at the terminals |
| Ambient temperature: | -40°C ... +80°C |
| Mechanical endurance: | 20 million operating cycles |
| Max. actuation frequency: | 3600 operating cycles/hour |
| Utilization requirements: | see page 169 |

Contact block

| | |
|-------------------------------------|---|
| Switching force of the contacts: | 2.9 N |
| Actuating force at limit of travel: | 5 N |
| Positive opening force: | 17 N |
| Actuation speed: | min 1 mm/s max. 0.5 m/s |
| Safety parameter B_{10D} : | 40,000,000 (NC) |
| Material of the contacts: | Silver contacts (standard) For low current: silver contacts with 1 μ m gold coating (on request) |

Contact type:

"V-shape" self-cleaning contacts with quadruple contact point

Cable cross section:

min 1 x 0.34 mm² (1 x AWG 22)
max. 2 x 1.5 mm² (2 x AWG 16)

Cable stripping length:

7 mm

Tightening torque of the terminal screws:

0.6 ... 0.8 Nm

In compliance with standards:

IEC 60947-1, IEC 60947-5-1, IEC 60204-1, EN 60947-1, EN 60947-5-1, EN 60204-1, EN IEC 63000, UL 508, CSA C22.2 No. 14, GB/T14048.5

⚠ Installation for safety applications:

Use only contact blocks marked with the symbol . The safety circuit must always be connected to **NC contacts** (normally closed contacts: .1-2)

Compliance with the requirements of:

Low Voltage Directive 2014/35/EU, EMC Directive 2014/30/EU, RoHS Directive 2011/65/EU.

Positive contact opening in conformity with standards:

IEC 60947-5-1, EN 60947-5-1.

Electrical data

| | |
|--|----------------------------|
| Thermal current (I _{th}): | 10 A |
| Rated insulation voltage (U _i): | 250 Vac/dc |
| Protection against short circuits: | type gG/gL fuse 10 A 500 V |
| Rated impulse withstand voltage (U _{imp}): | 4 kV |
| Pollution degree: | 3 |

Utilization category

| | | | | |
|--|-----|-----|-----|-----|
| Alternating current: AC15 (50 ... 60 Hz) | | | | |
| U _e (V) | 24 | 48 | 120 | 250 |
| I _e (A) | 6 | 6 | 6 | 6 |
| Direct current: DC13 | | | | |
| U _e (V) | 24 | 48 | 125 | 250 |
| I _e (A) | 2.5 | 1.3 | 0.6 | 0.3 |

Functioning of self-monitored contact blocks

The operating principle of the self-monitoring contact blocks ensures that their associated control devices are free from faults and malfunctions caused by contacts separating, and that the safety function remains permanently available during machine operation.

Characterised by two NC contacts connected in series; during normal operation, both contacts are in the closed position.

If the emergency stop button is pressed, the direct action of the force exerted on the control device opens the first contact (positive opening); this interrupts the safety circuit, while the second contact remains closed.

If the housing cover is removed (in the case of base-mounted contact blocks), or if the contact block or mounting adapter becomes unintentionally separated (in the case of panel-mounted contact blocks), the second contact opens, which always interrupts the same safety circuit.

When using the machine in this way, the operator can always identify any hidden faults that have occurred internally to the electrical enclosures.

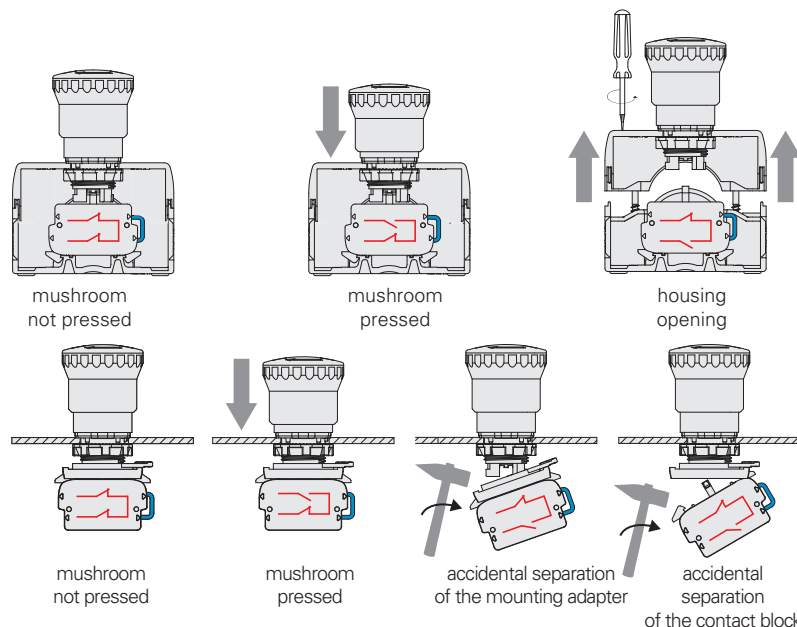

High-reliability self-cleaning contacts

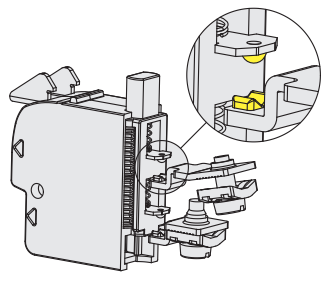

“V-shape” self-cleaning contacts with quadruple contact point. This type of shape, thanks to the presence of the double contact point, makes it possible to drastically reduce the probability of contact commutation failure. In addition to this, it improves considerably the reliability in the presence of dust.

Positive opening



All NC contacts are suitable for safety applications. The NC contacts are positive opening contacts acc. to IEC 60947-5-1.

Features approved by UL

Electrical ratings: A300 pilot duty (720 VA, 120-240 V ac)
Q300 pilot duty (69 VA, 125-250 V dc)

Note:
Use 60 or 75 °C copper (CU) conductor and wire size range 16-22 AWG, stranded or solid.
The terminal tightening torque of 7.1 Lb In (0.8 Nm).

Please contact our technical department for the list of approved products.

Features approved by IMQ

Rated insulation voltage (U_i): 250 V
Conventional free air thermal current (I_{th}): 10 A
Rated impulse withstand voltage (U_{imp}): 4 kV
Protection degree of the housing: IP20
Utilization category: AC-15
Operating voltage (U_e): 250 Vac (50/60 Hz)
Operating current (I_e): 6 A



Forms of the contact element: Y
Positive opening of contacts on contact blocks 01S
In compliance with standards: EN 60947-1, EN 60947-5-1, fundamental requirements of the Low Voltage Directive 2014/35/EU.

Please contact our technical department for the list of approved products.

Selection table for contact blocks

Packs of 5 pcs.



| Contact block | Panel mounting Screw connection |
|--|---|
| 1NC  slow action self-monitored | E2 CP01S2V1 2.3 1.1 0 1.1  2.1 5 |

The self-monitoring contact block with panel mounting can be installed on any position on the 3-slot mounting adapter, and in the two central positions only on the 4-slot mounting adapter.

| Contact block | Base mounting Screw connection |
|--|---|
| 1NC  slow action self-monitored | E2 CF01S2V1 2.3 1.1 0 1.1  2.1 5 |

The self-monitoring contact block with base mounting can be installed only in the central position under the device. The central position on the bottom of the housing is identified with number 3.

Complete units with contact block and mounting adapter



| Contacts | | | Panel mounting Screw connection |
|----------|--|--------|--|
| pos. 2 | pos. 3 | pos. 1 | |
| - | 1NC  SELF-MONITORED | - | E2 AC-XXBC0139 E2 1BAC11 + E2 CP01S2V1 |

Other combinations on request.

Installation of several single, double and self-monitored contact blocks

Always install self-monitored contact blocks directly on the mounting adapter.

Do not install self-monitored contact blocks on standard contact blocks. Forbidden application!

Per each emergency stop button no more than two self-monitored contact blocks can be installed.

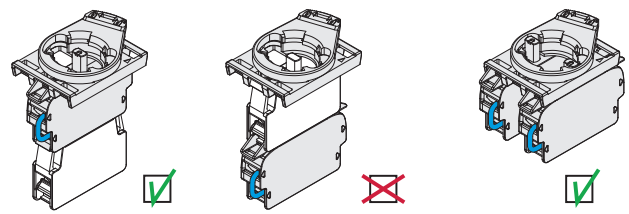

Dust protection

Packs of 50 pcs.

| Article | Description |
|---|---|
|  VE PR3A70 | Transparent dust protection for E2 series contact blocks. Suitable for all panel mounting contact blocks. |

→ The 2D and 3D files are available at www.pizzato.com

Dimensional drawings

All values in the drawings are in mm

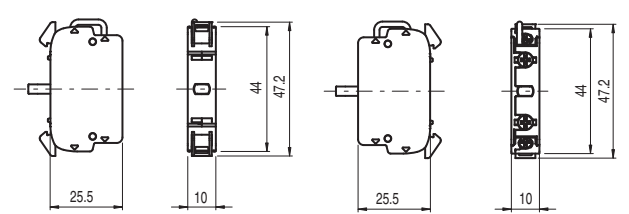

Selection diagram

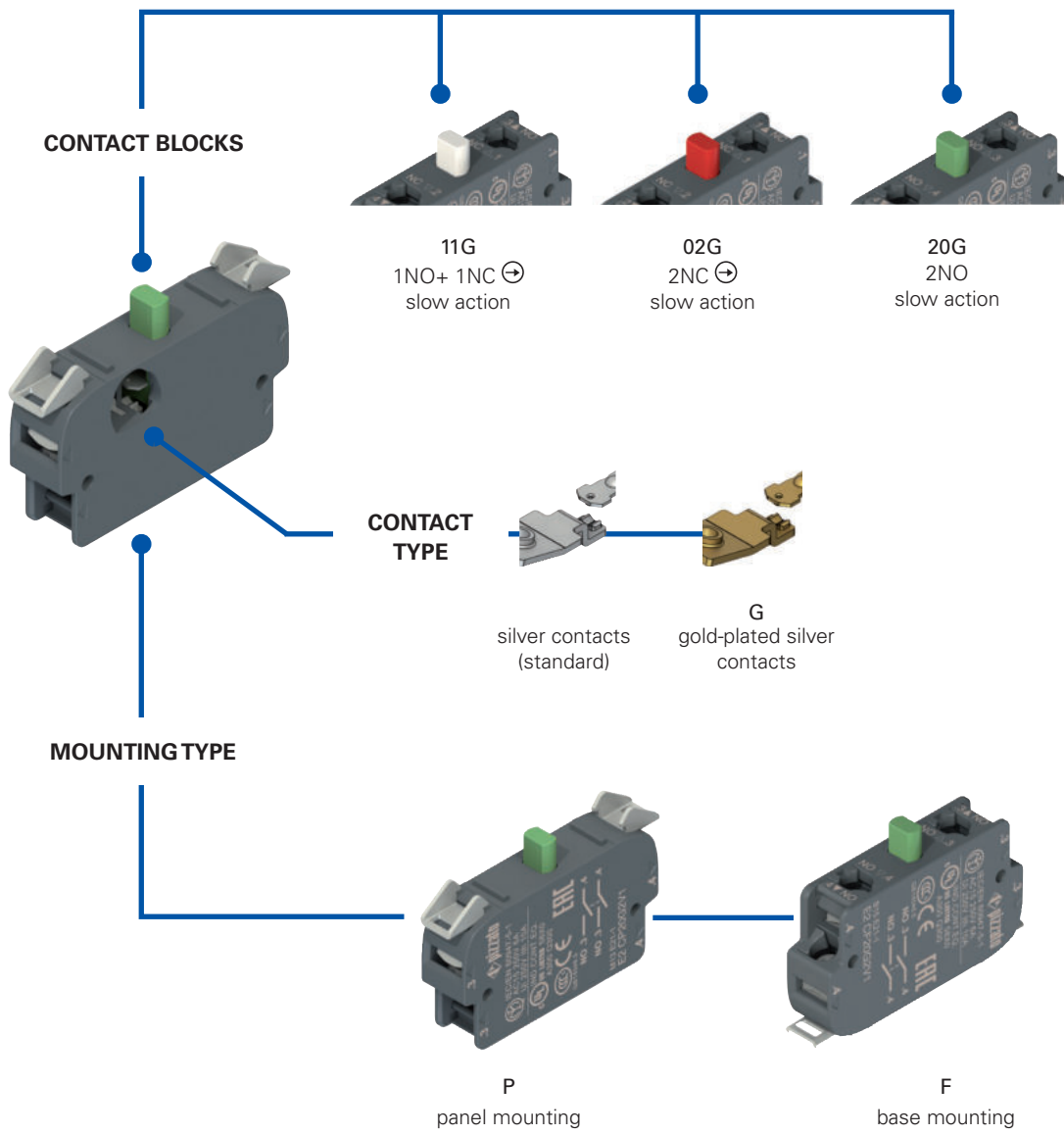

Code structure **Attention!** The feasibility of a code number does not mean the effective availability of a product. Please contact our sales office.

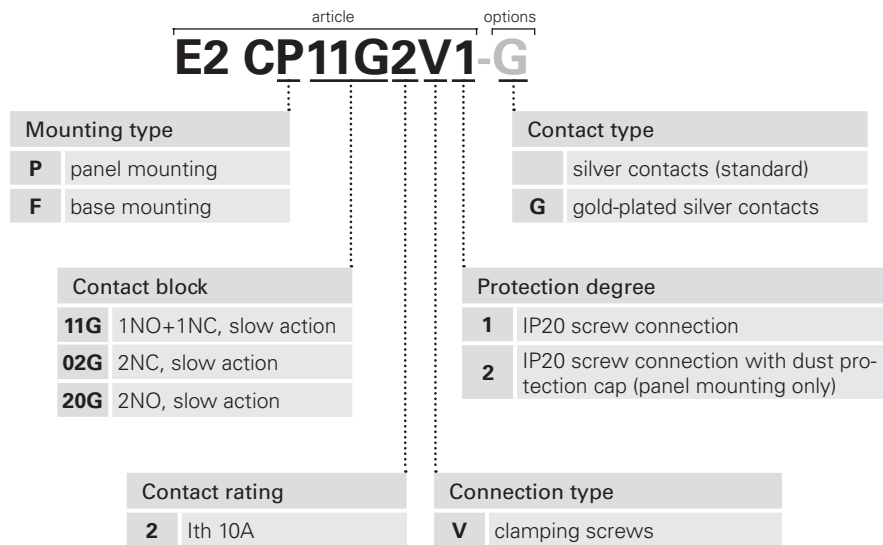

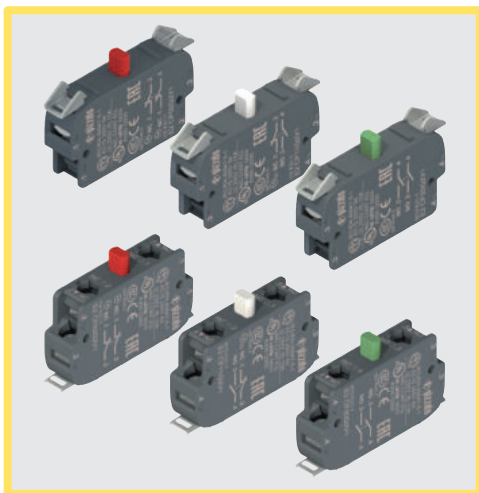

Main features

- Highly reliable contact blocks provided with self-cleaning contacts with quadruple contact point
- Versions with gold-plated contacts
- Positive opening NC contacts acc. to IEC 60947-5-1

Quality marks:



| | |
|---------------|-------------------------|
| IMO approval: | CA02.04805 |
| UL approval: | E131787 |
| CCC approval: | 2021000305000106 |
| EAC approval: | RU C-IT.YT03.B.00035/19 |

Technical data

General data

| | |
|---------------------------|--|
| Protection degree: | IP20 acc. to EN 60529 at the terminals |
| Ambient temperature: | -40°C ... +80°C |
| Mechanical endurance: | 20 million operating cycles |
| Max. actuation frequency: | 3600 operating cycles/hour |
| Utilization requirements: | see page 169 |

Contact block

| | |
|---|---|
| Switching force of the contacts: | 2NO: 1.7 N 2NC: 2 N 1NO+1NC: 2.7 N (NO) / 2.2 N (NC) |
| Actuating force at limit of travel: | 2NO: 3.8 N 2NC: 3.8 N 1NO+1NC: 4.5 N |
| Positive opening force: | 17 N |
| Actuation speed: | min 1 mm/s max. 0.5 m/s |
| Safety parameter B_{10D} : | 1,000,000 (NO), 40,000,000 (NC) |
| Material of the contacts: | Silver contacts (standard) For low current: standard silver contacts with 1 µm gold coating (on request) |
| Contact type: | "V-shape" self-cleaning contacts with quadruple contact point |
| Cable cross section: | min 1 x 0.34 mm ² (1 x AWG 22) max. 2 x 1.5 mm ² (2 x AWG 16) |
| Cable stripping length: | 7 mm |
| Tightening torque of the terminal screws: | 0.6 ... 0.8 Nm |

In compliance with standards:

IEC 60947-1, IEC 60947-5-1, IEC 60204-1, EN 60947-1, EN 60947-5-1, EN 60204-1, EN IEC 63000, UL 508, CSA C22.2 No. 14, GB/T14048.5.

⚠ Installation for safety applications:

Use only contact blocks marked with the symbol . The safety circuit must always be connected to **NC contacts** (normally closed contacts: .1-2)

Compliance with the requirements of:

Low Voltage Directive 2014/35/EU, EMC Directive 2014/30/EU, RoHS Directive 2011/65/EU.

Positive contact opening in conformity with standards:

IEC 60947-5-1, EN 60947-5-1.

Electrical data

| | |
|--|----------------------------|
| Thermal current (I_{th}): | 10 A |
| Rated insulation voltage (U_i): | 250 Vac/dc |
| Protection against short circuits: | type gG/gL fuse 10 A 500 V |
| Rated impulse withstand voltage (U_{imp}): | 4 kV |
| Pollution degree: | 3 |

Utilization category

| | | | | |
|--------------------------------------|-----|-----|-----|-----|
| Alternating current: AC15 (50±60 Hz) | | | | |
| U_e (V) | 24 | 48 | 120 | 250 |
| I_e (A) | 6 | 6 | 6 | 6 |
| Direct current: DC13 | | | | |
| U_e (V) | 24 | 48 | 125 | 250 |
| I_e (A) | 2.5 | 1.3 | 0.6 | 0.3 |

General data

Positive opening



All NC contacts are suitable for safety applications. The NC contacts are positive opening contacts acc. to IEC 60947-5-1.

High-reliability self-cleaning contacts

"V-shape" self-cleaning contacts with quadruple contact point. This type of shape, thanks to the presence of the double contact point, makes it possible to drastically reduce the probability of contact commutation failure. In addition to this, it improves considerably the reliability in the presence of dust.

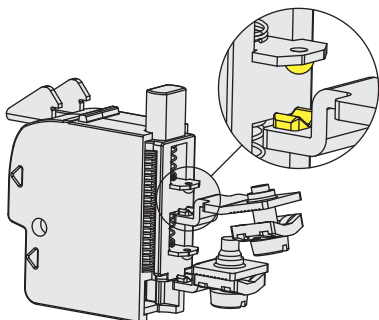

Modular design and compact dimensions

The double contact blocks of the EROUND series feature more compact dimensions compared to the other double contact blocks on the market.

Thanks to their compact dimensions, these versions can also be fixed on the base.

These double contact blocks have the same vertical dimensions of the single contact blocks of the EROUND series: this makes it possible to stack on more levels the single contact blocks with the double contact blocks and to interchange them during the assembly phase.

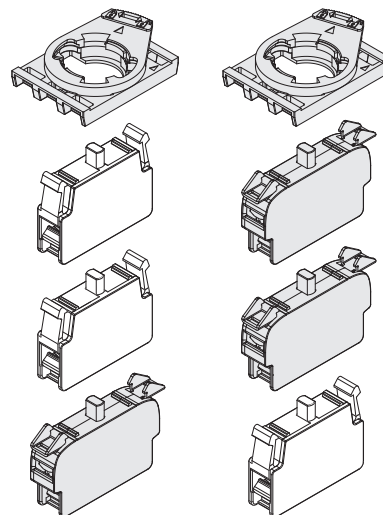

Features approved by UL

Electrical ratings: A300 pilot duty (720 VA, 120-240 V ac)
Q300 pilot duty (69 VA, 125-250 V dc)

Note:
Use 60 or 75 °C copper (CU) conductor and wire size range 16-22 AWG, stranded or solid.
The terminal tightening torque of 7.1 Lb In (0.8 Nm).

Please contact our technical department for the list of approved products.

Features approved by IMQ

Rated insulation voltage (U): 250 V
Conventional free air thermal current (I_{th}): 10 A
Rated impulse withstand voltage (U_{imp}): 4 kV
Protection degree of the housing: IP20
Utilization category: AC-15
Operating voltage (U_e): 250 Vac (50/60 Hz)
Operating current (I_e): 6 A





Forms of the contact element: Y+Y, X+X, Zb
Positive opening of contacts on contact blocks 11G, 02G
In compliance with standards: EN 60947-1, EN 60947-5-1, fundamental requirements of the Low Voltage Directive 2014/35/EU.

Please contact our technical department for the list of approved products.

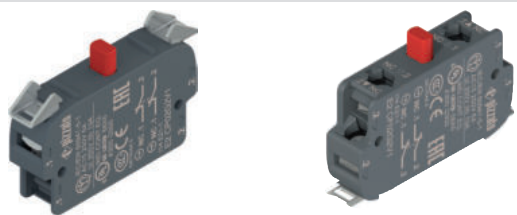
Selection table for contact blocks

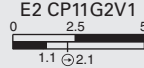
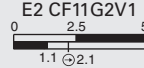

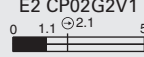
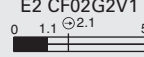

Packs of 5 pcs.



| Contact block | Panel mounting Screw connection | Base mounting Screw connection |
|--|--|--|
| 1NO+1NC, slow action  |  E2 CP11G2V1 |  E2 CF11G2V1 |
| 2NO, slow action  |  E2 CP20G2V1 |  E2 CF20G2V1 |
| 2NC, slow action  |  E2 CP02G2V1 |  E2 CF02G2V1 |

Complete units with contact block and mounting adapter



| Contacts | | | Panel mounting Screw connection | Contacts | | | Panel mounting Screw connection |
|----------|--|--------|---|--|--------|--|---|
| pos. 2 | pos. 3 | pos. 1 | | pos. 2 | pos. 3 | pos. 1 | |
| - | 1NO+ 1NC  | - | E2 AC-XXBC0135 E2 1BAC11 + E2 CP11G2V1 | 1NO+ 1NC  | - | 1NO+ 1NC  | E2 AC-XXBC0138 E2 1BAC11 + E2 CP11G2V1+ E2 CP11G2V1 |
| - | 2NO | - | E2 AC-XXBC0136 E2 1BAC11 + E2 CP20G2V1 | Other combinations on request. | | | |
| - | 2NC  | - | E2 AC-XXBC0137 E2 1BAC11 + E2 CP02G2V1 | | | | |

Other combinations on request.

Dimensional drawings

All values in the drawings are in mm

Contact block for panel mounting E2 CP••G•••

Contact block for base mounting E2 CF••G•••

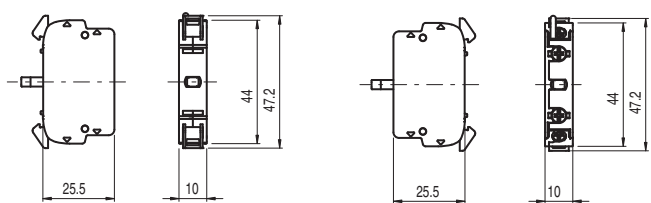

Dust protection

Packs of 50 pcs.

| Article | Description |
|-----------|---|
| VE PR3A70 | Transparent dust protection for E2 series contact blocks. Suitable for all panel mounting contact blocks. |

→ The 2D and 3D files are available at www.pizzato.com

Selection diagram

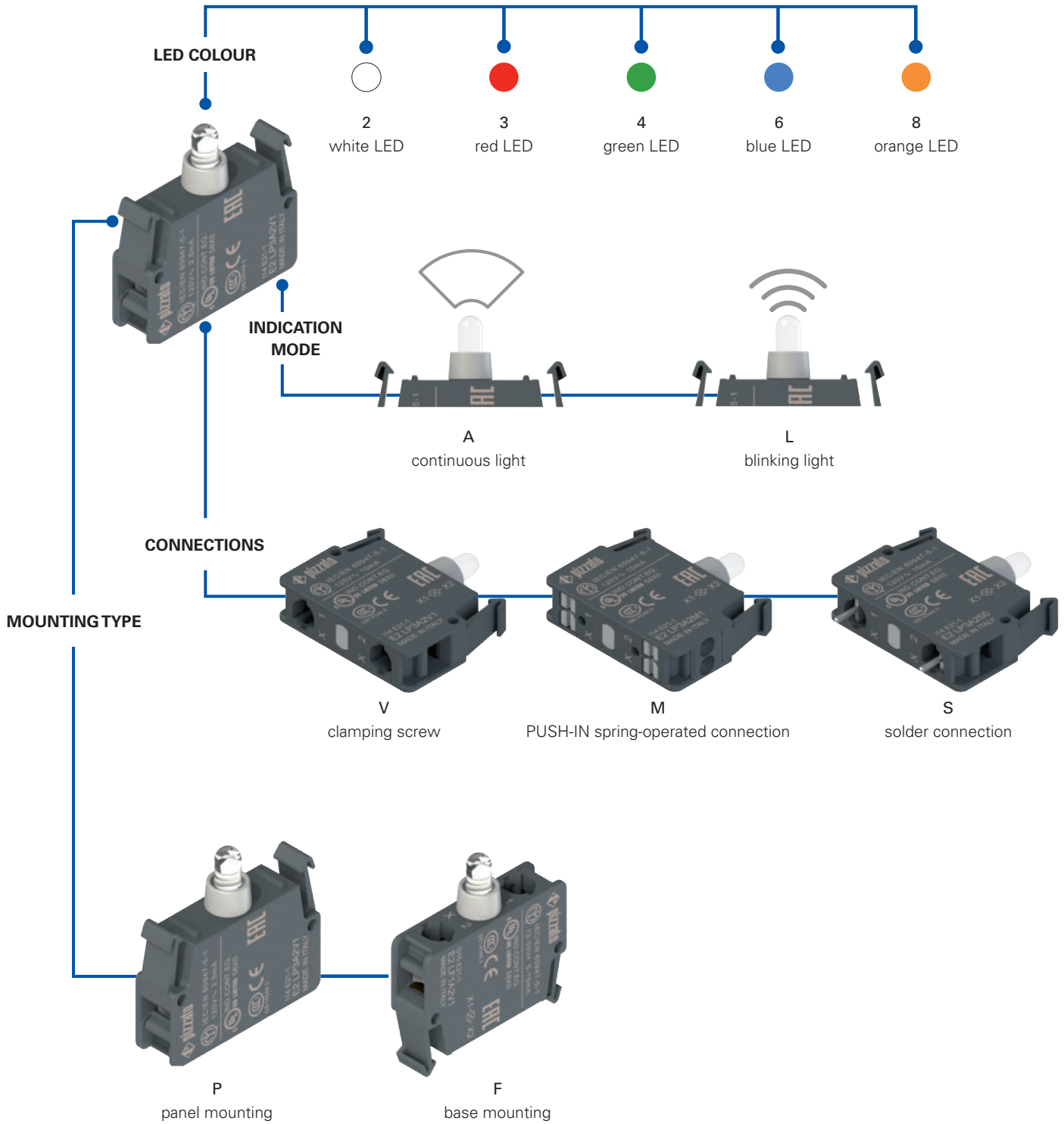

Code structure**Attention!** The feasibility of a code number does not mean the effective availability of a product. Please contact our sales office.

E2 LP1A3V1

| Mounting type | |
|---------------|----------------|
| P | panel mounting |
| F | base mounting |

| Protection degree | |
|-------------------|--|
| 0 | IP00 solder connection |
| 1 | IP20 screw connection and PUSH-IN spring-operated connection |

| Supply voltage | |
|----------------|------------------------------------|
| 1 | 12 ... 30 Vac/dc (high luminosity) |
| 3 | 120 Vac (high luminosity) |
| 4 | 230 Vac (high luminosity) |
| 7 | 120 Vac/dc (standard luminosity) |
| 8 | 230 Vac/dc (standard luminosity) |

| Connection type | |
|-----------------|---|
| V | clamping screw (standard) |
| M | PUSH-IN spring-operated connection |
| S | solder connection (panel mounting only) |

| Indication mode | |
|-----------------|--|
| A | Continuous light (standard) |
| L | blinking light (only with 12 ... 30 V supply voltage) |

| LED colour | |
|------------|--------|
| 2 | white |
| 3 | red |
| 4 | green |
| 6 | blue |
| 8 | orange |

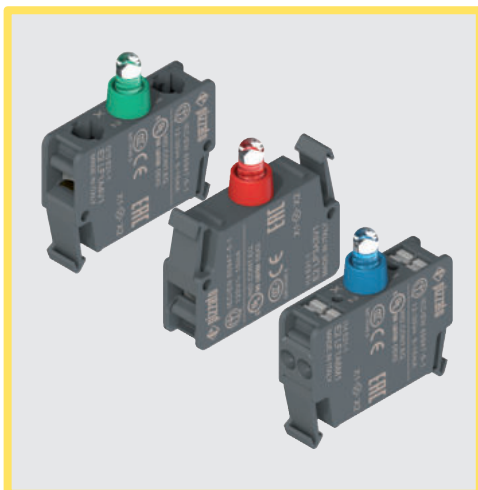

Main features

- High luminosity LED
- Three supply voltages:
12 ... 30 Vac/dc, 120 Vac, 230 Vac
- Screw, PUSH-IN spring, or solder connections
- Continuous or blinking light
- Panel or base mounting versions

Quality marks:



| | |
|---------------|-------------------------|
| IMO approval: | CA02.04806 |
| UL approval: | E131787 |
| CCC approval: | 2021000305000106 |
| EAC approval: | RU C-IT.YT03.B.00035/19 |

Technical data

General data

| | |
|-------------------------------------|---|
| Protection degree acc. to EN 60529: | IP20 with screw connection IP20 with PUSH-IN spring-operated connection IP00 with solder connection |
| Ambient temperature: | -25°C ... +70°C |
| Endurance: | 100,000 hours (at rated voltage and +25°C ambient temperature) |
| Utilization requirements: | see page 169 |

LED unit

| | |
|---|---|
| Operating voltages and currents (high luminosity versions): | 12 ... 30 Vac/dc; 5 ... 20 mA 102 ... 138 Vac; 20 mA max. 195 ... 264 Vac; 20 mA max. |
| Operating voltages and currents (standard luminosity versions): | 102 ... 138 Vac/dc; 2.5 mA 195 ... 264 Vac/dc; 2.5 mA |
| Blinking frequency: | 1 Hz |

Clamping screw connection

| | |
|-----------------------------|--|
| Cable cross section: | min 1 x 0.5 mm ² (1 x AWG 20) max 2 x 2.5 mm ² (2 x AWG 14) |
| Tightening torque: | 0.6 ... 0.8 Nm |
| Cable stripping length (x): | 8 mm |

PUSH-IN spring-operated connection

| | |
|---|---|
| Cable cross section (flexible conductors, with or without wire-end sleeve): | min. 1 x 0.25 mm ² (1 x AWG 24) max. 2 x 1.5 mm ² (1 x AWG 16) |
| Cable stripping length (x): | min. 8 mm, max. 10 mm |



In compliance with standards:

IEC 60947-1, IEC 60947-5-1, IEC 60204-1, EN 60947-1, EN 60947-5-1, EN 60204-1, EN IEC 63000, UL 508, CSA C22.2 No. 14, GB/T14048.5.

Compliance with the requirements of:

Low Voltage Directive 2014/35/EU,
EMC Directive 2014/30/EU,
RoHS Directive 2011/65/EU.

Features approved by UL

Electrical ratings:
12-30 V ac/dc, 5-20 mA
120 V ac, 20 mA max
230 V ac, 20 mA max
120 V ac/dc, 2.5 mA
230 V ac/dc, 2.5 mA

Note:

For LED holder series E2 L provided with clamping screw terminals: use 60 or 75 °C copper (Cu) conductor and wire size range 14-20 AWG, stranded or solid. The terminal tightening torque of 7.1 Lb In (0.8 Nm).

For LED holder series E2 L provided with screw less type terminals: use 60 or 75 °C copper (Cu) conductor and wire size range 16-24 AWG, stranded. These terminals are suitable also for stranded conductors prepared with ZMLF ferrules. Recommended stripping length: 8 mm.

Please contact our technical department for the list of approved products.

Features approved by IMO

Rated insulation voltage (Ui): 500 V
Indicator light type: Incorporated LED
Terminals: screw terminals, terminals without screw, solder terminals
Rated operating voltage (Ue):
12 ... 30 Vac/dc (5 ... 20 mA), 120 Vac (20 mA), 230 Vac (20 mA)
120 Vac/dc (2.5 mA), 230 Vac/dc (2.5 mA)

In compliance with standards: EN 60947-1, EN 60947-5-1, fundamental requirements of the Low Voltage Directive 2014/35/EU.

Please contact our technical department for the list of approved products.

General data

Continuous or blinking light



The LED units can be provided with two different lighting types: continuous or blinking light. The blinking light versions allow a faster identification on the panel of the lit device compared to the continuous light. The special internal electronic circuit autonomously alternates the ON and OFF phases without requiring any special electrical connection.

Screw connection with clamping screw plates

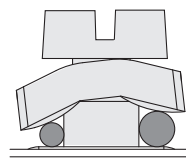

The clamping screw plates of the LED units are provided with a particular "roofing tile" structure and are loosely coupled to the clamping screw. This way, during the wires fixing, the clamping screw plate is able to suit to cables of different diameters and tends to tighten the wires toward the screw instead of permitting them to escape towards the outside.

PUSH-IN spring-operated connection



The PUSH-IN spring connection allows quick and simple wiring, as the wire just needs to be inserted into the appropriate hole in order to establish the electrical connection and automatically secure the wire. The reduced force required to insert the wire allows completely tool-free connection by using wires with crimped wire-end sleeves. They are released by pressing a special wire release button - including individually - with any tool, without the need to use a screwdriver of a predefined size. In addition, the contact block has holes for insertion of tester tips, so that electrical measurements can be carried out, without having to remove the connecting cables.

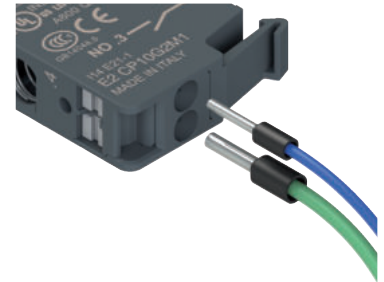

Solder connection on printed circuit

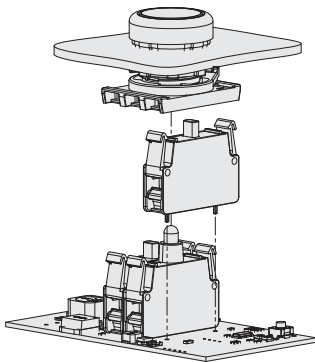

Versions with panel mounting of the EROUND series LED units with solder pin are available. If there is no wiring but a printed circuit, these LED units can be directly welded on the latter.

Available versions

The LED units of the signalling and control devices are available with two types of coupling: panel mounting and base mounting.

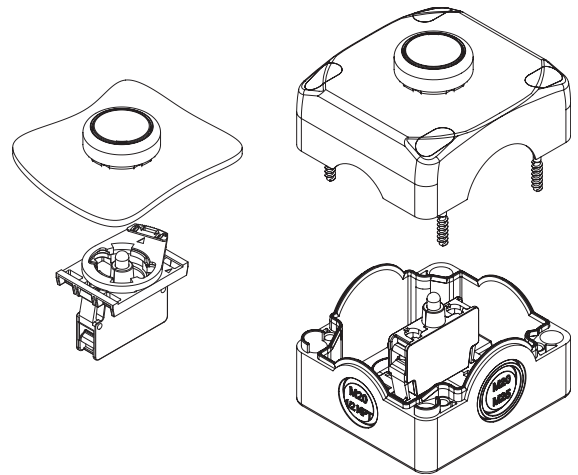

High luminosity LED

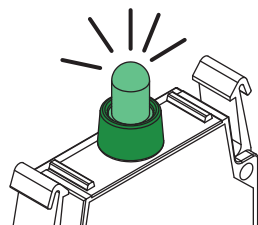

The LED units to combine with the luminous devices feature a high-intensity LED, which ensures greater visibility. The use of an integrated LED gives greater benefits compared to incandescence lamps because they last longer and absorb less power than the latter. LEDs feature greater reliability, low consumption, and high resistance to vibrations.

Immediate recognition of the colour

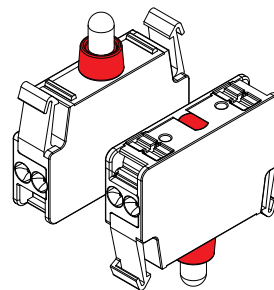

The unit has a coloured plastic ring that extends from the led bulb to the bottom of the unit. Thanks to this device, recognising the LED colour is easier and more immediate even in those situations where the LED is not directly visible (for example: in panel mounting) or when there are many units side by side. Unlike other solutions on the market, it is not necessary to look for markings on the body of the item.

Selection table for LED units

Packs of 5 pcs.



| LED colour | Available device colour | Panel mounting | | | | | | | | |
|------------|-------------------------|-------------------|------------|------------|------------------------------------|------------|------------|-------------------|------------|------------|
| | | Screw connection | | | PUSH-IN spring-operated connection | | | Solder connection | | |
| | | Operating voltage | | | | | | | | |
| | | 12 ... 30 Vac/dc | 120 Vac | 230 Vac | 12 ... 30 Vac/dc | 120 Vac | 230 Vac | 12 ... 30 Vac/dc | 120 Vac | 230 Vac |
| white | white / yellow | E2 LP1A2V1 | E2 LP3A2V1 | E2 LP4A2V1 | E2 LP1A2M1 | E2 LP3A2M1 | E2 LP4A2M1 | E2 LP1A2S0 | E2 LP3A2S0 | E2 LP4A2S0 |
| red | red | E2 LP1A3V1 | E2 LP3A3V1 | E2 LP4A3V1 | E2 LP1A3M1 | E2 LP3A3M1 | E2 LP4A3M1 | E2 LP1A3S0 | E2 LP3A3S0 | E2 LP4A3S0 |
| green | green | E2 LP1A4V1 | E2 LP3A4V1 | E2 LP4A4V1 | E2 LP1A4M1 | E2 LP3A4M1 | E2 LP4A4M1 | E2 LP1A4S0 | E2 LP3A4S0 | E2 LP4A4S0 |
| blue | blue | E2 LP1A6V1 | E2 LP3A6V1 | E2 LP4A6V1 | E2 LP1A6M1 | E2 LP3A6M1 | E2 LP4A6M1 | E2 LP1A6S0 | E2 LP3A6S0 | E2 LP4A6S0 |
| orange | orange | E2 LP1A8V1 | E2 LP3A8V1 | E2 LP4A8V1 | E2 LP1A8M1 | E2 LP3A8M1 | E2 LP4A8M1 | E2 LP1A8S0 | E2 LP3A8S0 | E2 LP4A8S0 |

We recommend to match the colours of the LEDs to the colours of the devices.







| LED colour | Available device colour | Base mounting | | | | | |
|------------|-------------------------|-------------------|------------|------------|------------------------------------|------------|------------|
| | | Screw connection | | | PUSH-IN spring-operated connection | | |
| | | Operating voltage | | | | | |
| | | 12 ... 30 Vac/dc | 120 Vac | 230 Vac | 12 ... 30 Vac/dc | 120 Vac | 230 Vac |
| white | white / yellow | E2 LF1A2V1 | E2 LF3A2V1 | E2 LF4A2V1 | E2 LF1A2M1 | E2 LF3A2M1 | E2 LF4A2M1 |
| red | red | E2 LF1A3V1 | E2 LF3A3V1 | E2 LF4A3V1 | E2 LF1A3M1 | E2 LF3A3M1 | E2 LF4A3M1 |
| green | green | E2 LF1A4V1 | E2 LF3A4V1 | E2 LF4A4V1 | E2 LF1A4M1 | E2 LF3A4M1 | E2 LF4A4M1 |
| blue | blue | E2 LF1A6V1 | E2 LF3A6V1 | E2 LF4A6V1 | E2 LF1A6M1 | E2 LF3A6M1 | E2 LF4A6M1 |
| orange | orange | E2 LF1A8V1 | E2 LF3A8V1 | E2 LF4A8V1 | E2 LF1A8M1 | E2 LF3A8M1 | E2 LF4A8M1 |





We recommend to match the colours of the LEDs to the colours of the devices.

Complete units with LED unit, contact block and mounting adapter







| LED colour | Contacts | | | Panel mounting | |
|--|----------|--------|--------|---|--|
| | pos. 2 | pos. 3 | pos. 1 | Operating voltage 12 ... 30 Vac/dc | |
|  white | 1NC ⊕ | LED | - | E2 AC-XXBC0020 E2 1BAC11 + E2 CP01G2V1 + E2 LP1A2V1 | |
|  red | 1NC ⊕ | LED | - | E2 AC-XXBC0037 E2 1BAC11 + E2 CP01G2V1 + E2 LP1A3V1 | |
|  green | 1NC ⊕ | LED | - | E2 AC-XXBC0029 E2 1BAC11 + E2 CP01G2V1 + E2 LP1A4V1 | |
|  blue | 1NC ⊕ | LED | - | E2 AC-XXBC0045 E2 1BAC11 + E2 CP01G2V1 + E2 LP1A6V1 | |
|  orange | 1NC ⊕ | LED | - | E2 AC-XXBC0058 E2 1BAC11 + E2 CP01G2V1 + E2 LP1A8V1 | |

Other combinations on request.





| LED colour | Contacts | | | Panel mounting | |
|--|----------|--------|--------|---|--|
| | pos. 2 | pos. 3 | pos. 1 | Operating voltage 12 ... 30 Vac/dc | |
|  white | - | LED | 1NO | E2 AC-XXBC0021 E2 1BAC11 + E2 LP1A2V1 + E2 CP10G2V1 | |
|  red | - | LED | 1NO | E2 AC-XXBC0039 E2 1BAC11 + E2 LP1A3V1 + E2 CP10G2V1 | |
|  green | - | LED | 1NO | E2 AC-XXBC0031 E2 1BAC11 + E2 LP1A4V1 + E2 CP10G2V1 | |
|  blue | - | LED | 1NO | E2 AC-XXBC0047 E2 1BAC11 + E2 LP1A6V1 + E2 CP10G2V1 | |
|  orange | - | LED | 1NO | E2 AC-XXBC0059 E2 1BAC11 + E2 LP1A8V1 + E2 CP10G2V1 | |

Other combinations on request.



| LED colour | Contacts | | | Panel mounting | |
|--|----------|--------|--------|---|--|
| | pos. 2 | pos. 3 | pos. 1 | Operating voltage 12 ... 30 Vac/dc | |
|  white | 1NC ⊕ | LED | 1NO | E2 AC-XXBC0027 E2 1BAC11 + E2 CP01G2V1 + E2 LP1A2V1 + E2 CP10G2V1 | |
|  red | 1NC ⊕ | LED | 1NO | E2 AC-XXBC0044 E2 1BAC11 + E2 CP01G2V1 + E2 LP1A3V1 + E2 CP10G2V1 | |
|  green | 1NC ⊕ | LED | 1NO | E2 AC-XXBC0036 E2 1BAC11 + E2 CP01G2V1 + E2 LP1A4V1 + E2 CP10G2V1 | |
|  blue | 1NC ⊕ | LED | 1NO | E2 AC-XXBC0052 E2 1BAC11 + E2 CP01G2V1 + E2 LP1A6V1 + E2 CP10G2V1 | |
|  orange | 1NC ⊕ | LED | 1NO | E2 AC-XXBC0060 E2 1BAC11 + E2 CP01G2V1 + E2 LP1A8V1 + E2 CP10G2V1 | |

Other combinations on request.

| LED colour | Contacts | | | Panel mounting | |
|--|----------|--------|--------|---|--|
| | pos. 2 | pos. 3 | pos. 1 | Operating voltage 12 ... 30 Vac/dc | |
|  white | - | LED | - | E2 AC-XXBC0053 E2 1BAC11 + E2 LP1A2V1 | |
|  red | - | LED | - | E2 AC-XXBC0055 E2 1BAC11 + E2 LP1A3V1 | |
|  green | - | LED | - | E2 AC-XXBC0054 E2 1BAC11 + E2 LP1A4V1 | |
|  blue | - | LED | - | E2 AC-XXBC0056 E2 1BAC11 + E2 LP1A6V1 | |
|  orange | - | LED | - | E2 AC-XXBC0057 E2 1BAC11 + E2 LP1A8V1 | |

Other combinations on request.

Dimensional drawings All values in the drawings are in mm

LED unit for panel mounting with screw connection, PUSH-IN spring-operated connection

LED unit for base mounting with screw connection, PUSH-IN spring-operated connection

LED unit for panel mounting with solder connection

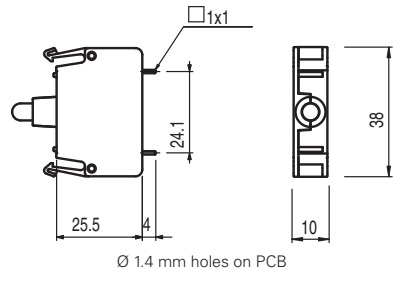
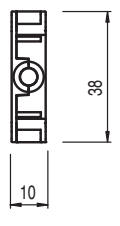
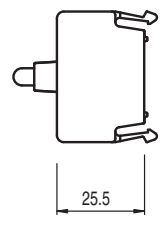
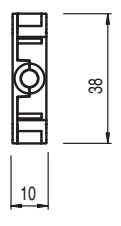
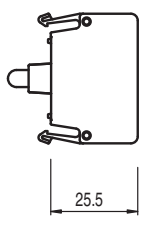

→ The 2D and 3D files are available at www.pizzato.com

Selection diagram

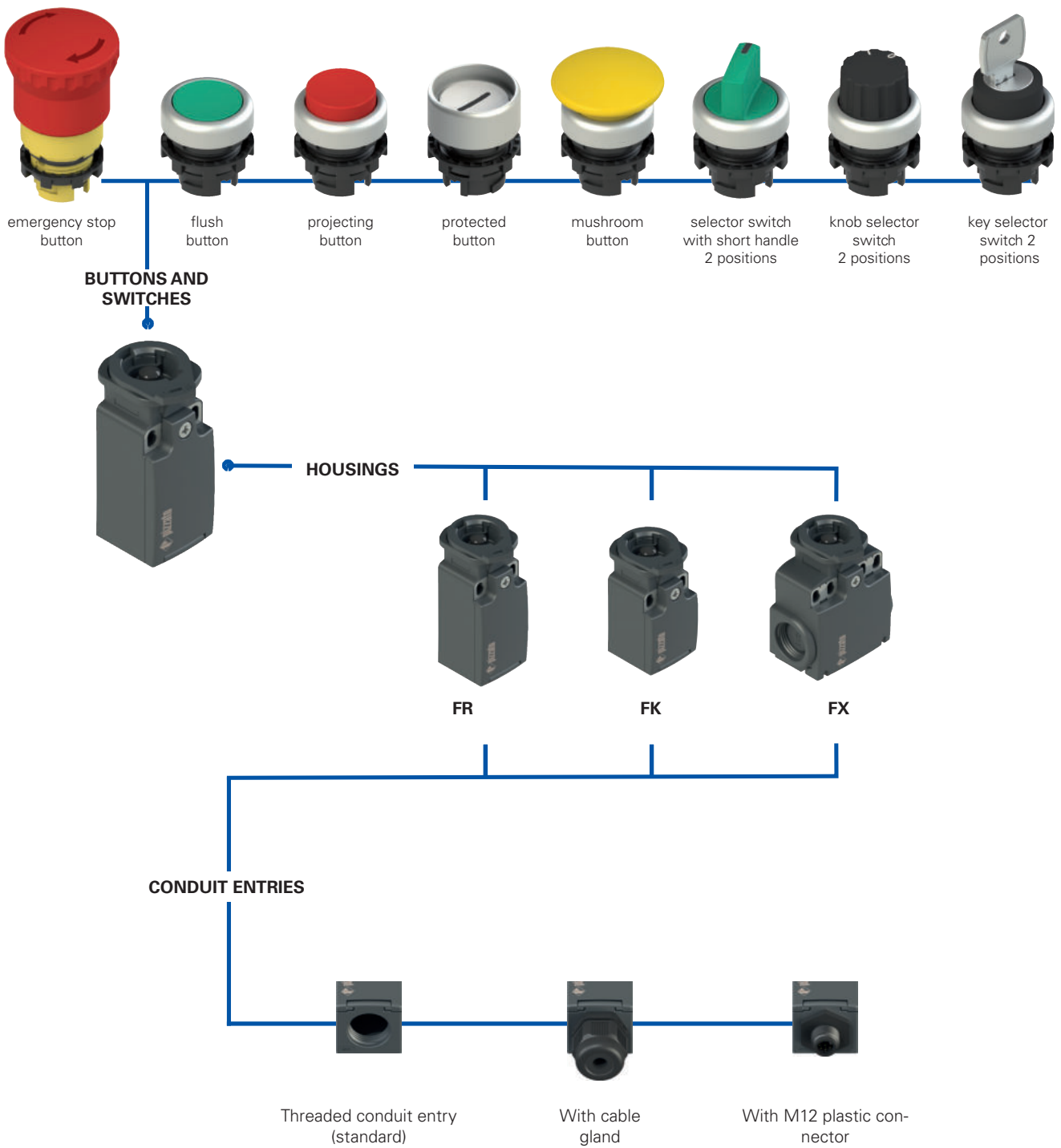

Code structure **Attention!** The feasibility of a code number does not mean the effective availability of a product. Please contact our sales office.

article
option
option
FR 6E2-GM2K23T6

| Housing | |
|-----------|------------------------------------|
| FR | technopolymer, one conduit entry |
| FX | technopolymer, two conduit entries |

| Ambient temperature | |
|---------------------|----------------------------|
| | -25°C ... +80°C (standard) |
| T6 | -40°C ... +80°C |

| Contact block | |
|---------------|----------------------|
| 6 | 1NO+1NC, slow action |
| 9 | 2NC, slow action |
| 20 | 1NO+2NC, slow action |

| Pre-installed cable glands or connectors | |
|--|--|
| | no cable gland or connector (standard) |
| K23 | cable gland for cables Ø 6 ... 12 mm |
| ... | ... |
| K70 | M12 plastic connector, 4-pole |
| ... | ... |

| Contact type | |
|--------------|---|
| | silver contacts (standard) |
| G | silver contacts with 1 µm gold coating |
| G1 | silver contacts with 2.5 µm gold plating (not for contact block 20) |

For the complete list of possible combinations please contact our technical department.

| Threaded conduit entry | |
|------------------------|---------|
| M2 | M20x1.5 |

article
option
option
FK 33E2-GM1K24T6

| Housing | |
|-----------|----------------------------------|
| FK | technopolymer, one conduit entry |

| Ambient temperature | |
|---------------------|----------------------------|
| | -25°C ... +80°C (standard) |
| T6 | -40°C ... +80°C |

| Contact block | |
|---------------|----------------------|
| 33 | 1NO+1NC, slow action |
| 34 | 2NC, slow action |

| Pre-installed cable glands | |
|----------------------------|--------------------------------------|
| | no cable gland (standard) |
| K24 | cable gland for cables Ø 5 ... 10 mm |
| K28 | cable gland for cables Ø 3 ... 7 mm |

| Contact type | |
|--------------|--|
| | silver contacts (standard) |
| G | silver contacts with 1 µm gold coating |

| Threaded conduit entry | |
|------------------------|---------|
| M1 | M16x1.5 |



Main features

- Protection degree IP67
- Technopolymer housing
- Versions with gold-plated silver contacts

Quality marks:



| | |
|---------------|-------------------------|
| IMQ approval: | EG610 |
| UL approval: | E131787 |
| CCC approval: | 2021000305000101 |
| EAC approval: | RU C-IT.YT03.B.00035/19 |

Compliance with the requirements of:

Low Voltage Directive 2014/35/EU,
EMC Directive 2014/30/EU,
RoHS Directive 2011/65/EU.

Positive contact opening in conformity with standards:

IEC 60947-5-1, EN 60947-5-1.

Technical data

General data

| | |
|--|---|
| Housing made of glass fibre reinforced technopolymer, self-extinguishing, shock-proof and with double insulation | ☐ |
| FR series, one conduit entry: | M20x1.5 |
| FK series: one threaded conduit entry: | M16x1.5 |
| FX series, two knock-out threaded conduit entries: | M20x1.5 |
| Protection degree: | IP67 acc. to EN 60529 with cable gland of equal or higher protection degree |
| Ambient temperature: | -25°C ... +80°C (standard) -40°C ... +80°C (T6 option) |
| Safety parameter B_{10D} : | 40,000,000 |
| Max. actuation frequency: | 3600 operating cycles/hour |
| Mechanical endurance: | 20 million operating cycles |
| Utilization requirements: | see page 169 |

Contact block

Switching force, FR, FX series contacts

| | |
|----------|-------------------------|
| 1NO+1NC: | 3.3 N (NC) / 6 N (NO) |
| 2NC: | 6.5 N |
| 1NO+2NC: | 5.8 N (NC) / 6.5 N (NO) |

Switching force, FK series contacts

| | |
|----------|-------------------------|
| 1NO+1NC: | 4.5 N (NC) / 5.3 N (NO) |
| 2NC: | 4.4 N |

FR, FX series limit of travel force

| | |
|----------|--------|
| 1NO+1NC: | 9 N |
| 2NC: | 8.5 N |
| 1NO+2NC: | 10.3 N |

FK series limit of travel force

| | |
|----------|-------|
| 1NO+1NC: | 9.3 N |
| 2NC: | 8 N |

Positive opening force

25 N

Actuation speed

min 1 mm/s

max. 0.5 m/s

Material of the contacts:

Normal: silver contacts (standard)

Low current: silver contacts with gold plating (on request)

Cable cross section (flexible copper strands)

Contact blocks 20, 33, 34:

min. 1 x 0.34 mm² (1 x AWG 22)

max. 2 x 1.5 mm² (2 x AWG 16)

Contact blocks 6, 9:

min. 1 x 0.5 mm² (1 x AWG 20)

max. 2 x 2.5 mm² (2 x AWG 14)

Cable stripping length:

7 mm for contact blocks 20, 33, 34

8 mm for contact blocks 6, 9

Tightening torque of the terminal screws:

0.6 ... 0.8 Nm

Wiring diagrams of the assembled connectors: see page 194

In compliance with standards:

IEC 60947-5-1, EN 60947-5-1, EN 60947-1, EN 50047, IEC 60204-1, EN 60204-1, EN ISO 14119, EN ISO 12100, IEC 60529, EN 60529, EN IEC 63000, UL 508, CSA C22.2 No. 14, GB/T14048.5.

⚠ Installation for safety applications:

Use only contact blocks marked with the symbol . The safety circuit must always be connected to **NC contacts** (normally closed contacts: 11-12, 21-22 or 31-32).

Electrical data

Utilization category

| | | | | | | |
|-------------------|--|---|--------------------------------------|-----|------|-----|
| without connector | Thermal current (I_{th}): | 10 A | Alternating current: AC15 (50÷60 Hz) | | | |
| | Rated insulation voltage (U_i): | 500 Vac 600 Vdc | Ue (V) | 250 | 400 | 500 |
| | | 400 Vac 500 Vdc (contact blocks 20, 33, 34) | Ie (A) | 6 | 4 | 1 |
| | Rated impulse withstand voltage (U_{imp}): | 6 kV / 4 kV (contact blocks 20, 33, 34) | Direct current: DC13 | | | |
| | Conditional short circuit current: | 1000 A acc. to EN 60947-5-1 | Ue (V) | 24 | 125 | 250 |
| | Protection against short circuits: | type aM fuse 10 A 500 V | Ie (A) | 3 | 0.55 | 0.3 |
| Pollution degree: | 3 | | | | | |

| | | | | | | |
|----------------------------|-------------------------------------|------------------------------------|--------------------------------------|--------|------|-----|
| with M12 connector, 4-pole | Thermal current (I_{th}): | 4 A | Alternating current: AC15 (50÷60 Hz) | | | |
| | Rated insulation voltage (U_i): | 250 Vac 300 Vdc | Ue (V) | 24 | 120 | 250 |
| | | Protection against short circuits: | type gG fuse 4 A 500 V | Ie (A) | 4 | 4 |
| | Pollution degree: | 3 | Direct current: DC13 | | | |
| | | | Ue (V) | 24 | 125 | 250 |
| | | | Ie (A) | 3 | 0.55 | 0.3 |

| | | | | | | |
|----------------------------|-------------------------------------|------------------------------------|--------------------------------------|--------|---|--|
| with M12 connector, 8-pole | Thermal current (I_{th}): | 2 A | Alternating current: AC15 (50÷60 Hz) | | | |
| | Rated insulation voltage (U_i): | 30 Vac 36 Vdc | Ue (V) | 24 | | |
| | | Protection against short circuits: | type gG fuse 2 A 500 V | Ie (A) | 2 | |
| | Pollution degree: | 3 | Direct current: DC13 | | | |
| | | | Ue (V) | 24 | | |
| | | | Ie (A) | 2 | | |

Features approved by UL

Electrical ratings: Q300 (69 VA, 125-250 Vdc)
A600 (720 VA, 120-600 Vac)
Housing features type 1, 4X "indoor use only", 12, 13.
For all contact blocks except 2 and 3 use 60 or 75 °C copper (Cu) conductors, rigid or flexible, wire size 12, 14 AWG. Tightening torque for terminal screws of 7.1 lb in (0.8 Nm).
For contact blocks 2 and 3 use 60 or 75 °C copper (Cu) conductors, rigid or flexible, wire size 14 AWG. Tightening torque for terminal screws of 12 lb in (1.4 Nm).
In compliance with standard: UL 508, CSA 22.2 No.14

Please contact our technical department for the list of approved products.

Features approved by IMQ

Rated insulation voltage (U_i): 500 Vac
400 Vac (for contact blocks 20, 33, 34)
Conventional free air thermal current (I_{th}): 10 A
Protection against short circuits: type aM fuse 10 A 500 V
Rated impulse withstand voltage (U_{imp}): 6 kV
4 kV (for contact blocks 20, 33, 34)
Protection degree of the housing: IP67
MV terminals (screw terminals)
Pollution degree: 3
Utilization category: AC15
Operating voltage (U_e): 400 Vac (50 Hz)
Operating current (I_e): 3 A
Forms of the contact element: Za, Zb, Za+Za, Y+Y, X+X, Y+Y+X, Y+Y+Y, Y+X+X
Positive opening of contacts on contact blocks 6, 9, 20, 33, 34
In compliance with standards: EN 60947-1, EN 60947-5-1, fundamental requirements of the Low Voltage Directive 2014/35/EU.

Please contact our technical department for the list of approved products.

Description



The protected contact block makes it possible to achieve an IP67 protection degree also in the contact area. This is essential if there is dust inside the panel (for example, in equipment used in the timber sector).
The buttons, the 2-position selectors and the emergency stop buttons of the EROUND series can be used as normal actuators in the FR, FK, and FX protected contact blocks.

Applications



Protected contact block for control devices fitted in switching cabinets with the presence of dust also inside the cabinet. The block ensures an IP67 protection degree for internal electric contacts.

Extended temperature range

-40°C These devices are also available in a special version suitable for an ambient operating temperature range from -40°C up to +80°C.
They can therefore be used for applications in cold stores, sterilisers and other equipment with low temperature environments. The special materials used to produce these versions retain their characteristics even under these conditions, thereby expanding the installation possibilities.

Contact blocks



Contact blocks with captive screws, finger protection, twin bridge contacts and double interruption for higher contact reliability. They are available in multiple variants with shifted activation travels, simultaneous or overlapping. They are suitable for many different applications.

Protection degree IP67

IP67 These devices are designed to be used under the toughest environmental conditions, and they pass the IP67 immersion test acc. to EN 60529. They can therefore be used in all environments where the maximum degree of protection is required for the housing.

Gold-plated contacts

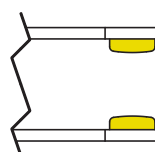

The contact blocks of these devices can be supplied gold-plated upon request. Ideal for applications with low voltages or currents; it ensures increased contact reliability. Available in two thicknesses (1 or 2.5 microns), it adapts perfectly to the various fields of application, ensuring a long endurance over time.

Selection table for contact blocks



| Contact block | Article |
|------------------------------------|----------------|
| 1NO+1NC, slow action \rightarrow | FR 6E2-M2 |
| 2NC, slow action \rightarrow | FR 9E2-M2 |
| 1NO+2NC, slow action \rightarrow | FR 20E2-M2 |



| Contact block | Article |
|------------------------------------|----------------|
| 1NO+1NC, slow action \rightarrow | FX 6E2-M2 |
| 2NC, slow action \rightarrow | FX 9E2-M2 |
| 1NO+2NC, slow action \rightarrow | FX 20E2-M2 |



| Contact block | Article |
|------------------------------------|----------------|
| 1NO+1NC, slow action \rightarrow | FK 33E2-M1 |
| 2NC, slow action \rightarrow | FK 34E2-M1 |

Dimensional drawings

All values in the drawings are in mm

FR series

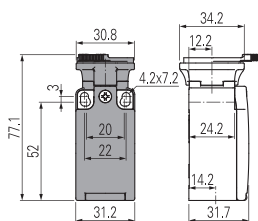

FX series

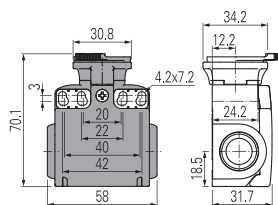

FK series

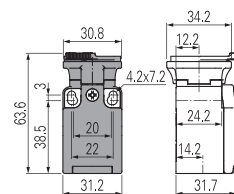

\rightarrow The 2D and 3D files are available at www.pizzato.com

Limits of use

The protected contact block protects exclusively the electric contacts from fine dust or water coming from the switching cabinet.

The protected contact block can be combined only with following devices:

- E2 •PU••••• buttons
- E2 •PE••••• emergency stop buttons
- E2 •SE•2••••• two-position selector switches
- E2 •SC2••••• two-position key selector switches.

The protected contact block must be wired before the coupling with its actuator.

After the wiring, excessive traction on the cable or impacts on the housing can cause the detachment of the contact block from the actuator.

Do not use in environments with presence of explosive or flammable gas. In these cases, use ATEX products (see dedicated Pizzato catalogue).

Selection diagram



Code structure

Attention! The feasibility of a code number does not mean the effective availability of a product. Please contact our sales office.

E2 1USB9CAK

| Fixing ring and shaped ring | |
|-----------------------------|-------------------------------------|
| 1 | plastic fixing ring (standard) |
| 2 | plastic fixing ring and shaped ring |
| 3 | metal fixing ring |
| 4 | metal fixing ring and shaped ring |

| External bezel colour | |
|-----------------------|-------------------------|
| 1 | black (standard) |
| 9 | satin chrome (standard) |

| Rear connection | |
|-----------------|---|
| AK | A-type USB integrated socket |
| N0.8 | Output with PVC cable (length 0.8 m) and A-type USB male connector |
| N1.8 | Output with PVC cable (length 1.8 m) and A-type USB male connector |
| N3 | Output with PVC cable (length 3 m) and A-type USB male connector |
| N5 | Output with PVC cable (length 5 m) and A-type USB male connector (available only via USB 2.0) |

| Front connection | |
|------------------|----------------------------------|
| A | A-type USB 3.0 integrated socket |
| C | A-type USB 2.0 integrated socket |



Technical data

General data

| | |
|--------------------------------|--|
| Connections: | USB 3.0 or USB 2.0 |
| Protection degree: | IP67 acc. to EN 60529 (with closed cap) |
| Ambient temperature: | -25°C ... +70°C |
| Tightening torque of the ring: | 2 ... 2.5 Nm |
| Utilization requirements: | see page 169 |

In compliance with standards:

IEC 60947-1, IEC 60947-5-1, IEC 60204-1, EN 60947-1, EN 60947-5-1, EN 60204-1, EN IEC 63000, UL 508, CSA C22.2 No. 14.

Compliance with the requirements of:

Low Voltage Directive 2014/35/EU, EMC Directive 2014/30/EU, RoHS Directive 2011/65/EU.

Main features

- Two data transfer speeds
- Protection degree IP67
- Version with socket/socket
- Version with socket / cable with male connector

Features approved by UL

Ratings: 1.8 A (Supplied by class 2 or limited energy external power supply source)
 With port cover in open position "For Use on a Flat Surface of a Type 1"
 With port cover in close position "For Use on a Flat Surface of a Type 1, 4X, 12 and 13"
 Tightening torque 2.0 Nm.

Please contact our technical department for the list of approved products.

Quality marks:



UL approval: E131787
 EAC approval: RU C-IT.YT03.B.00035/19

General data

USB 3.0 High Speed



The USB socket for Ø 22 mm buttons uses latest-generation USB 3.0 connectors, in order to offer maximum data transfer speed. Moreover, the socket is also backward compatible with previous USB connectors.

The data transfer speed depends on the chain of devices connected to the USB port, and the operating system used.

USB 2.0



The USB socket for Ø 22 mm buttons is available with USB 2.0 connectors and standard data transfer speed. This option offers the best value for money.

Shaped ring

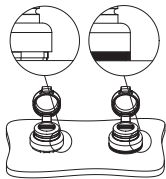

The shaped ring can be used when no label holder or other devices are applied; it prevents dirt and other residues from settling between the socket and the panel or housing.

This turns out to be particularly useful in the sectors where high standards of cleanness and hygiene are required.

Integrated protection cap

The protection cap integrated in the device ensures maximum resistance, preventing any water or dirt to get inside. The cap remains attached to the device even when it is not fastened, avoiding it to get lost; besides, its design allows the mounting of label holders.

Versions with socket and with cable

For making device installation flexible and suitable for any situation there are two versions available:

- with socket-to-socket connection

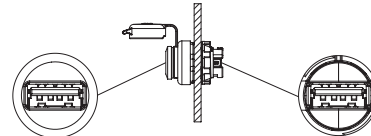

- with female connector / cable with male connector (available in different lengths)

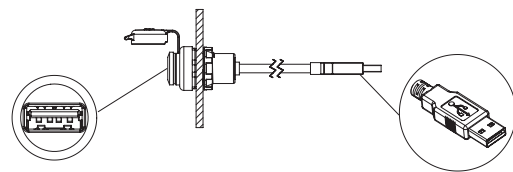

Dimensional drawings

All values in the drawings are in mm

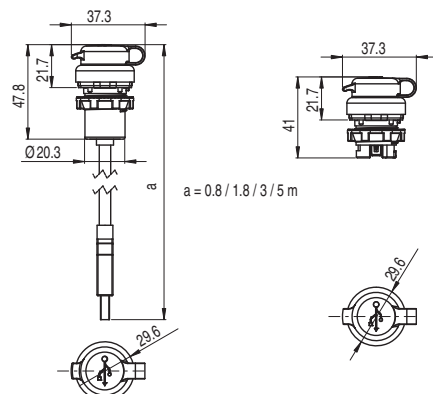

Selection diagram

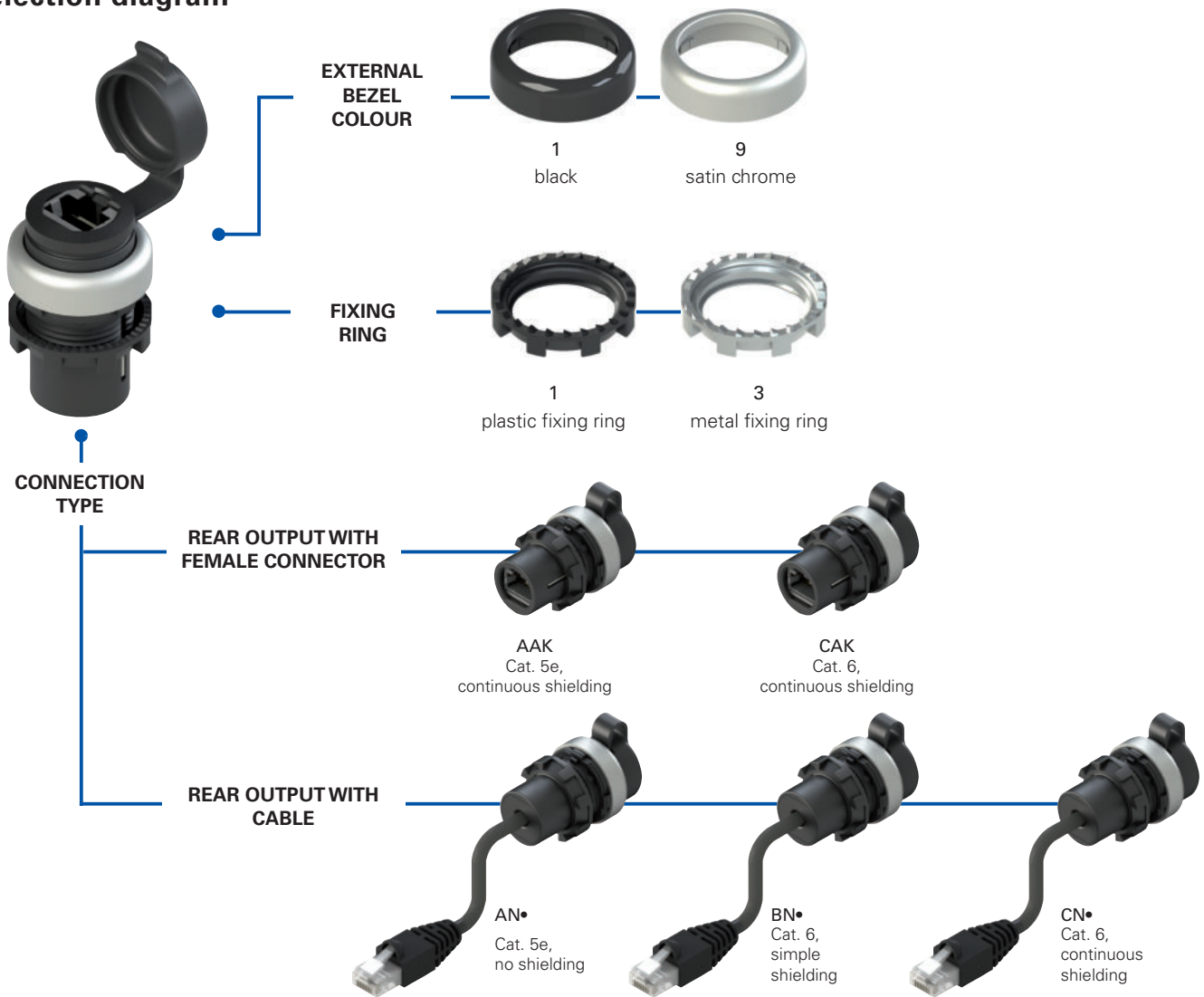

Code structure

Attention! The feasibility of a code number does not mean the effective availability of a product. Please contact our sales office.

E2 1RJ459AAK

| Fixing ring and shaped ring | |
|-----------------------------|-------------------------------------|
| 1 | plastic fixing ring (standard) |
| 2 | plastic fixing ring and shaped ring |
| 3 | metal fixing ring |
| 4 | metal fixing ring and shaped ring |

| External bezel colour | |
|-----------------------|-------------------------|
| 1 | black (standard) |
| 9 | satin chrome (standard) |

| Connection type | |
|-----------------|---|
| AAK | Rear output with female connector, Cat. 5e, continuous shielding |
| CAK | Rear output with female connector, Cat. 6, continuous shielding |
| AN1 | Rear output with 1 m long PVC cable, Cat. 5e, no shielding |
| AN1.5 | Rear output with 1.5 m long PVC cable, Cat. 5e, no shielding |
| AN2.5 | Rear output with 2.5 m long PVC cable, Cat. 5e, no shielding |
| BN1 | Rear output with 1 m long PVC cable, Cat. 6, simple shielding |
| BN1.5 | Rear output with 1.5 m long PVC cable, Cat. 6, simple shielding |
| BN2.5 | Rear output with 2.5 m long PVC cable, Cat. 6, simple shielding |
| CN1 | Rear output with 1 m long PVC cable, Cat. 6, continuous shielding |
| CN1.5 | Rear output with 1.5 m long PVC cable, Cat. 6, continuous shielding |
| CN2.5 | Rear output with 2.5 m long PVC cable, Cat. 6, continuous shielding |



Main features

- RJ45 connectors available for speeds of up to 10 Gb/s
- Protection degree IP67
- Version with socket/socket
- Version with socket / cable with male connector
- Available as shielded version

Quality marks:



UL approval: E131787
 EAC approval: RU C-IT.YT03.B.00035/19

Technical data

General data

| | |
|--------------------------------|--|
| Connections: | RJ45 connectors |
| Data transmission speed: | Up to 1 Gb/s for Cat. 5e Up to 10 Gb/s for Cat. 6 |
| Protection degree: | IP67 acc. to EN 60529 (with closed cap) |
| Ambient temperature: | -25°C ... +70°C |
| Tightening torque of the ring: | 2 ... 2.5 Nm |
| Utilization requirements: | see page 169 |

In compliance with standards:

IEC 60947-1, IEC 60947-5-1, IEC 60204-1, EN 60947-1, EN 60947-5-1, EN 60204-1, EN IEC 63000, UL 508, CSA C22.2 No. 14.

Compliance with the requirements of:

Low Voltage Directive 2014/35/EU, EMC Directive 2014/30/EU, RoHS Directive 2011/65/EU.

Features approved by UL

Ratings: 30 Vac, 1.5 A (Supplied by class 2 or limited energy external power supply source)
 With port cover in open position "For Use on a Flat Surface of a Type 1"
 With port cover in close position "For Use on a Flat Surface of a Type 1, 4X, 12 and 13"
 Tightening torque 2.0 Nm.

Please contact our technical department for the list of approved products.

General data

RJ45

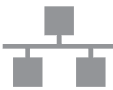

The network socket uses RJ45 connectors, for Ethernet networks. Its particular structure makes it possible to bring the Ethernet connection outside the electrical panel, without necessarily needing it to be opened.

Metal fixing ring



The fixing ring in metal is particularly suitable for those applications which require tighter fitting of the panel-mounted device, such as for example in metal panels having holes without reference notches.

Protection degree IP67

IP67 These devices are designed to be used under the toughest environmental conditions, and they pass the IP67 immersion test acc. to EN 60529. They can therefore be used in all environments where the maximum degree of protection is required for the housing.

Shaped ring

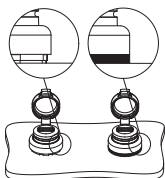

The shaped ring can be used when no label holder or other devices are applied; it prevents dirt and other residues from settling between the socket and the panel or housing. This turns out to be particularly useful in the sectors where high standards of cleanness and hygiene are required.

Integrated protection cap

The protection cap integrated in the device ensures maximum resistance, preventing any water or dirt to get inside. The cap remains attached to the device even when it is not fastened, avoiding it to get lost; besides, its design allows the mounting of label holders.

Transmission speed (Cat. 6) and shielding

The RJ45 network sockets comply with the latest data transmission standards and are suitable for transmission speeds of up to 10 Gb/s, which is ideal for modern high-tech applications, where machinery must be connected to corporate networks and be able to process large files. The RJ45 sockets are also available with a full shielding option for front and rear connection or with simple shielding on the output cable (the latter only for versions with rear cable connection). Effective internal shielding is useful in the event of any electromagnetic interference, which can disturb or compromise the quality of data transmission.

Dimensional drawings

All values in the drawings are in mm

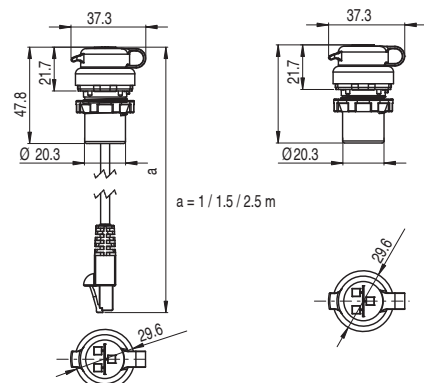

Selection diagram

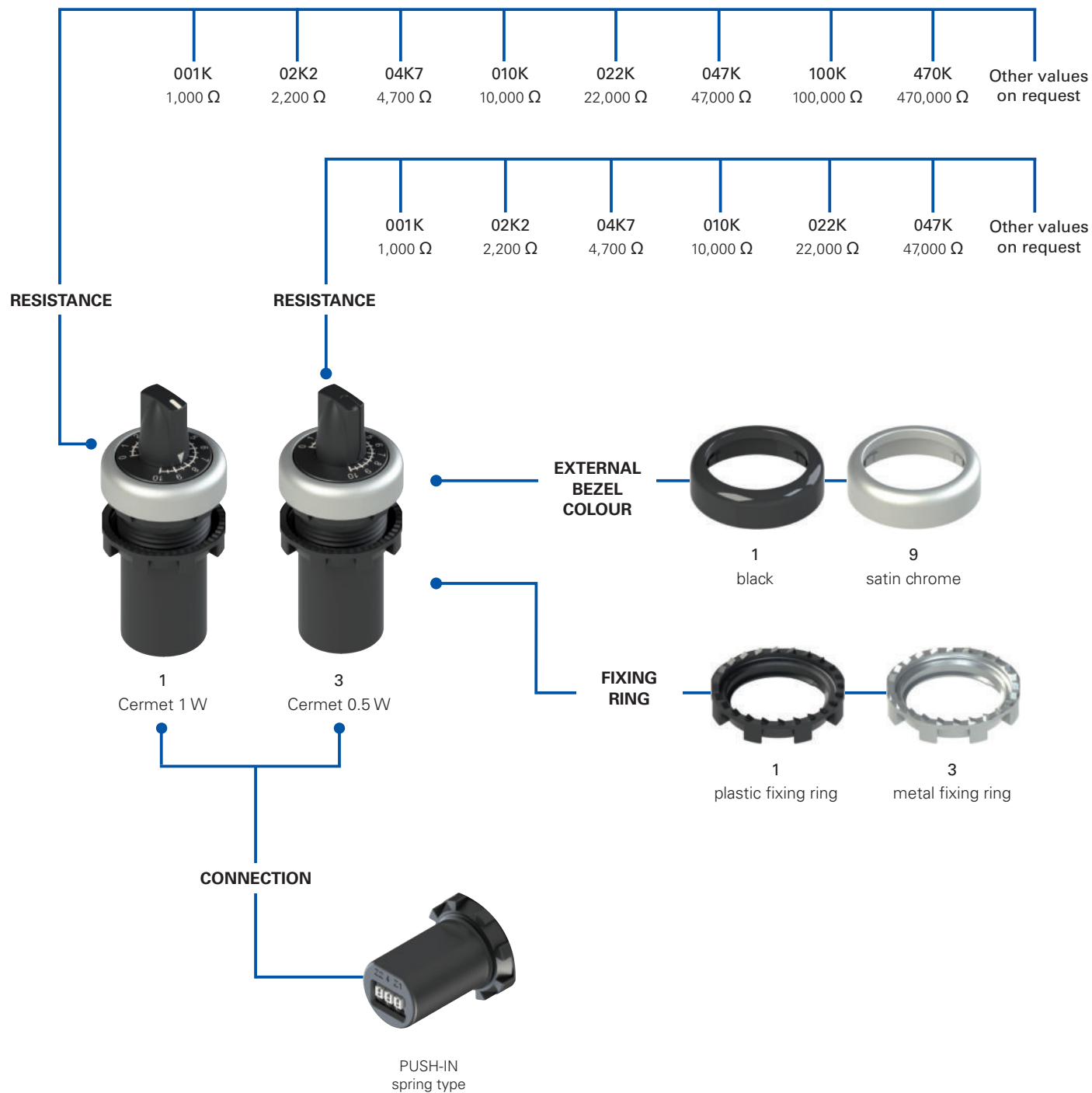

Code structure **Attention!** The feasibility of a code number does not mean the effective availability of a product. Please contact our sales office.

E6 1DM02K2-D111

| Fixing ring and shaped ring | |
|-----------------------------|-------------------------------------|
| 1 | plastic fixing ring (standard) |
| 2 | plastic fixing ring and shaped ring |
| 3 | metal fixing ring |
| 4 | metal fixing ring and shaped ring |

| External bezel colour | |
|-----------------------|-------------------------|
| 1 | black (standard) |
| 9 | satin chrome (standard) |

| Resistance | |
|-------------|--------------------------------|
| 001K | 1 kΩ |
| 02K2 | 2.2 kΩ |
| 04K7 | 4.7 kΩ |
| 010K | 10 kΩ |
| 022K | 22 kΩ |
| 047K | 47 kΩ |
| 100K | 100 kΩ (for 1 W versions only) |
| 470K | 470 kΩ (for 1 W versions only) |

| Potentiometer type | |
|--------------------|--------------|
| 1 | Cermet 1 W |
| 3 | Cermet 0.5 W |

Potentiometer version 0.5 W
Package with **50 pc.**

Other values on request.



Main features

- Fully integrated potentiometer in monolithic body
- Protection degrees IP67 and IP69K
- Rotary potentiometer with Cermet technology
- 3-pole PUSH-IN type spring-operated connection system
- Various resistance values

Quality marks:



UL approval: E131787
EAC approval: RU C-IT.YT03.B.00035/19

Features approved by UL

Ratings: 30 Vac, 31 mA (Supplied by class 2 or limited energy external power supply source).
For Use on a Flat Surface of a Type 1, 4X, 12 and 13.
Tightening torque 2.0 Nm.

Please contact our technical department for the list of approved products.

Technical data

General data

| | |
|---------------------------------------|--|
| Protection degree: | IP67 acc. to EN 60529 IP69K acc. to ISO 20653 |
| Ambient temperature: | -40°C ... +80°C |
| Mechanical endurance: | |
| 1 W version | 50,000 operating cycles |
| 0.5 W version | 10,000 operating cycles |
| Tightening torque of the fixing ring: | 2 ... 2.5 Nm |
| Utilization requirements: | see page 169 |

Electrical data

| | |
|---|--|
| Rated insulation voltage (Ui): | |
| 1 W version | 300 Vac/dc |
| 0.5 W version | 200 Vac |
| Resistive material: | Cermet |
| Operation: | linear |
| Resistance tolerance: | ±10% |
| Cross-section of rigid/flexible wires w. wire-end sleeve: | min. 1 x 0.34 mm ² (1 x AWG 24) max 1 x 1.5 mm ² (1 x AWG 16) |
| Wire cross-section with pre-insulated wire-end sleeve: | min. 1 x 0.34 mm ² (1 x AWG 24) max. 1 x 0.75 mm ² (1 x AWG 18) |
| Connection system: | PUSH-IN spring type |
| Cable stripping length (x): | min. 8 mm, max. 12 mm |



Pin assignment:

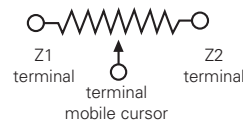

Application features, 1 W version:

| Resistance | Rated operating voltage U _e max | Rated operating current I _e max | Max power (70 °C) |
|------------|---|--|----------------------|
| 1 kΩ | 31 V | 31 mA | 1 W |
| 2.2 kΩ | 46 V | 21 mA | 1 W |
| 4.7 kΩ | 63 V | 14 mA | 1 W |
| 10 kΩ | 100 V | 10 mA | 1 W |
| 22 kΩ | 148 V | 6.7 mA | 1 W |
| 47 kΩ | 217 V | 4.6 mA | 1 W |
| 100 kΩ | 300 V | 3 mA | 0.9 W |
| 470 kΩ | 300 V | 0.75 mA | 0.23 W |

Other resistance values are available. Please contact our sales office.

Application features, 0.5 W version:

| Resistance | Rated operating voltage U _e max | Rated operating current I _e max | Max power (70 °C) |
|------------|---|--|----------------------|
| 1 kΩ | 21 V | 23.8 mA | 0.5 W |
| 2.2 kΩ | 31 V | 16.1 mA | 0.5 W |
| 4.7 kΩ | 46 V | 10.8 mA | 0.5 W |
| 10 kΩ | 67 V | 7.4 mA | 0.5 W |
| 22 kΩ | 99 V | 5.0 mA | 0.5 W |
| 47 kΩ | 145 V | 3.4 mA | 0.5 W |

Other resistance values are available. Please contact our sales office.

In compliance with standards:

IEC 60947-1, IEC 60947-5-1, IEC 60204-1, EN 60947-1, EN 60947-5-1, EN 60204-1, EN IEC 63000, UL 508, CSA C22.2 No. 14.

Compliance with the requirements of:

Low Voltage Directive 2014/35/EU, EMC Directive 2014/30/EU, RoHS Directive 2011/65/EU.

General data

Integrated potentiometer



Thanks to its monolithic shape, it has been possible to integrate all the mechanical and electrical components needed for its end use inside the E6 series potentiometer body; it is therefore not necessary to assemble any other parts, such as knobs or trimmers, all that is required is to insert the circuit wires into the incorporated terminal board.

Moreover, the resistive element used is made of a composite ceramic and metal material, produced with the Cermet technology, which ensures remarkable stability and constancy in the set resistance value.

PUSH-IN spring-operated connection

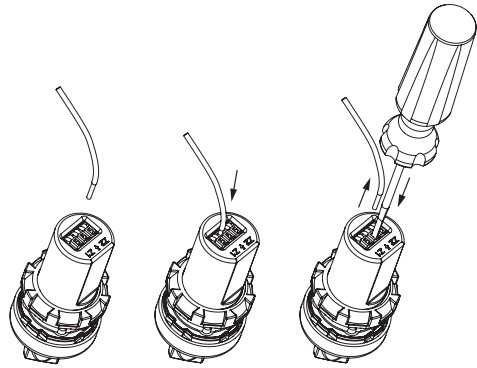

The potentiometer is provided with a three-pole terminal board with PUSH-IN type spring-operated connection. This technology allows a very handy quick wiring procedure. The wire is simply inserted into the appropriate hole, without the need for any auxiliary tooling, through the use of rigid or flexible wires with crimped wire-end sleeve. Release is obtained by pressing the appropriate wire-releasing button.

Protection degrees IP67 and IP69K

IP69K
IP67

These devices are designed to be used under the toughest environmental conditions, and they pass the IP67 immersion test acc. to EN 60529. They can therefore be used in all environments where the maximum degree of protection is required for the housing. Due to their special design, these devices are suitable for use in equipment subjected to cleaning with high pressure hot water jets. These devices meet the IP69K test requirements according to ISO 20653 (water jets with 100 bar and 80°C).

Shaped ring

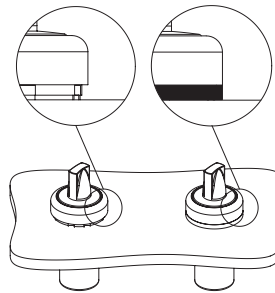

The shaped ring can be used when no label holder or other devices are applied; it prevents dirt and other residues from settling between the potentiometer and the panel or housing.

This turns out to be particularly useful in the sectors where high standards of cleanliness and hygiene are required.

Metal fixing ring



The fixing ring in metal is particularly suitable for those applications which require tighter fitting of the panel-mounted device, such as for example in metal panels having holes without reference notches.

Dimensional drawings All values in the drawings are in mm

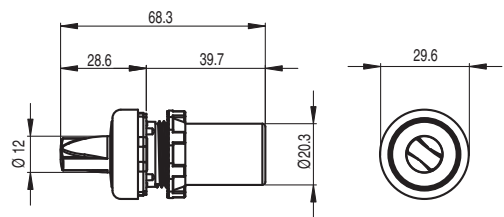

Selection diagram

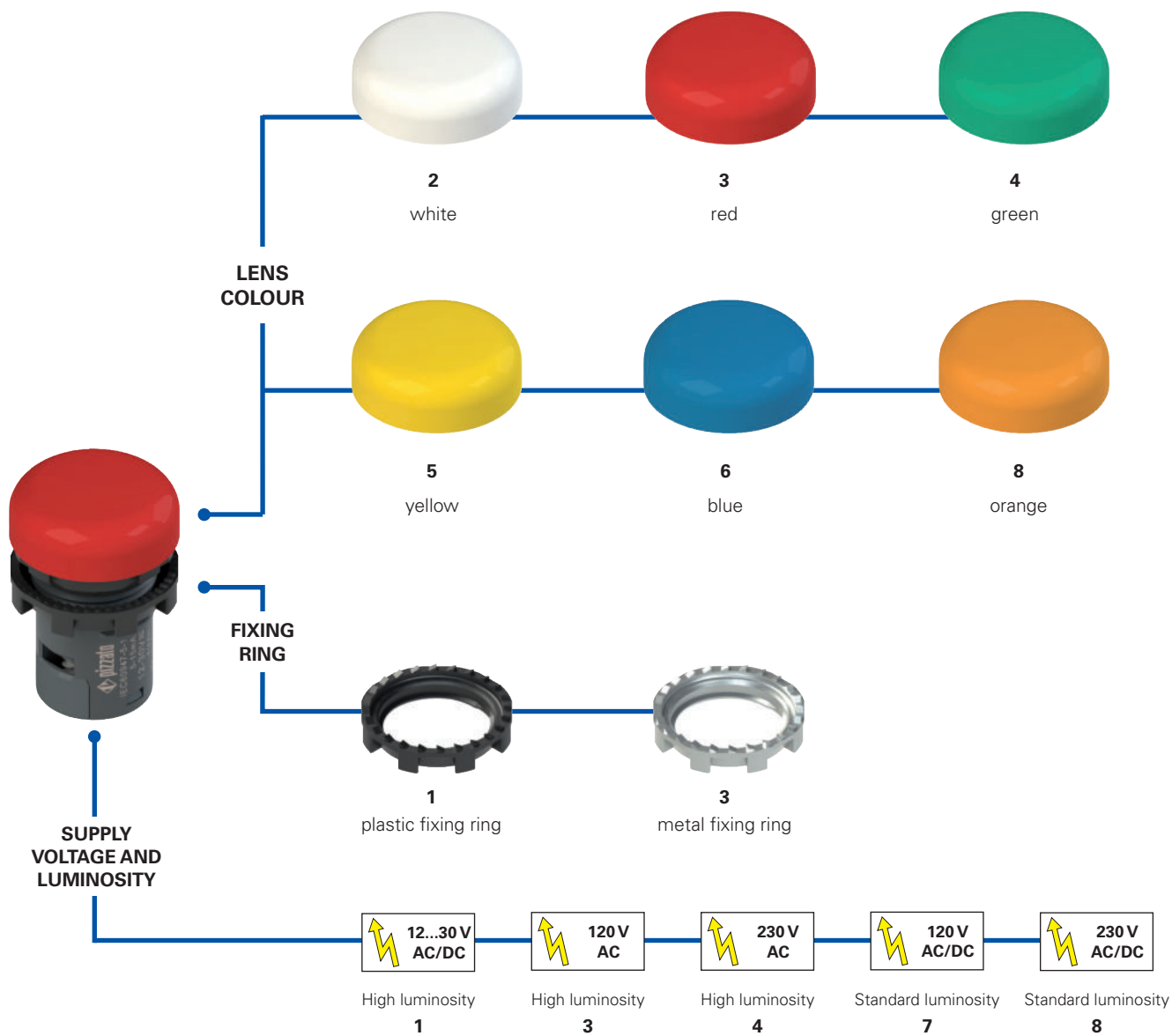

Code structure **Attention!** The feasibility of a code number does not mean the effective availability of a product. Please contact our sales office.

E6 1IL1A2110

| Fixing ring and shaped ring | |
|-----------------------------|-------------------------------------|
| 1 | plastic fixing ring (standard) |
| 2 | plastic fixing ring and shaped ring |
| 3 | metal fixing ring |
| 4 | metal fixing ring and shaped ring |

| Engraving | |
|------------|--|
| 0 | no engraving (standard) |
| IT7 | IN SERVIZIO |
| L54 |  |
| ... | ... |

Other engravings on request. See page 165.

| Supply voltage | |
|----------------|----------------------------------|
| 1 | 12 ... 30 Vac/dc high luminosity |
| 3 | 120 Vac high luminosity |
| 4 | 230 Vac high luminosity |
| 7 | 120 Vac/dc standard luminosity |
| 8 | 230 Vac/dc standard luminosity |

| Lens colour | |
|-------------|--------|
| 2 | white |
| 3 | red |
| 4 | green |
| 5 | yellow |
| 6 | blue |
| 8 | orange |



Main features

- Fully integrated indicator light in monolithic body
- Protection degrees IP67 and IP69K
- Three supply voltages:
12 ... 30 Vac/dc, 120 Vac/dc, 230 Vac/dc
- Customisation with symbols available

Quality marks:



UL approval: E131787
EAC approval: RU C-IT.YT03.B.00035/19

Technical data

General data

| | |
|---|--|
| Protection degree: | IP67 acc. to EN 60529 IP69K acc. to ISO 20653 (with shaped ring VE GP12H1A or label holder VE PT32A00A0) |
| Ambient temperature: | -40°C ... +70°C |
| Endurance: | Min. 50,000 hours (at rated voltage and +25 °C ambient temperature) |
| Tightening torque of the terminal screws: | 0.8 ... 1 Nm |
| Tightening torque of the fixing ring: | 2 ... 2.5 Nm |
| Utilization requirements: | see page 169 |

LED unit

Operating voltages and currents (high luminosity versions):

12 ... 30 Vac/dc; 5 ... 15 mA
102 ... 138 Vac; 20 mA max.
195 ... 264 Vac; 20 mA max.

Operating voltages and currents (standard luminosity versions):

102 ... 138 Vac/dc; 2.5 mA
195 ... 264 Vac/dc; 2.5 mA

Cable cross section:

min 1 x 0.34 mm² (1 x AWG 22)
max. 2 x 1.5 mm² (2 x AWG 16)

Cable stripping length (x):

6 mm



In compliance with standards:

IEC 60947-1, IEC 60947-5-1, IEC 60204-1, EN 60947-1, EN 60947-5-1, EN 60204-1, EN IEC 63000, UL 508, CSA C22.2 No. 14.

Compliance with the requirements of:

Low Voltage Directive 2014/35/EU,
EMC Directive 2014/30/EU,
RoHS Directive 2011/65/EU.

Features approved by UL

For Use on a Flat Surface of a Type 1, 4X, 12 and 13
Pollution degree 2
Overvoltage category 3
Wire range 16-22 AWG
The tightening torque of the Terminals Block is 0.8-1.0 Nm

General data

Protection degrees IP67 and IP69K

IP69K
IP67

These devices are designed to be used under the toughest environmental conditions, and they pass the IP67 immersion test acc. to EN 60529. They can therefore be used in all environments where the maximum degree of protection is required for the housing. Due to their special design, these devices are suitable for use in equipment subjected to cleaning with high pressure hot water jets. These devices meet the IP69K test requirements according to ISO 20653 (water jets with 100 bar and 80°C).

Integrated screw connection

The shape of the type E6 indicator light, though very compact, allows the integration on the device of all components for proper installation and functioning. All that is required is to wire the device by means of its screw terminals in a quick and intuitive way. There is no need to install further components.

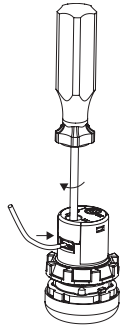

Metal fixing ring



The fixing ring in metal is particularly suitable for those applications which require tighter fitting of the panel-mounted device, such as for example in metal panels having holes without reference notches.

Shaped ring

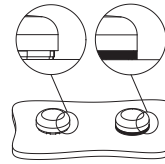







The shaped ring can be used when no label holder or other devices are applied; it prevents dirt and other residues from settling between the indicator and the panel or housing.

This turns out to be particularly useful in the sectors where high standards of cleanness and hygiene are required.

Selection table

Packs of **10 pcs.**

| Colour | Operating voltage | | | | |
|--|-----------------------------------|----------------------------|----------------------------|-----------------------------------|-----------------------------------|
| | 12 - 30 Vac/dc High luminosity | 120 Vac High luminosity | 230 Vac High luminosity | 120 Vac/dc Standard luminosity | 230 Vac/dc Standard luminosity |
|  white | E6 1IL1A2110 | E6 1IL3A2110 | E6 1IL4A2110 | E6 1IL7A2110 | E6 1IL8A2110 |
|  red | E6 1IL1A3110 | E6 1IL3A3110 | E6 1IL4A3110 | E6 1IL7A3110 | E6 1IL8A3110 |
|  green | E6 1IL1A4110 | E6 1IL3A4110 | E6 1IL4A4110 | E6 1IL7A4110 | E6 1IL8A4110 |
|  yellow | E6 1IL1A5110 | E6 1IL3A5110 | E6 1IL4A5110 | E6 1IL7A5110 | E6 1IL8A5110 |
|  blue | E6 1IL1A6110 | E6 1IL3A6110 | E6 1IL4A6110 | E6 1IL7A6110 | E6 1IL8A6110 |
|  orange | E6 1IL1A8110 | E6 1IL3A8110 | E6 1IL4A8110 | E6 1IL7A8110 | E6 1IL8A8110 |

Dimensional drawings

All values in the drawings are in mm

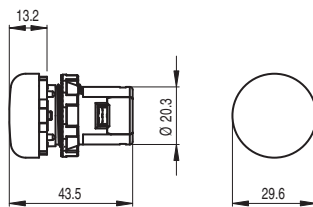

Minimum distances for installation

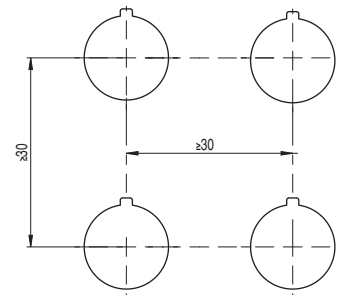

→ The 2D and 3D files are available at www.pizzato.com

Selection diagram

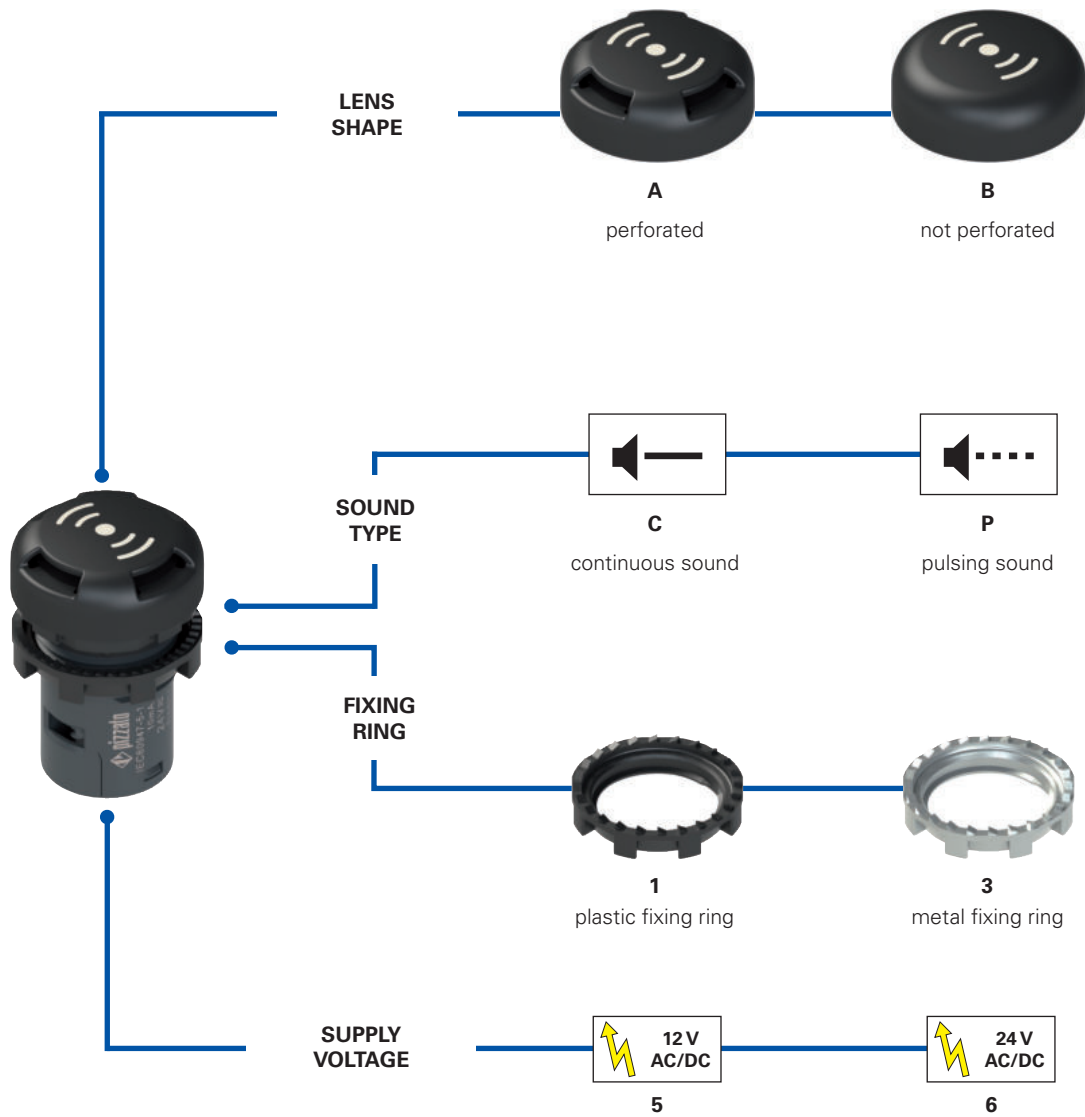

Code structure**Attention!** The feasibility of a code number does not mean the effective availability of a product. Please contact our sales office.**E6 1IS6A1CV1B**

| Fixing ring and shaped ring | | Sound type | |
|-----------------------------|-------------------------------------|------------|------------------|
| 1 | plastic fixing ring | C | continuous sound |
| 2 | plastic fixing ring and shaped ring | P | pulsing sound |
| 3 | metal fixing ring | | |
| 4 | metal fixing ring and shaped ring | | |

| Supply voltage | | Lens shape | |
|----------------|-----------|------------|----------------|
| 5 | 12 Vac/dc | A | perforated |
| 6 | 24 Vac/dc | B | not perforated |



Main features

- Buzzer fully integrated in a reduced-size monolithic body
- Protection degree up to IP67 and IP69K
- Continuous sound and pulsed sound versions
- High sound intensity
- 12 Vac/dc or 24 Vac/dc versions

Quality marks:



UL approval: E131787
EAC approval: RU C-IT.YT03.B.00035/19

Technical data

General data

| | |
|---|--|
| Protection degree: | IP40 acc. to EN 60529 |
| Version with perforated lens: | IP67 acc. to EN 60529 |
| Version with perforation-free lens: | IP69K acc. to ISO 20653 (with shaped ring VE GP12H1A or label holder VE PT32A00A0) |
| Ambient temperature: | -20°C ... +70°C |
| Tightening torque of the terminal screws: | 0.8 ... 1 Nm |
| Tightening torque of the fixing ring: | 2 ... 2.5 Nm |
| Utilization requirements: | see page 169 |

Electrical data

| | |
|--|--|
| Operating voltage U_n : | 12 Vac/dc or 24 Vac/dc |
| Supply voltage tolerance: | $\pm 15\%$ of U_n |
| Operating current: | 10 mA |
| Minimum level of sound intensity: | |
| 24 Vac/dc versions: | 95 dB at 10cm (perforated lens) 80 dB at 10cm (perforation-free lens) |
| 12 Vac/dc versions: | 90 dB at 10cm (perforated lens) 75 dB at 10cm (perforation-free lens) |
| Frequency of intermittence (pulsed version): | 0.6 Hz (0.8 s ON, 0.8 s OFF) |
| Cable cross section: | min 1 x 0.34 mm ² (1 x AWG 22) max. 2 x 1.5 mm ² (2 x AWG 16) |
| Cable stripping length (x): | 6 mm |



In compliance with standards:

IEC 60947-1, IEC 60947-5-1, IEC 60204-1, EN 60947-1, EN 60947-5-1, EN 60204-1, EN IEC 63000, UL 508, CSA C22.2 No. 14.

Compliance with the requirements of:

Low Voltage Directive 2014/35/EU, EMC Directive 2014/30/EU, RoHS Directive 2011/65/EU.

Features approved by UL

Ratings: 12 Vac/dc or 24 V ac/dc (Supplied by class 2 or limited energy external power supply source)

- E6 xISxAxxxx "For Use on a Flat Surface of a Type 1"
- E6 xISxBxxxx "For Use on a Flat Surface of a Type 1, 4X, 12 and 13"

Wire range 16-22 AWG

The tightening torque of the Terminals Block is 0.8 - 1.0 Nm

General data

Protection degrees IP67 and IP69K

IP69K
IP67

These devices are designed to be used under the toughest environmental conditions, and they pass the IP67 immersion test acc. to EN 60529. They can therefore be used in all environments where the maximum degree

of protection is required for the housing. Due to their special design, these devices are suitable for use in equipment subjected to cleaning with high pressure hot water jets. These devices meet the IP69K test requirements according to ISO 20653 (water jets with 100 bar and 80°C).

Two sound types

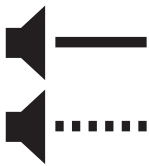

The E6 buzzer combines compact external dimensions with a high sound intensity, in particular in the versions with perforated lens. This characteristic makes the signalling clearly noticeable, even at a distance and in noisy environments.



To diversify the type of indication provided, there are two different types of acoustic warning available: continuous sound or pulsing sound.

Integrated screw connection

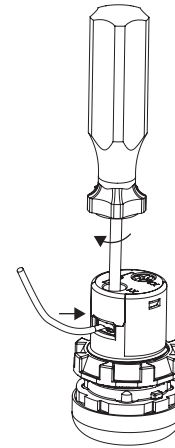
The shape of the type E6 sound indicator, though very compact, allows the integration on the device of all components for proper installation and functioning. All that is required is to wire the device by means of its screw terminals in a quick and intuitive way. There is no need to install further components.



Selection table

| Lens shape | Sound type and supply voltage | | | |
|---|-------------------------------|---------------|----------------------|---------------|
| | Continuous sound ◀— | | Pulsing sound ◀-- | |
| | 12 Vac/dc | 24 Vac/dc | 12 Vac/dc | 24 Vac/dc |
|  perforated | E6 1IS5A1CV1B | E6 1IS6A1CV1B | E6 1IS5A1PV1B | E6 1IS6A1PV1B |
|  not perforated | E6 1IS5B1CV1B | E6 1IS6B1CV1B | E6 1IS5B1PV1B | E6 1IS6B1PV1B |

Dimensional drawings

All values in the drawings are in mm

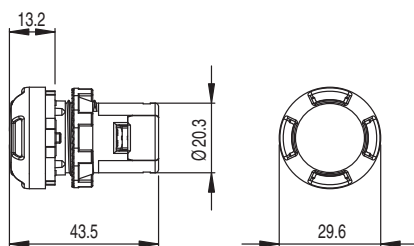

Minimum distances for installation

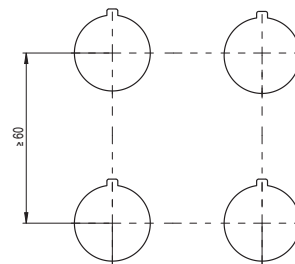

→ The 2D and 3D files are available at www.pizzato.com

Selection diagram

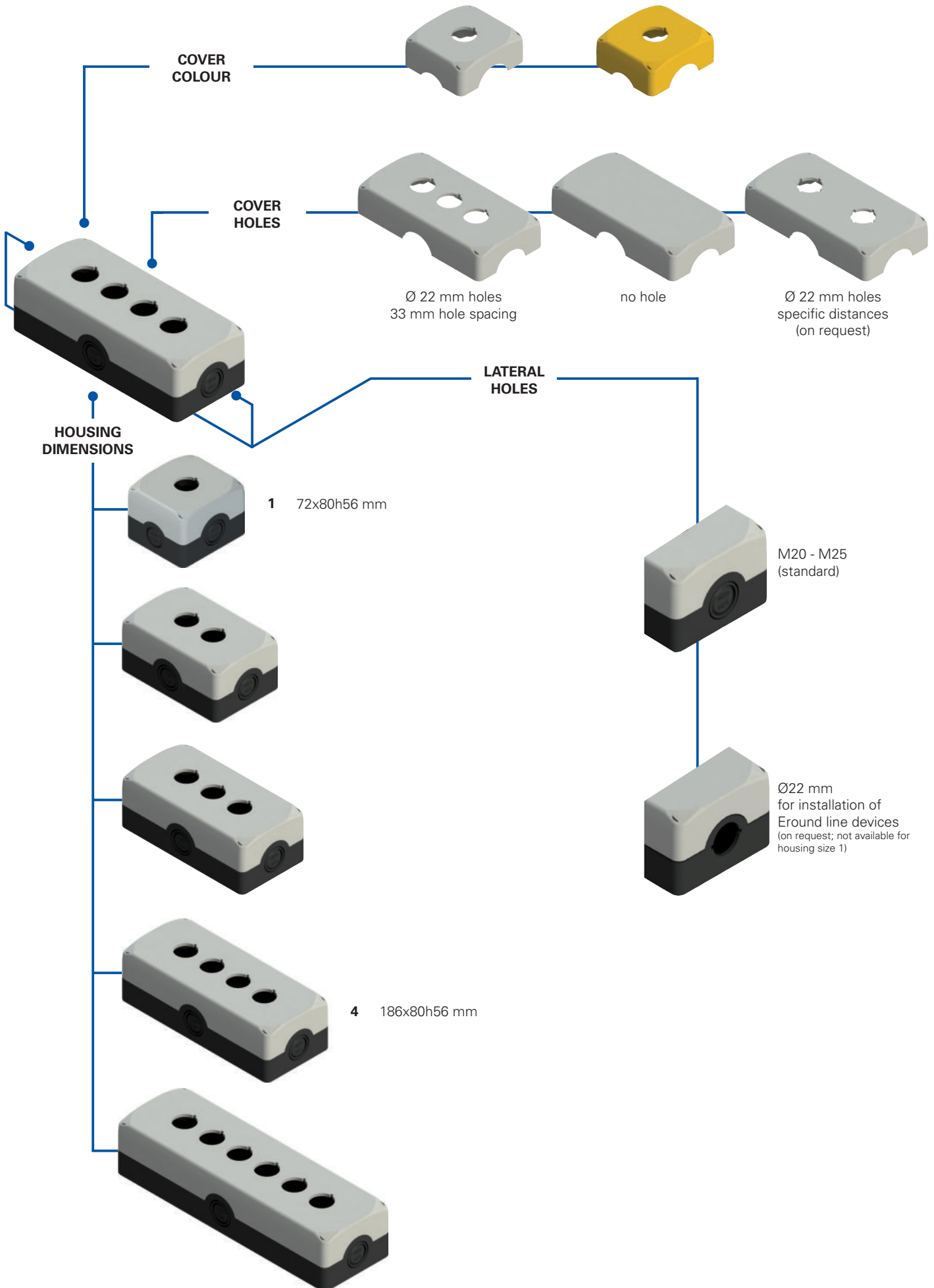

Code structure**Attention!** The feasibility of a code number does not mean the effective availability of a product. Please contact our sales office.

ES 31000

| Body material | |
|---------------|-----------------------------|
| 3 | polycarbonate PC (standard) |

| Housing dimensions | |
|--------------------|--------------|
| 1 | 72x80h56 mm |
| 2 | 120x80h56 mm |
| 3 | 153x80h56 mm |
| 4 | 186x80h56 mm |
| 6 | 252x80h56 mm |

| Configuration | |
|---------------|--------------------------|
| 000 | black base, grey cover |
| 001 | black base, yellow cover |
| ... | ... |

Other combinations on request.

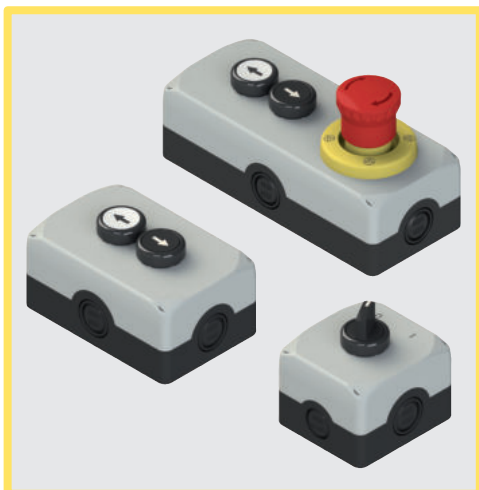

Main features

- Protection degrees IP67 and IP69K
- Stainless steel captive screws
- 4 side cable entries
- Screw caps included in the scope of supply

Quality marks:



EAC approval: RU C-IT.YT03.B.00035/19
UL approval: E131787

Technical data

Housing

Material: Self-extinguishing shock-proof polycarbonate with double insulation, UV-resistant and glass fibre reinforced, high shock resistance.

Material of the screws: Stainless steel

Protection degree: IP67 acc. to EN 60529

IP69K acc. to ISO 20653 (cable gland of equal or higher protection degree)

Conduit entries:

Housing (1 hole): 4x knock-out side entries:
2x M20 - 1/2 NPT, 2x M20 - 1/2 NPT - M25
2x M16 knock-out base entries

Housings with 2-3-4-6 holes:

4x knock-out side entries:
4x M20 - 1/2 NPT - M25
2x M20 knock-out base entries

Device installation:

Suitable for the installation of Ø 22 mm control and signalling devices.

Ø 22 mm hole acc. to EN 60947-5-1

Utilization requirements:

see page 169

General data

Ambient temperature: -40°C ... +80°C

Tightening torque of the cover screws: 1 ... 1.4 Nm

In compliance with standards:

IEC 60947-1, IEC 60947-5-1, IEC 60204-1, EN 60947-1, EN 60947-5-1, EN 60204-1, EN IEC 63000, UL 508, CSA C22.2 No. 14.

Compliance with the requirements of:

Low Voltage Directive 2014/35/EU, EMC Directive 2014/30/EU, RoHS Directive 2011/65/EU.

Features approved by UL

- The Tightening Torque value of cover screws: "Torque 1-1.4 Nm"
- The enclosed control box series ES and EA can be provided empty (without actuators and contact blocks) or equipped with actuators and contact blocks
- Empty version of Enclosed Control Stations ES and EA are already provided of holes for actuators
- Enclosed Control Stations ES and EA cannot be provided of mushroom actuators equipped with red head and yellow background
- Enclosed Control Stations ES and EA provided with yellow cover are not suitable for use with mushroom actuator with red head
- The Enclosed Control Stations ES and EA are suitable for conduit connection only
- For the enclosed control box series ES, the hub is to be connected to the conduit before the hub is connected to the enclosure
- For polymeric Enclosures that are intended for field assembly of the bonding means shall be located where visible during installation, such as inside the cover, and consist of the word "CAUTION" and the following or the equivalent, "Bonding between conduit connections is not automatic and must be provided as a part of the installation"; or the word "CAUTION" and the following or equivalent, "Nonmetallic enclosure does not provide grounding between conduit connection. Use grounding bushings and jumper wires"
- The maximum number of contact block for each hole of the Enclosed Control Stations ES and EA is 4
- The illuminated disk VE DL series as polymeric component assembled to Enclosed Control Stations ES and EA covers a hole of 5,5 mm diameter

General data

Protection degrees IP67 and IP69K

IP69K
IP67

These devices are designed to be used under the toughest environmental conditions, and they pass the IP67 immersion test acc. to EN 60529. They can therefore be used in all environments where the maximum degree of

protection is required for the housing. Due to their special design, these devices are suitable for use in equipment subjected to cleaning with high pressure hot water jets. These devices meet the IP69K test requirements according to ISO 20653 (water jets with 100 bar and 80°C).

Fixing of EROUND housings

The housings of the EROUND line by Pizzato Elettrica have 4 additional holes on the cover. The holes enable wall fixing from the outside by means of insertion of the screws, without the need to open the cover to access the holes.

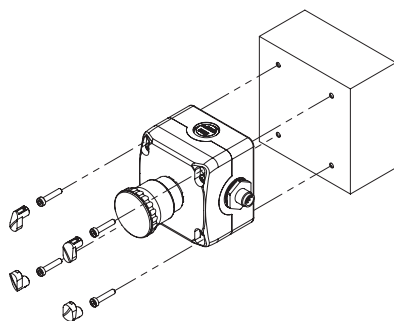

The wall fixing screws and the ones for closing the housing cover can be sealed with 4 caps (supplied with the housing). The caps not only give the housing a more pleasant look, but they also prevent the accumulation of dirt inside the recesses of the screws besides making tampering more difficult.

The external fixing of the housings is particularly valuable for already wired housings, since this simplifies the whole installation: you can simply fix the housing and connect the connector that, thanks to the presence of cable entries on the four sides of the housing, can be oriented in the preferred direction.

One housing, two solutions

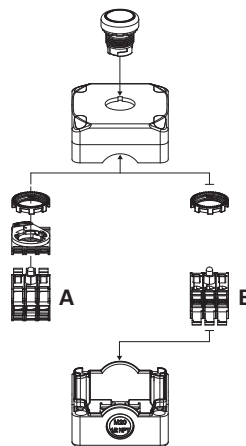

The housing can fit up to 3 contact blocks/LED units (E2 CP, E2 LP) for panel mounting by means of a mounting adapter (A) or up to 3 contact blocks/LED units (E2 CF, E2 LF) for base mounting directly on the bottom of the housing (B).



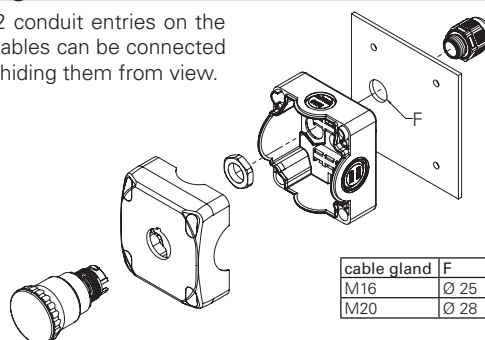

Wiring through the lower surface

Housings have 2 conduit entries on the lower surface. Cables can be connected via this surface, hiding them from view.

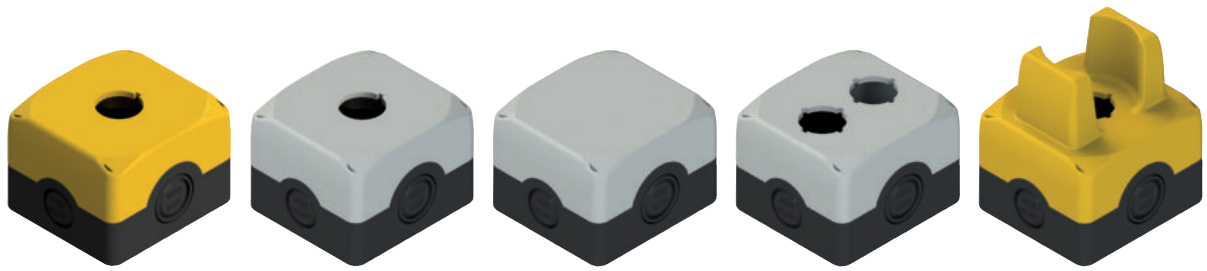



Selection table for housings



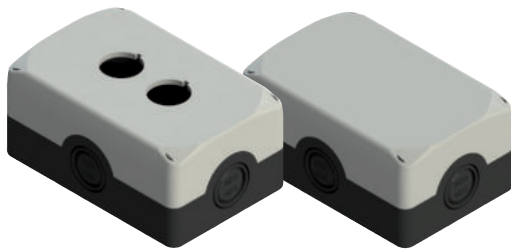

| Cover colour | Article | Ø 22 mm hole |
|---|----------|--------------|
|  yellow RAL 1003 | ES 31001 | 1 |
|  grey RAL 7035 | ES 31000 | 1 |
|  grey RAL 7035 | ES 31013 | 0 |
|  grey RAL 7035 | ES 31014 | 2 |
|  yellow RAL 1003 | ES 31015 | 1 |





| Cover colour | Article | Ø 22 mm hole |
|---|----------|--------------|
|  grey RAL 7035 | ES 32000 | 2 |
|  grey RAL 7035 | ES 32002 | 0 |







| Cover colour | Article | Ø 22 mm hole |
|---|----------|--------------|
|  grey RAL 7035 | ES 33000 | 3 |
|  grey RAL 7035 | ES 33002 | 0 |
|  grey RAL 7035 | ES 33003 | 2 |

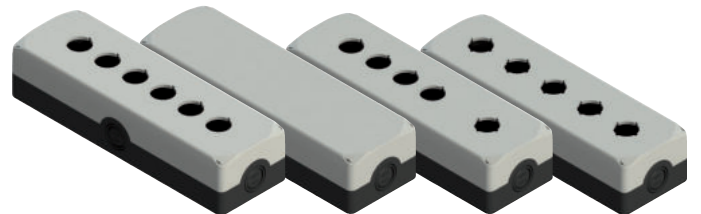

| Cover colour | Article | Ø 22 mm hole |
|---|----------|--------------|
|  grey RAL 7035 | ES 34000 | 4 |
|  grey RAL 7035 | ES 34002 | 0 |
|  grey RAL 7035 | ES 34003 | 3 |



| Cover colour | Article | Ø 22 mm hole |
|---|----------|---------------|
|  grey RAL 7035 | ES 36000 | 6 |
|  grey RAL 7035 | ES 36002 | 0 |
|  grey RAL 7035 | ES 36003 | 5 |
|  grey RAL 7035 | ES 36012 | 5 equidistant |

Note: Item ES 36012 compatible with panel-mounted contact blocks only.

Complete control device units ES AC31...



| Housing cover colour | Actuator colour and engraving | Contacts | | | Flush button black bezel | Projecting button black bezel |
|----------------------|-------------------------------|----------|--------|--------|--|--|
| | | pos. 2 | pos. 3 | pos. 1 | | |
| grey RAL 7035 | green | - | 1NO | - | ES AC31001 ES 31000 + E2 1PU2R421L2 + E2 CF10G2V1 | - |
| grey RAL 7035 | red | - | 1NC | - | ES AC31002 ES 31000 + E2 1PU2R321L1 + E2 CF01G2V1 | ES AC31017 ES 31000 + E2 1PU2S321L1 + E2 CF01G2V1 |
| grey RAL 7035 | green | - | 1NO | - | ES AC31015 ES 31000 + E2 1PU2R421GB1 + E2 CF10G2V1 | - |
| grey RAL 7035 | red | - | 1NC | - | ES AC31016 ES 31000 + E2 1PU2R321GB0 + E2 CF01G2V1 | ES AC31018 ES 31000 + E2 1PU2S321GB0 + E2 CF01G2V1 |

Other combinations on request.

→ For data regarding contact blocks, please see the respective chapters.



| Housing cover colour | Positions | Contacts | | | Black selector switch with 2 positions black bezel |
|----------------------|-----------|----------|--------|--------|---|
| | | pos. 2 | pos. 3 | pos. 1 | |
| grey RAL 7035 | ∨ | - | 1NO | - | ES AC31019 ES 31002 + E2 1SE12AVA11AB + E2 CF10G2V1 |

| Housing cover colour | Positions | Contacts | | | Black key selector switch with 2 positions black bezel |
|----------------------|-----------|----------|--------|--------|--|
| | | pos. 2 | pos. 3 | pos. 1 | |
| grey RAL 7035 | ⌘ | - | 1NO | - | ES AC31020 ES 31000 + E2 1SC2AVA11AE + E2 CF10G2V1 |

Other combinations on request.

→ For data regarding contact blocks, please see the respective chapters.

Other combinations on request.

Legend ∨ Maintained ⌘ Spring-return ⌘ Key extraction position









| Housing cover colour | Actuator design and colour | Contacts | | | Emergency stop button Push-Pull | Emergency stop button rotary release | Emergency stop button, key release |
|----------------------|----------------------------|----------|--------|--------|--|--|--|
| | | pos. 2 | pos. 3 | pos. 1 | | | |
| yellow RAL 1003 | red | - | 1NC | - | ES AC31004 ES 31001 + E2 1PEPZ4531 + E2 CF01G2V1 | ES AC31003 ES 31001 + E2 1PERZ4531 + E2 CF01G2V1 | ES AC31022 ES 31001 + E2 1PEBZ4531 + E2 CF01G2V1 |
| yellow RAL 1003 | red | - | 1NC | - | ES AC31081 ES 31001 + E2 1PEPZ4531 + E2 CF01S2V1 | ES AC31082 ES 31001 + E2 1PERZ4531 + E2 CF01S2V1 | ES AC31083 ES 31001 + E2 1PERZ4531 + E2 CF01S2V1 |
| yellow RAL 1003 | red | 1NC | - | 1NC | ES AC31009 ES 31001 + E2 1PEPZ4531 + E2 CF01G2V1 + E2 CF01G2V1 | ES AC31005 ES 31001 + E2 1PERZ4531 + E2 CF01G2V1 + E2 CF01G2V1 | ES AC31023 ES 31001 + E2 1PEBZ4531 + E2 CF01G2V1 + E2 CF01G2V1 |
| yellow RAL 1003 | red | 1NC | - | 1NO | ES AC31010 ES 31001 + E2 1PEPZ4531 + E2 CF01G2V1 + E2 CF10G2V1 | ES AC31006 ES 31001 + E2 1PERZ4531 + E2 CF01G2V1 + E2 CF10G2V1 | ES AC31011 ES 31001 + E2 1PEBZ4531 + E2 CF01G2V1 + E2 CF10G2V1 |
| yellow RAL 1003 | red | 1NC | 1NC | 1NO | ES AC31146 ES 31001 + E2 1PEPZ4531 + E2 CF01G2V1 + E2 CF01G2V1 + E2 CF10G2V1 | ES AC31021 ES 31001 + E2 1PERZ4531 + E2 CF01G2V1 + E2 CF10G2V1 | ES AC31024 ES 31001 + E2 1PEBZ4531 + E2 CF01G2V1 + E2 CF01G2V1 + E2 CF10G2V1 |

Other combinations on request.

→ For data regarding contact blocks and luminous discs, please see the respective chapters.



Complete control device units ES AC31...



| Housing cover colour | Actuator design and colour | Contacts | | | Emergency stop button Push-Pull | Emergency stop button rotary release | Emergency stop button, key release |
|----------------------|----------------------------|---|--|---|--|--|--|
| | | pos. 2 | pos. 3 | pos. 1 | | | |
| yellow RAL 1003 | red | - | 1NC  | - | ES AC31054 ES 31015 + E2 1PEPZ4531 + E2 CF01G2V1 | ES AC31238 ES 31015 + E2 1PERZ4531 + E2 CF01G2V1 | ES AC31606 ES 31015 + E2 1PEBZ4531 + E2 CF01G2V1 |
| yellow RAL 1003 | red | - | 1NC  SELF-MONITORED | - | ES AC31601 ES 31015 + E2 1PEPZ4531 + E2 CF01S2V1 | ES AC31605 ES 31015 + E2 1PERZ4531 + E2 CF01S2V1 | ES AC31607 ES 31015 + E2 1PEBZ4531 + E2 CF01S2V1 |
| yellow RAL 1003 | red | 1NC  | - | 1NC  | ES AC31602 ES 31015 + E2 1PEPZ4531 + E2 CF01G2V1 + E2 CF10G2V1 | ES AC31050 ES 31015 + E2 1PERZ4531 + E2 CF01G2V1 + E2 CF10G2V1 | ES AC31092 ES 31015 + E2 1PEBZ4531 + E2 CF01G2V1 + E2 CF10G2V1 |
| yellow RAL 1003 | red | 1NC  | - | 1NO | ES AC31603 ES 31015 + E2 1PEPZ4531 + E2 CF01G2V1 + E2 CF10G2V1 | ES AC31056 ES 31015 + E2 1PERZ4531 + E2 CF01G2V1 + E2 CF10G2V1 | ES AC31608 ES 31015 + E2 1PEBZ4531 + E2 CF01G2V1 + E2 CF10G2V1 |
| yellow RAL 1003 | red | 1NC  | 1NC  | 1NO | ES AC31604 ES 31015 + E2 1PEPZ4531 + E2 CF01G2V1 + E2 CF01G2V1 + E2 CF10G2V1 | ES AC31332 ES 31015 + E2 1PERZ4531 + E2 CF01G2V1 + E2 CF10G2V1 | ES AC31609 ES 31015 + E2 1PEBZ4531 + E2 CF01G2V1 + E2 CF10G2V1 |

Complete control device units ES AC31... with luminous disc



| Housing cover colour | Actuator design and colour | Contacts | | | Emergency stop button Push-Pull Yellow luminous disc, flashing Ø 60 mm, 24 Vac/dc | Emergency stop button rotary release Yellow luminous disc, flashing Ø 60 mm, 24 Vac/dc | Emergency stop button, key release Yellow luminous disc, flashing Ø 60 mm, 24 Vac/dc |
|----------------------|----------------------------|----------|--|--------|--|--|--|
| | | pos. 2 | pos. 3 | pos. 1 | | | |
| grey RAL 7035 | red | 1NO | 1NC  CON-NECTION BLOCK | - | ES AC31430 ES 31000 + E2 1PEPZ4531 + VE DL1A5L13 + E2 1BAC11 + E2 CP10G2V1 + E2 CP01G2V1 + VE BC2PV1 | ES AC31433 ES 31000 + E2 1PERZ4531 + VE DL1A5L13 + E2 1BAC11 + E2 CP10G2V1 + E2 CP01G2V1 + VE BC2PV1 | ES AC31436 ES 31000 + E2 1PEBZ4531 + VE DL1A5L13 + E2 1BAC11 + E2 CP10G2V1 + E2 CP01G2V1 + VE BC2PV1 |
| grey RAL 7035 | red | 1NO | 1NC  SELF-MONITORED CON-NECTION BLOCK | - | ES AC31431 ES 31000 + E2 1PEPZ4531 + VE DL1A5L13 + E2 1BAC11 + E2 CP10G2V1 + E2 CP01S2V1 + VE BC2PV1 | ES AC31434 ES 31000 + E2 1PERZ4531 + VE DL1A5L13 + E2 1BAC11 + E2 CP10G2V1 + E2 CP01S2V1 + VE BC2PV1 | ES AC31437 ES 31000 + E2 1PEBZ4531 + VE DL1A5L13 + E2 1BAC11 + E2 CP10G2V1 + E2 CP01S2V1 + VE BC2PV1 |
| grey RAL 7035 | red | 1NO | 2NC  CON-NECTION BLOCK | - | ES AC31432 ES 31000 + E2 1PEPZ4531 + VE DL1A5L13 + E2 1BAC11 + E2 CP10G2V1 + E2 CP02G2V1 + VE BC2PV1 | ES AC31435 ES 31000 + E2 1PERZ4531 + VE DL1A5L13 + E2 1BAC11 + E2 CP10G2V1 + E2 CP02G2V1 + VE BC2PV1 | ES AC31438 ES 31000 + E2 1PEBZ4531 + VE DL1A5L13 + E2 1BAC11 + E2 CP10G2V1 + E2 CP02G2V1 + VE BC2PV1 |

Other combinations on request.
 → For data regarding contact blocks, please see the respective chapters.

→ The 2D and 3D files are available at www.pizzato.com

Complete control device units ES AC31... with wired M12 connector



| Housing cover colour | Actuator design and colour | Contacts | | | Emergency stop button rotary release with plastic M12 connector |
|----------------------|----------------------------|----------|-----------------------|--------|---|
| | | pos. 2 | pos. 3 | pos. 1 | |
| yellow RAL 1003 | red | - | 1NC | - | ES AC31025 |
| yellow RAL 1003 | red | - | 1NC SELF-MONITORED | - | ES AC31084 |
| yellow RAL 1003 | red | 1NC | - | 1NC | ES AC31026 |
| yellow RAL 1003 | red | 1NC | - | 1NO | ES AC31027 |
| yellow RAL 1003 | red | 1NC | 1NC | 1NO | ES AC31028 |

Other combinations on request.

→ For data regarding contact blocks, please see the respective chapters.

Wiring diagram for assembled connectors

| ES AC31025 1NC | ES AC31084 1NC SELF-MONITORED | ES AC31026 2NC | ES AC31027 1NO+1NC | ES AC31028 1NO+2NC |
|--------------------------|----------------------------------|--------------------------|--------------------------|----------------------------|
| | | | | |
| M12 connector, 4-pole | M12 connector, 4-pole | M12 connector, 4-pole | M12 connector, 4-pole | M12 connector, 8-pole |
| Contacts Pin no. | Contacts Pin no. | Contacts Pin no. | Contacts Pin no. | Contacts Pin no. |
| NC 1-2 | NC 1-2 | NC 1-2 NC 3-4 | NC 1-2 NO 3-4 | NC 3-4 NC 5-6 NO 7-8 |

Spare caps



| Article | Description |
|-----------|--|
| VETS35RA1 | 4 spare caps for ES series housing cover. Colour: yellow |
| VETS39RA1 | 4 spare caps for ES series housing cover. Colour: grey |

Accessories

→ More ACCESSORIES on page 161





ES AC31600

| Description | Features | Diagram |
|---|---|---|
| Button - 1NO E2 1PU2R221L9 Contacts 1x E2 CP10G2V1 | flush, spring-return, white pos. 2 / pos. 3 1NO pos. 1 / |  |
| Button - 1NO E2 1PU2R121L10 Contacts 1x E2 CP10G2V1 | flush, spring-return, black pos. 2 / pos. 3 1NO pos. 1 / |  |





ES AC32010

| Description | Features | Diagram |
|---|--|---|
| Button - 1NO E2 1PU2R421L35 Contacts 1x E2 CF10G2V1 | flush, spring-return, green pos. 2 / pos. 3 1NO pos. 1 / |  |
| Button - 1NC E2 1PU2S321L1 Contacts 1x E2 CF10G2V1 | projecting, spring-return, red pos. 2 / pos. 3 1NC ⊖ pos. 1 / |  |







ES AC33017

| Description | Features | Diagram |
|---|--|---|
| Button - 1NO E2 1PU2R221L9 Contacts 1x E2 CF10G2V1 | flush, spring-return, white pos. 2 / pos. 3 1NO pos. 1 / |  |
| Button - 1NC E2 1PU2S321L1 Contacts 1x E2 CF10G2V1 | projecting, spring-return, red pos. 2 / pos. 3 1NC ⊖ pos. 1 / |  |
| Button - 1NO E2 1PU2R121L10 Contacts 1x E2 CF10G2V1 | flush, spring-return, black pos. 2 / pos. 3 1NO pos. 1 / |  |



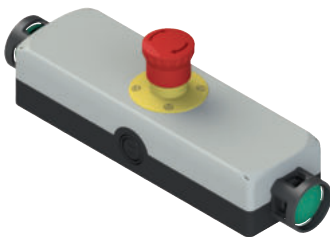

ES AC34035

| Description | Features | Diagram |
|---|---|---|
| Button - 1NO E2 1PU2R221L9 Contacts 1x E2 CP10G2V1 | flush, spring-return, white pos. 2 / pos. 3 1NO pos. 1 / |  |
| Button - 1NO E2 1PU2R121L10 Contacts 1x E2 CP10G2V1 | flush, spring-return, black pos. 2 / pos. 3 1NO pos. 1 / |  |
| Emergency stop button E2 1PERZ4531 Contacts 1x E2 CP01G2V1+1x E2 CP10G2V1 | rotary release, red pos. 2 1 NO pos. 3 / pos. 1 1NC ⊖ |  |
| Luminous disc VE DL1A5L13 | Yellow, continuous light 24 Vac/dc |  |

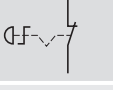

ES AC36041

| Description | Features | Diagram |
|--|--|---|
| Button - 1NO E2 1PU2F4410 Protection guard 1x VE GP32B1A Contacts 1x E2 CP10G2V1 | mushroom, spring-return, green cylindrical, black pos. 2 / pos. 3 1NO pos. 1 / |  |
| Emergency stop button - 1NC E2 1PERZ4531 Contacts 1x E2 CP10G2V1 | rotary release, red pos. 2 / pos. 3 1NC ⊖ pos. 1 / |  |
| Button - 1NO E2 1PU2F4410 Protection guard 1x VE GP32B1A Contacts 1x E2 CP10G2V1 | mushroom, spring-return, green cylindrical, black pos. 2 / pos. 3 1NO pos. 1 / |  |

Other combinations on request.

Dimensional drawings

Housings (72 x 80 h 56)

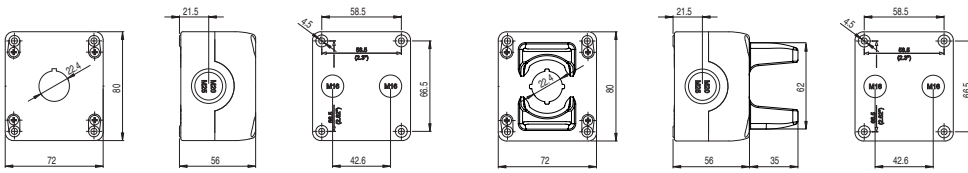

Housings (120 x 80 h 56)

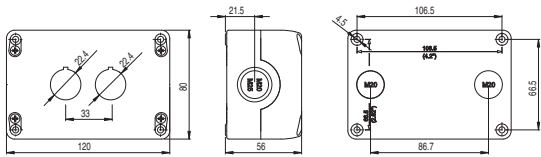

Housings (153 x 80 h 56)

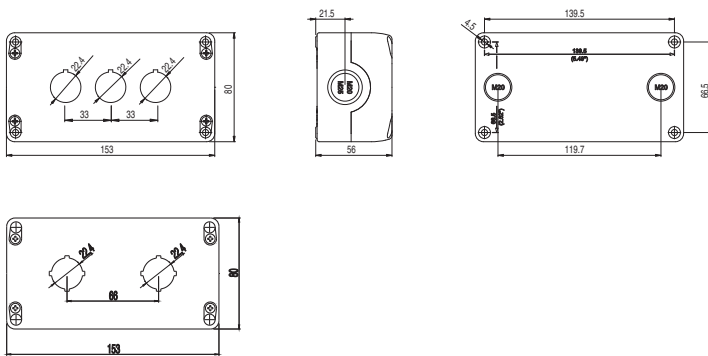

Housings (186 x 80 h 56)

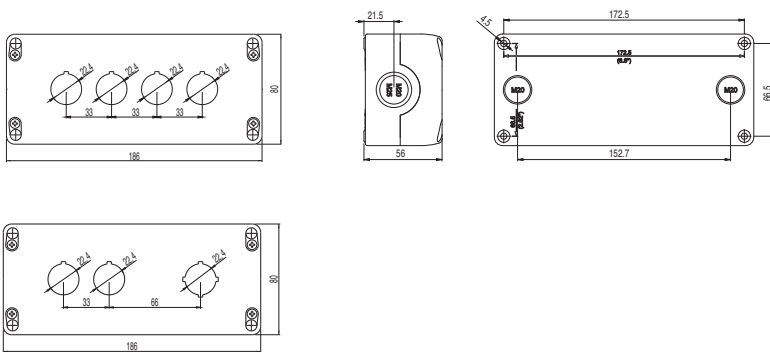

Housings (252 x 80 h 56)

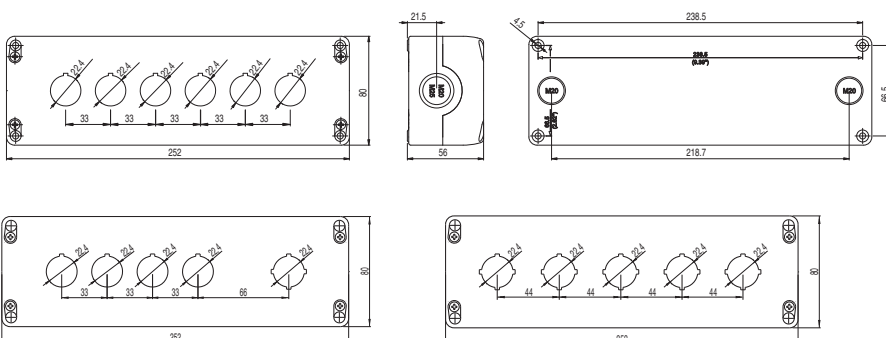

All values in the drawings are in mm

→ The 2D and 3D files are available at www.pizzato.com

Selection diagram

DEVICES

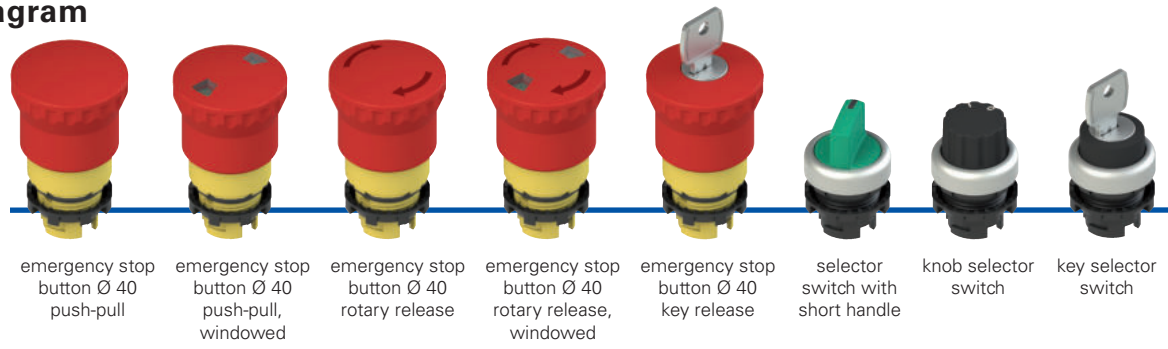

emergency stop button Ø 40 push-pull emergency stop button Ø 40 push-pull, windowed emergency stop button Ø 40 rotary release emergency stop button Ø 40 rotary release, windowed emergency stop button Ø 40 key release selector switch with short handle knob selector switch key selector switch

ACCESSORIES

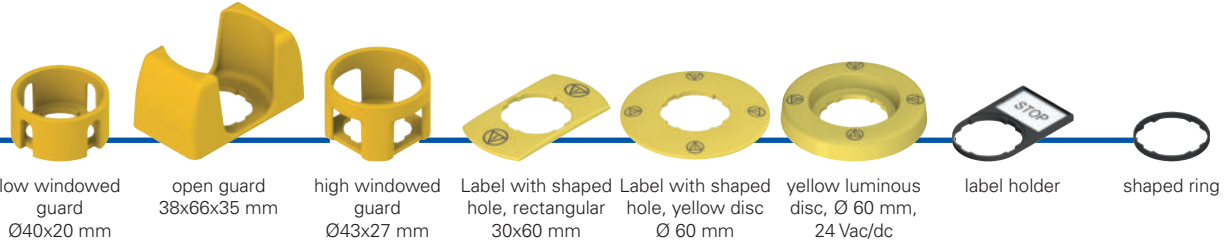

low windowed guard Ø40x20 mm open guard 38x66x35 mm high windowed guard Ø43x27 mm Label with shaped hole, rectangular 30x60 mm Label with shaped hole, yellow disc Ø 60 mm yellow luminous disc, Ø 60 mm, 24 Vac/dc label holder shaped ring

COVERS

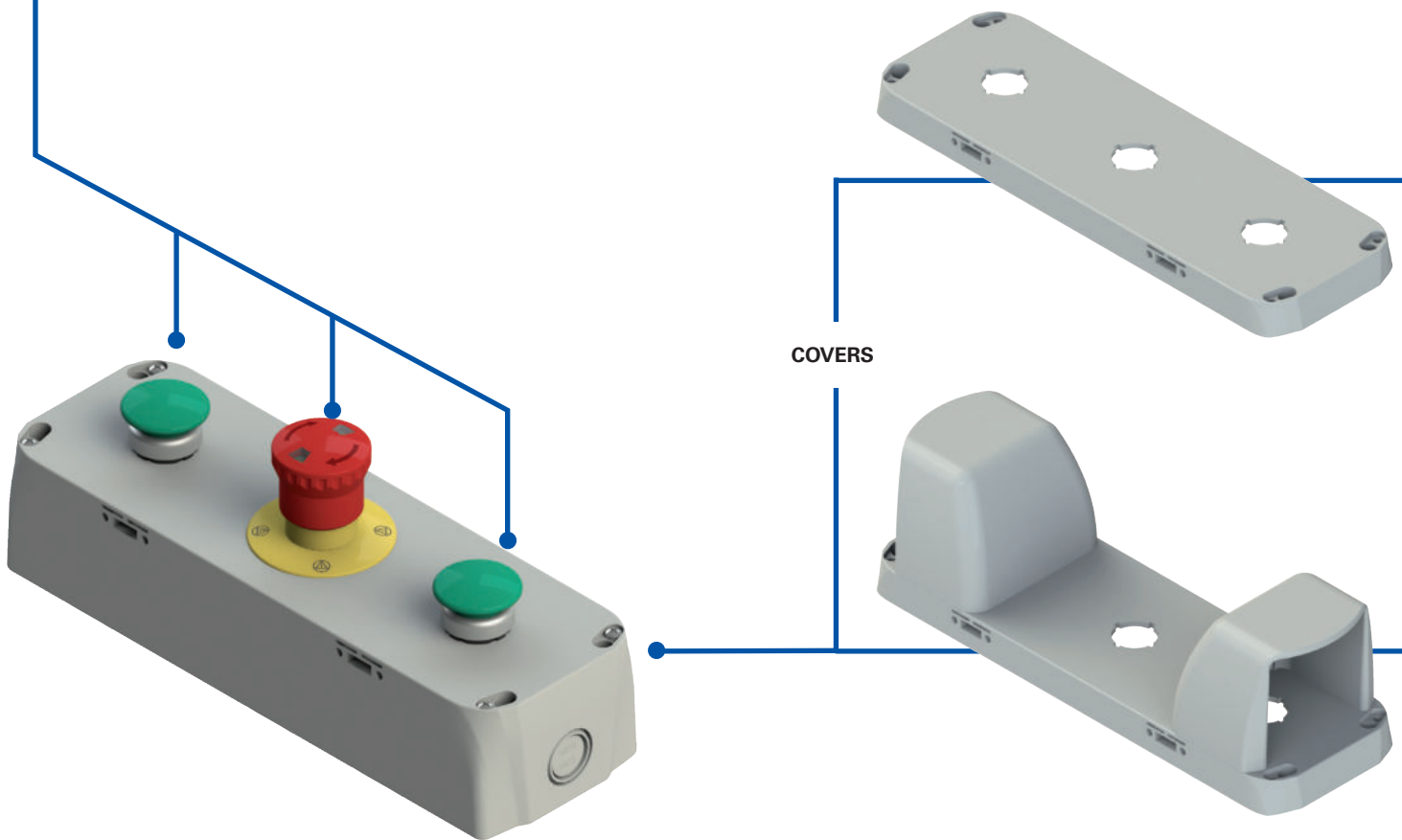

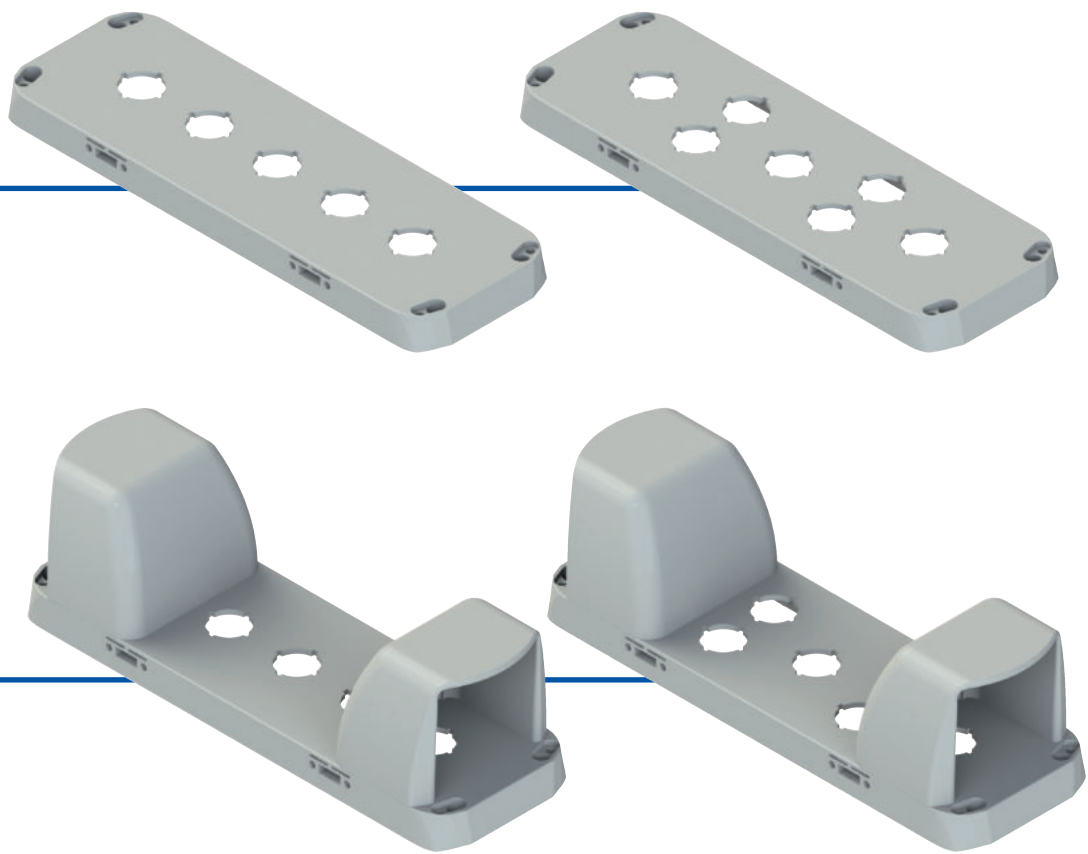

Code structure **Attention!** The feasibility of a code number does not mean the effective availability of a product. Please contact our sales office.

EA 37010

| | |
|--------------------------------------|----------------------------------|
| Body material | Configuration |
| 3 polycarbonate PC (standard) | 010 grey base, grey cover |
| Housing dimensions | ... |
| 7 280x90 mm | ... |

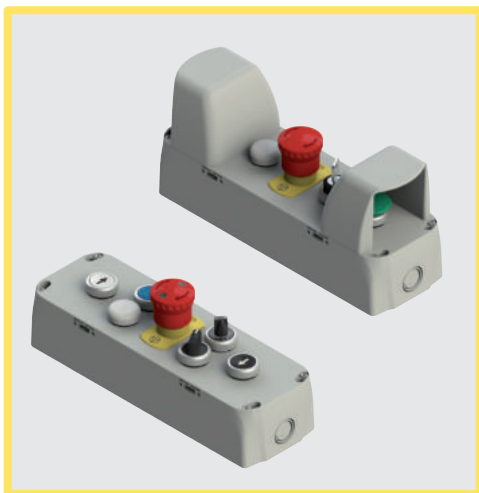

Main features

- Protection degree IP65
- Stainless steel captive screws
- 2 x side cable entries + 2 x bottom cable entries

Quality marks:



EAC approval:
UL approval:

RU C-IT.YT03.B.00035/19
E131787

Technical data

Housing

| | |
|---------------------------|--|
| Material: | Self-extinguishing shock-proof polycarbonate with double insulation, UV-resistant and glass fibre reinforced, high shock resistance. |
| Material of the screws: | Stainless steel |
| Protection degree: | IP65 acc. to EN 60529 (with cable gland of equal or higher protection degree) |
| Conduit entries: | 2 x M20 – M25 - 1/2 NPT knock-out side entries 2 x M20 – M25 - 1/2 NPT knock-out base entries |
| Device installation: | Suitable for the installation of Ø 22 mm control and signalling devices Ø 22 mm hole acc. to EN 60947-5-1 |
| Utilization requirements: | see page 169 |

For a correct operation in compliance with standard EN ISO 13851, the two-hand controls must be connected to a safety module for two-hand control safety device CS DM●●●●●. See Pizzato Elettrica's General Catalogue Safety.

General data

| | |
|--|-----------------|
| Ambient temperature: | -40°C ... +80°C |
| Tightening torque of the cover screws: | 1 ... 1.4 Nm |

In compliance with standards:

IEC 60947-1, IEC 60947-5-1, EN ISO 13851, IEC 60204-1, EN 60947-1, EN 60947-5-1, EN 60204-1, EN IEC 63000.

Compliance with the requirements of:

Low Voltage Directive 2014/35/EU,
EMC Directive 2014/30/EU,
RoHS Directive 2011/65/EU.

Features approved by UL

- The Tightening Torque value of cover screws: "Torque 1-1.4 Nm".
- The enclosed control box series ES and EA can be provided empty (without actuators and contact blocks) or equipped with actuators and contact blocks
- Empty version of Enclosed Control Stations ES and EA are already provided of holes for actuators
- Enclosed Control Stations ES and EA cannot be provided of mushroom actuators equipped with red head and yellow background
- Enclosed Control Stations ES and EA provided with yellow cover are not suitable for use with mushroom actuator with red head
- The Enclosed Control Stations ES and EA are suitable for conduit connection only
- For the enclosed control box series ES, the hub is to be connected to the conduit before the hub is connected to the enclosure
- For polymeric Enclosures that are intended for field assembly of the bonding means shall be located where visible during installation, such as inside the cover, and consist of the word "CAUTION" and the following or the equivalent: "Bonding between conduit connections is not automatic and must be provided as a part of the installation"; or the word "CAUTION" and the following or equivalent: "Nonmetallic enclosure does not provide grounding between conduit connection. Use grounding bushings and jumper wires".
- The maximum number of contact block for each hole of the Enclosed Control Stations ES and EA is 4
- The illuminated disk VE DL series as polymeric component assembled to Enclosed Control Stations ES and EA covers a hole of 5,5 mm diameter

General data

Fixing of EROUND housings

The new housings of the EROUND line by Pizzato Elettrica have 4 additional holes on the cover. The holes enable wall fixing from the outside by means of insertion of the screws, without the need to open the cover to access the holes.
The external fixing of the housing is therefore particularly suited for already wired enclosures.

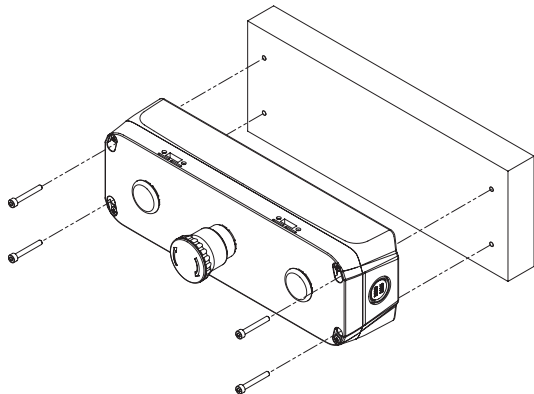

Wiring through the lower surface

Housings have 2 conduit entries on the lower surface. Cables can be connected via this surface, hiding them from view.

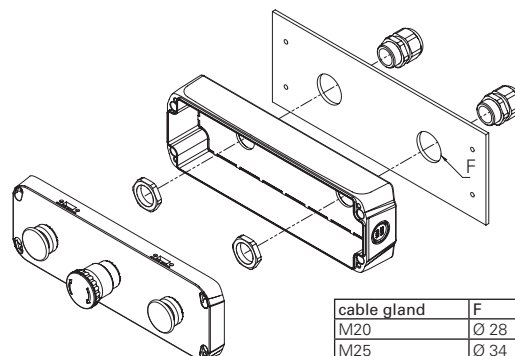

Selection table for housings



| Colour | Article | Ø 22 mm hole |
|--|----------|--------------|
|  grey RAL 7035 | EA 37014 | 3 |



| Colour | Article | Ø 22 mm hole |
|--|----------|--------------|
|  grey RAL 7035 | EA 37015 | 3 |



| Colour | Article | Ø 22 mm hole |
|--|----------|--------------|
|  grey RAL 7035 | EA 37010 | 5 |



| Colour | Article | Ø 22 mm hole |
|--|----------|--------------|
|  grey RAL 7035 | EA 37011 | 5 |



| Colour | Article | Ø 22 mm hole |
|--|----------|--------------|
|  grey RAL 7035 | EA 37012 | 7 |



| Colour | Article | Ø 22 mm hole |
|--|----------|--------------|
|  grey RAL 7035 | EA 37013 | 7 |

Complete control device units EA AC37***

EA AC37040

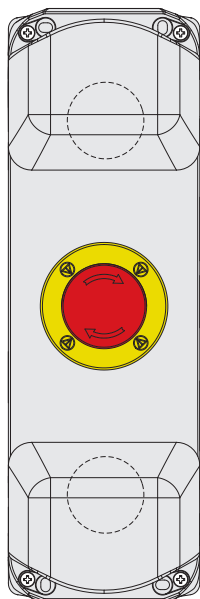

| Description | Features | | | Diagram |
|--|-------------------------------------|-----------------|-------------|---------|
| Mushroom button - 1NO E2 1PU2F4490 Guard VE GG3AA9A Contacts 1x E2 CP10G2V1 | spring-return, green | | | |
| | pos. 2 / | pos. 3 1NO | pos. 1 / | |
| Emergency stop button Ø 40 - 1NC E2 1PERZ4531 Label VE TF32A5113 Contacts 1x E2 CP01G2V1 | rotary release, 40 mm diameter, red | | | |
| | pos. 2 / | pos. 3 1NC ⊖ | pos. 1 / | |
| Mushroom button - 1NO E2 1PU2F4490 Guard VE GG3AA9A Contacts 1x E2 CP10G2V1 | spring-return, green | | | |
| | pos. 2 / | pos. 3 1NO | pos. 1 / | |

For IIIA-cat. two-hand controls acc. to EN ISO 13851, combine with safety module or safety PLC.
See Pizzato Elettrica's General Catalogue Safety.

EA AC37041

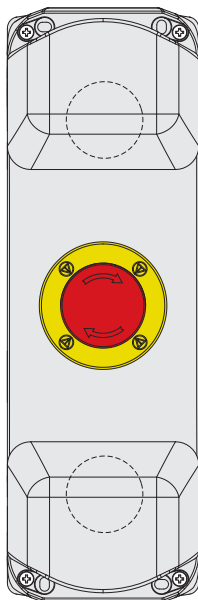

| Description | Features | | | Diagram |
|--|-------------------------------------|---------------|-----------------|---------|
| Mushroom button - 1NO+1NC E2 1PU2F4490 Guard VE GG3AA9A Contacts E2 CP10G2V1 + E2 CP01G2V1 | spring-return, green | | | |
| | pos. 2 / | pos. 3 1NO | pos. 1 1NC ⊖ | |
| Emergency stop button Ø 40 - 2NC E2 1PERZ4531 Label VE TF32A5113 Contacts 2x E2 CP01G2V1 | rotary release, 40 mm diameter, red | | | |
| | pos. 2 1NC ⊖ | pos. 3 / | pos. 1 1NC ⊖ | |
| Mushroom button - 1NO+1NC E2 1PU2F4490 Guard VE GG3AA9A Contacts E2 CP10G2V1 + E2 CP01G2V1 | spring-return, green | | | |
| | pos. 2 / | pos. 3 1NO | pos. 1 1NC ⊖ | |

For IIIC-cat. two-hand controls acc. to EN ISO 13851, combine with safety module or safety PLC.
See Pizzato Elettrica's General Catalogue Safety.

Dimensional drawings

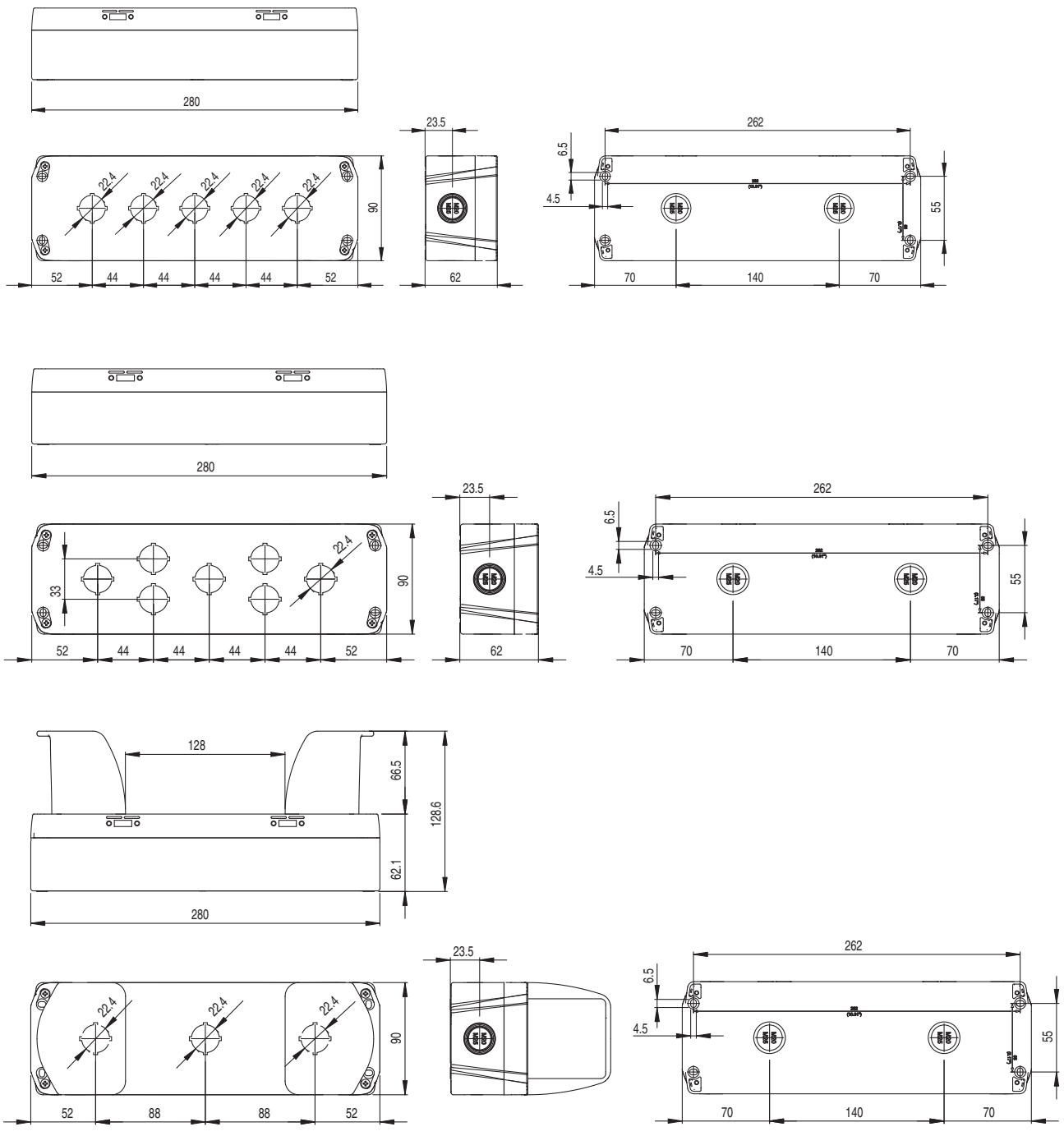

All values in the drawings are in mm

→ The 2D and 3D files are available at www.pizzato.com

Selection diagram

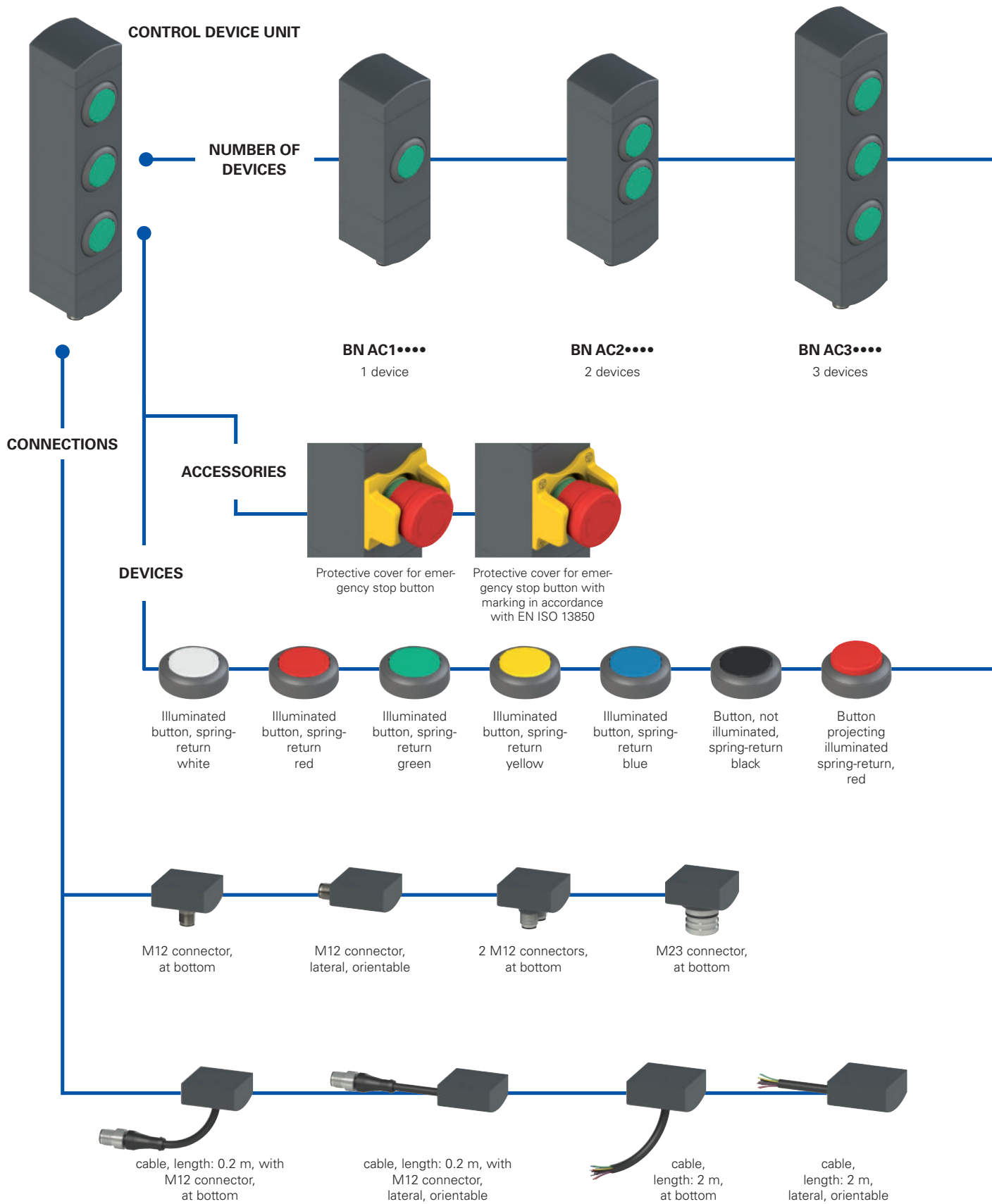

● product option
 → Sold separately as accessory

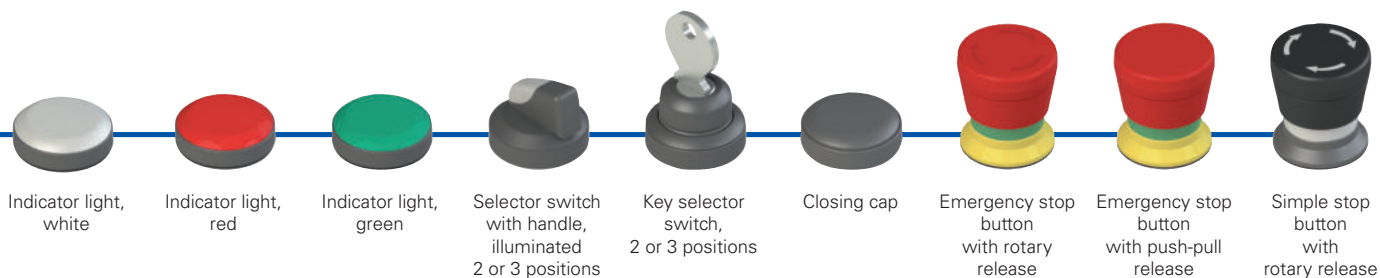
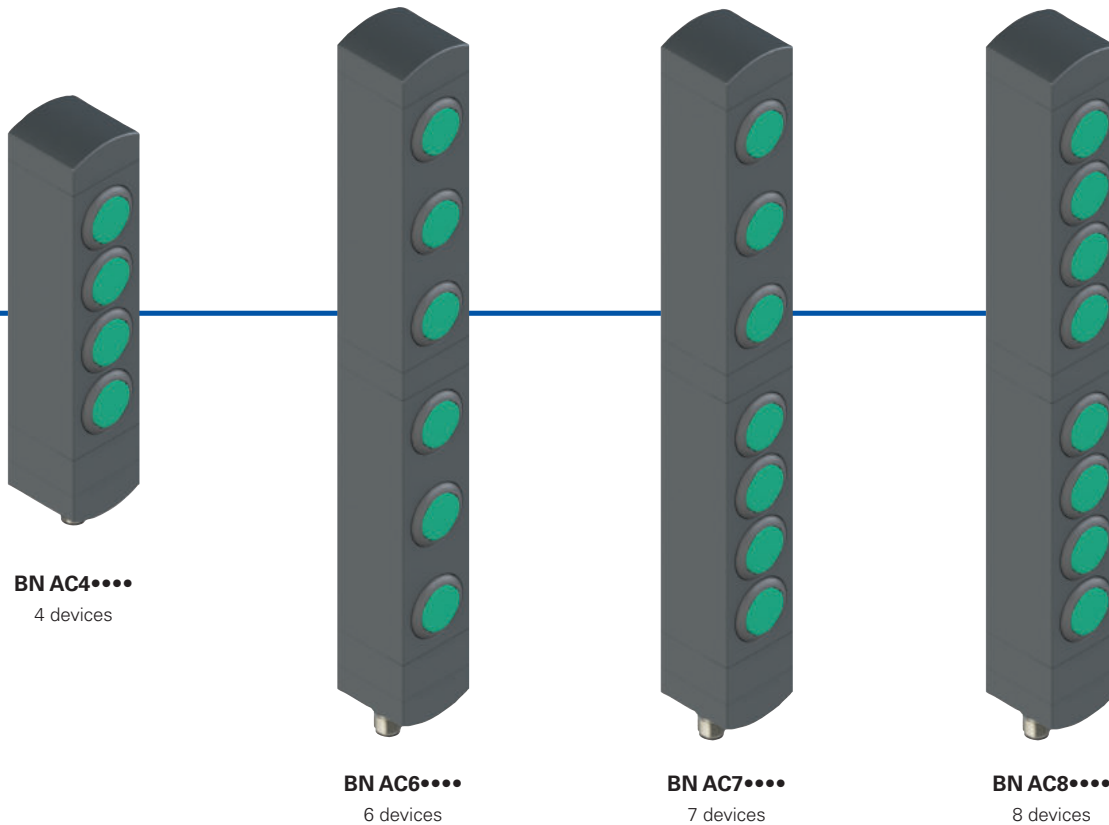

Code structure **Attention!** The feasibility of a code number does not mean the effective availability of a product. Please contact our sales office.

BN AC3ZA01

| Number of devices | |
|-------------------|-----------|
| 1 | 1 device |
| 2 | 2 devices |
| 3 | 3 devices |
| 4 | 4 devices |
| 6 | 6 devices |
| 7 | 7 devices |
| 8 | 8 devices |

| Button configuration | |
|----------------------|---------------------------------|
| A01 | A01 configuration |
| A02 | A02 configuration |
| A03 | A03 configuration |
| ... | other configurations on request |

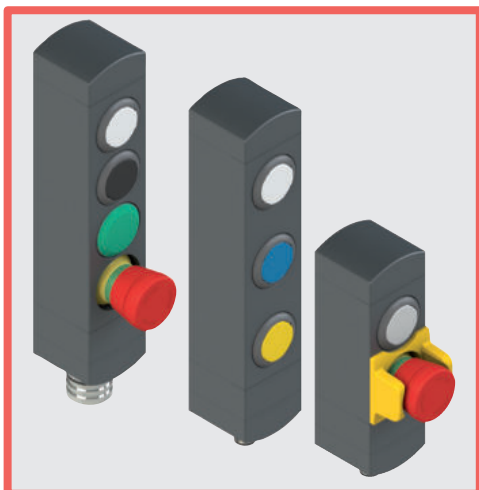

Main features

- Modular control device unit for 1 to 8 devices
- Rotatable fixing position
- Flush-mounted control devices
- Compact dimensions, minimal housing width
- Numerous control devices available

Quality marks:



UL approval: E131787

Features approved by UL

Electrical ratings: 24 Vdc Class 2, 0,1 A
Model BN with base module dimensions 40 mm by 38.5 mm by 145.5 mm:

Input Supplied by 24 Vdc, Class 2 Source or limited voltage limited energy, 0,096 A max. (Maximum eight leds).

Output 24 Vac/dc "Class 2" 0,25 A Pilot Duty (Maximum eight Actuators, with maximum twelve contacts, NO or NC or both) or 0,18 A Pilot Duty (Maximum eight Actuators, with maximum sixteen contacts, NO or NC or both)

Model BN with base module dimensions 40 mm by 38.5 mm by 82.1 mm:

Input Supplied by 24 Vdc, Class 2 Source or limited voltage limited energy, 0,048 A max. (Maximum four leds).

Output 24 Vac/dc "Class 2" 0,25 A Pilot Duty (Maximum four Actuators, with maximum eight contacts, NO or NC or both) or 0,18 A Pilot Duty (Maximum four Actuators, with maximum eight contacts, NO or NC or both)

Environmental ratings: Type 1

Technical data

Housing made of glass fibre reinforced technopolymer, self-extinguishing and shock-proof.
Versions with integrated cable 12 x 0.14 mm², length 2 m, other lengths from 0.5 m to 10 m on request.

Versions with integrated M23 or M12 stainless steel connector.

Versions with 2 integrated M12 stainless steel connectors.

Versions with 0.2 m cable and M12 connector, other lengths from 0.1 ... 3 m on request.

Protection degree: IP65 acc. to EN 60529

General data

| | |
|-------------------------------------|--|
| Ambient temperature: | -25°C ... +70°C |
| Fixing screws for the housing: | 2xM5, tightening torque 3 Nm |
| Fixing screws for turnable modules: | Tightening torque of 0.8 ... 1.2 Nm |
| Mechanical endurance: | |
| Spring-return button: | 1 million operating cycles |
| Emergency stop button: | 50,000 operating cycles |
| Selector switch: | 300,000 operating cycles |
| Key selector switch: | 50,000 operating cycles |
| | 30,000 operating cycles including removal of the key |
| Safety parameter B _{10D} : | 100,000 (emergency stop button) |

Actuating force:

| | | |
|------------------------|------------|-------------|
| Spring-return button: | 4 N min | 100 N max. |
| Emergency stop button: | 20 N min | 100 N max. |
| Selector switch: | 0.1 Nm min | 1.5 Nm max. |
| Key selector switch: | 0.1 Nm min | 1.3 Nm max. |

Electrical data of the devices

| | |
|--|---|
| Rated operating voltage U _e : | 24 Vdc ±10% SELV/PELV |
| Thermal current I _{th} : | 1 A |
| Rated insulation voltage U _i : | 32 Vac/dc |
| Rated impulse withstand voltage U _{imp} : | 1.5 kV |
| Material of the contacts: | silver contacts |
| Contact type: | Self-cleaning contacts with double interruption |
| Utilization category of the contact block: | DC-13; U _e = 24 V, I _e = 0.55 A |
| LED supply voltage: | 24 Vdc ±15% |
| Single LED supply current: | 12 mA |

M12 connector electrical data

| | |
|-------------------------|------------|
| Max. operating voltage: | 32 Vac/dc |
| Max. operating current: | 1.5 A max. |

M23 connector electrical data

| | |
|-------------------------|-----------|
| Max. operating voltage: | 32 Vac/dc |
| Max. operating current: | 3 A max. |

In compliance with standards:

IEC 60947-5-1, IEC 60947-5-5, EN ISO 13850, UL 508, CSA C22.2 No. 14.

Compliance with the requirements of:

Machinery Directive 2006/42/EC, Low Voltage Directive 2014/35/EU, EMC Directive 2014/30/EU, RoHS Directive 2011/65/EU.

⚠ Installation for safety applications:

Always connect the safety circuit to the NC contacts (normally closed contacts) as stated in standard EN 60947-5-1.

Actuation of the control devices from various directions

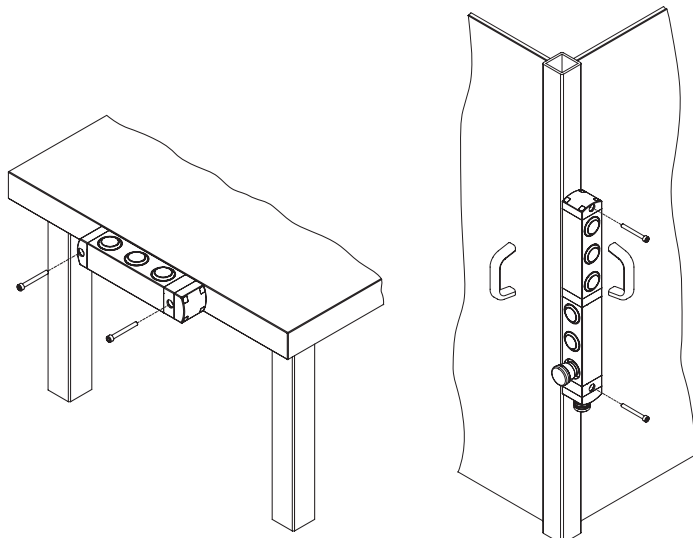

Thanks to the design with turnable modules, the control device units of the BN series offer the user many different options for fixing to the machine.

The orientation of the control devices can be selected independent of the fastening.

With the configurations for 6, 7 and 8 devices, the upper and lower part can be oriented independent of one another. This is especially useful if it should be possible to achieve a command state from two different sides of the machine. In these cases, a single device and single wiring harness can be used, thereby saving time and money.



General data



The new modular control device units of the BN series from Pizzato Elettrica can be combined perfectly with the RFID safety switches with lock of the NS series. Machine manufacturers who already use these products thereby have the possibility to attach a control device unit directly next to the safety switch that is identical in shape and dimensions.

The control device units of the BN series are available in configurations with 1 to 8 devices.

The unique design with individually turnable modules allows the user to select from a number of combinations. He receives a very versatile product that is immediately ready for use.

Compatibility with NS series switches

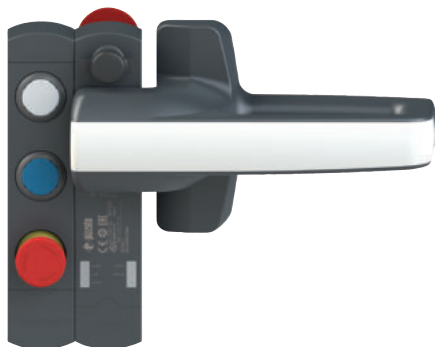

The control device units of the BN series have the same dimensions as the RFID safety switches with lock of the NS series. When mounted directly to the side of the switch, one obtains an integrated safety device whose components are made of the same material and have identical dimensions.

Minimal dimensions



One special feature of the control device units of the BN series is the slim thickness of just 40 mm.

The control devices are embedded in the housing of the unit and protrude only slightly out of the front.

This protects the control devices from unintended impacts, thereby increasing the service life of the devices and, at the same time, giving the devices an attractive design, making them predestined for use on modern machines in which this aspect is also given special consideration.

Turnable and non-detachable modules

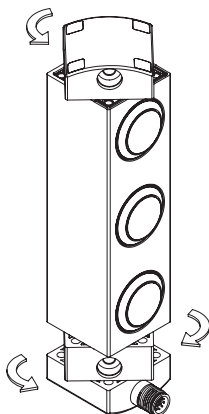

During installation, the fixing modules can be turned on the top and bottom of the device to enable variable orientation of the control devices.

Operation is very simple: after loosening the fixing screws, the device body can be turned in steps of 90° and fixed in the desired position. Another advantage for the installer is that the fixing modules cannot be detached from the device body. Disassembly of the individual parts is not necessary and there is no risk of losing parts or reassembling incorrectly.

Protection against tampering

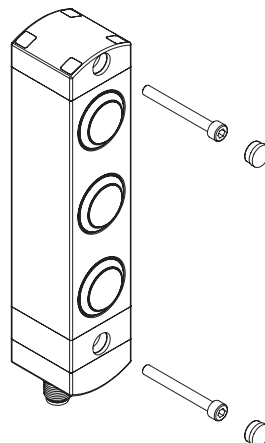

Each control device unit of the BN series is supplied complete with snap-on protection caps to be applied on the holes of the fixing screws. Not only do the caps prevent deposits of dirt from accumulating and simplify cleaning, they also prevent access to the fixing screws of the device, thereby offering increased protection against tampering.

Individually and freely configurable

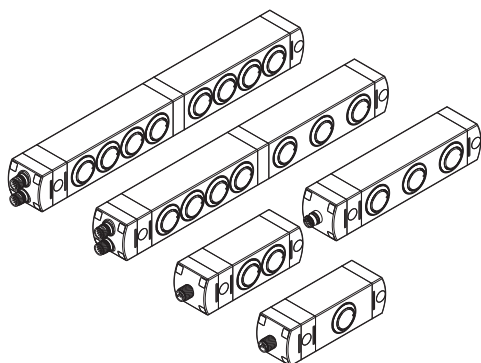

The control device unit is available in various configurations: for standard applications there are configurations with 1 to 4 devices, while configurations with 6, 7 or 8 devices are available for more complex applications that allow a larger number of control and signalling devices to be attached at the same location for the user.

Laser markable lenses



With all product configurations, a number of devices can be installed that can also be illuminated via LEDs integrated in the device.

The buttons are equipped with lenses that can be marked by laser for a resistant, indelible engraving. This allows you to customize the lenses with a wide range of text and symbols. For a complete list of available engravings, please refer to the tables on pp. 165-168.

Protection guard for emergency stop button



The mushroom-shaped emergency stop button can be combined with a yellow protection guard that serves to protect the device from shocks. The protection guard can also be provided with a laser marking in accordance with EN ISO 13850.

Examples of available configurations

BN AC1ZA12

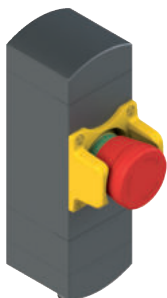

| | Description | Colour | Diagram |
|-----------|--|--------|---------|
| Device 1 | Emergency stop button with rotary release 2NC, with laser-marked protection guard | red | |
| Connector | M12, 5-pole at bottom | / | |

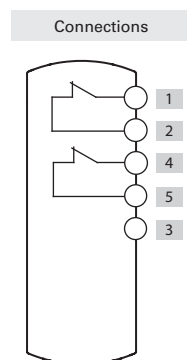

BN AC1ZA02



| | Description | Colour | Diagram |
|-----------|---|--------|---------|
| Device 1 | Illuminated button, spring-return 1NO | white | |
| Connector | M12, 5-pole, at bottom | / | |

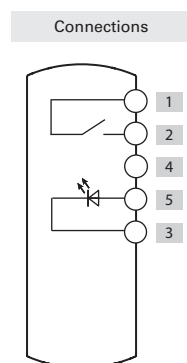

BN AC1ZA03



| | Description | Colour | Diagram |
|-----------|--|--------|---------|
| Device 1 | Illuminated selector switch with handle with two positions 1NO | black | |
| Connector | M12, 5-pole, at bottom | / | |

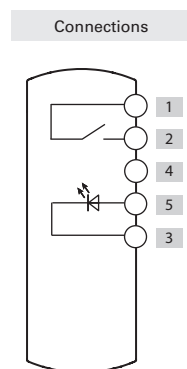

BN AC2ZA26

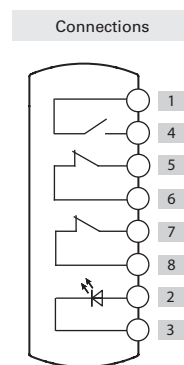
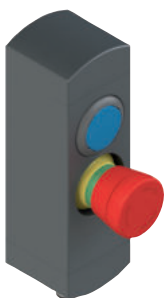

| | Description | Colour | Diagram |
|-----------|--|--------|---------|
| Device 1 | Illuminated button, spring-return 1NO | white | |
| Device 2 | Emergency stop button with rotary release 2NC, with protection guard | red | |
| Connector | M12, 8-pole, at bottom | / | |

BN AC2ZA02

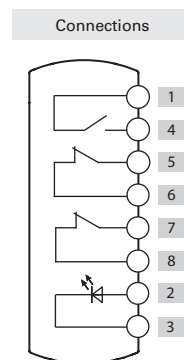
| | Description | Colour | Diagram |
|-----------|---|--------|---------|
| Device 1 | Illuminated button, spring-return 1NO | blue | |
| Device 2 | Emergency stop button with rotary release 2NC | red | |
| Connector | M12, 8-pole, at bottom | / | |

BN AC2ZA03

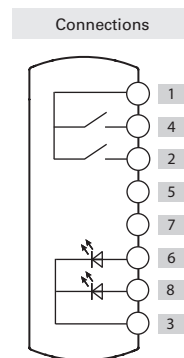

| | Description | Colour | Diagram |
|-----------|---------------------------------------|--------|---------|
| Device 1 | Illuminated button, spring-return 1NO | white | |
| Device 2 | Illuminated button, spring-return 1NO | blue | |
| Connector | M12, 8-pole, at bottom | / | |



BN AC3ZA01

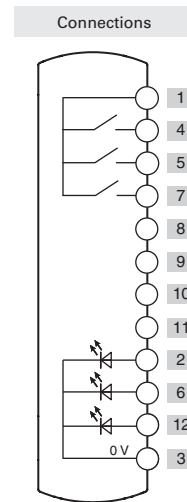

| | Description | Colour | Diagram |
|-----------|---------------------------------------|--------|---------|
| Device 1 | Illuminated button, spring-return 1NO | white | |
| Device 2 | Illuminated button, spring-return 1NO | blue | |
| Device 3 | Illuminated button, spring-return 1NO | yellow | |
| Connector | M12, 12-pole, at bottom | / | |



BN AC3ZB59



| | Description | Colour | Diagram |
|-----------|---|--------|---------|
| Device 1 | Illuminated button, spring-return 1NO | white | |
| Device 2 | Illuminated button, spring-return 1NO | blue | |
| Device 3 | Emergency stop button with rotary release 2NC, with laser-marked protection guard | red | |
| Connector | M12, 12-pole, at bottom | / | |

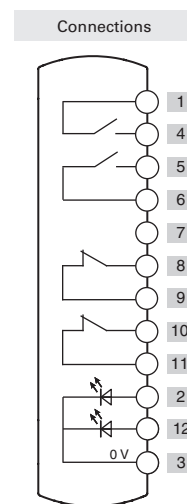

BN AC3ZA03



| | Description | Colour | Diagram |
|-----------|---|--------|---------|
| Device 1 | Illuminated button, spring-return 1NO | white | |
| Device 2 | Illuminated button, spring-return 1NO | yellow | |
| Device 3 | Emergency stop button with rotary release 2NC | red | |
| Connector | M12, 12-pole, at bottom | / | |

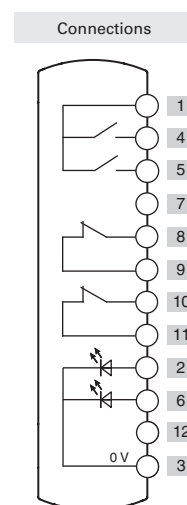

BN AC4ZA01

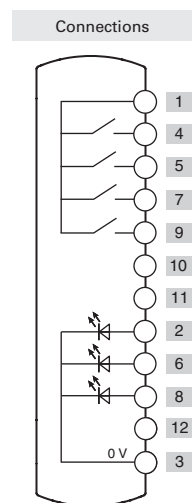
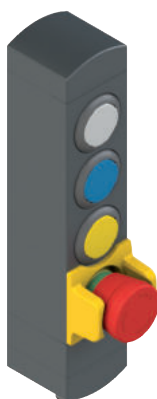

| | Description | Colour | Diagram |
|-----------|---------------------------------------|--------|---------|
| Device 1 | Illuminated button, spring-return 1NO | green | |
| Device 2 | Illuminated button, spring-return 1NO | red | |
| Device 3 | Illuminated button, spring-return 1NO | white | |
| Device 4 | Two-position key selector switch 1NO | black | |
| Connector | M12, 12-pole, at bottom | / | |

BN AC4ZB19

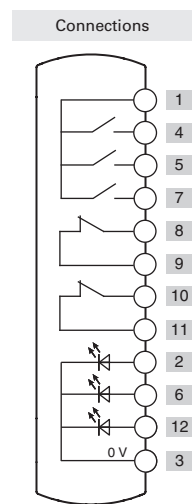
| | Description | Colour | Diagram |
|-----------|--|--------|---------|
| Device 1 | Illuminated button, spring-return 1NO | white | |
| Device 2 | Illuminated button, spring-return 1NO | blue | |
| Device 3 | Illuminated button, spring-return 1NO | yellow | |
| Device 4 | Emergency stop button with rotary release 2NC, with protection guard | red | |
| Connector | M12, 12-pole, at bottom | / | |

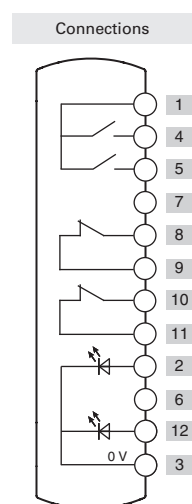

BN AC4ZA03

| | Description | Colour | Diagram |
|-----------|---|--------|---------|
| Device 1 | Illuminated button, spring-return 1NO | white | |
| Device 2 | Spring-return button 1NO | black | |
| Device 3 | Indicator light | green | |
| Device 4 | Emergency stop button with rotary release 2NC | red | |
| Connector | M23, 12-pole, at bottom | / | |

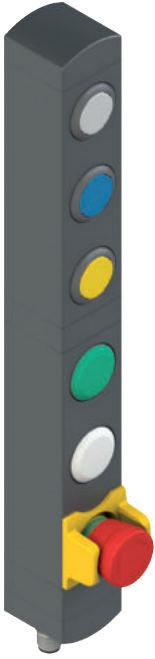

For pin assignments of the connectors, see page 156

BN AC6ZA40



| | Description | Colour | Diagram |
|-----------|--|--------|---------|
| Device 1 | Illuminated button, spring-return 1NO | white | |
| Device 2 | Illuminated button, spring-return 1NO | blue | |
| Device 3 | Illuminated button, spring-return 1NO | yellow | |
| Device 4 | Indicator light | green | |
| Device 5 | Indicator light | white | |
| Device 6 | Emergency stop button with rotary release 2NC, with protection guard | red | |
| Connector | Two M12, 12-pole, at bottom | / | |

Connections

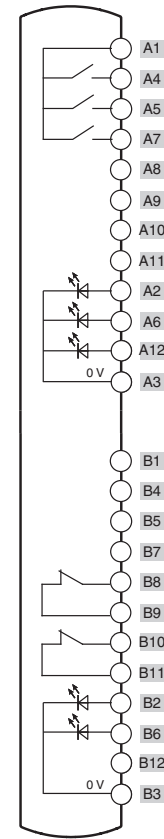

BN AC6ZA02

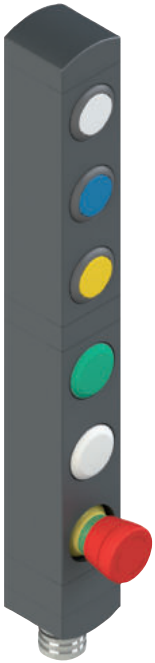

| | Description | Colour | Diagram |
|-----------|---|--------|---------|
| Device 1 | Illuminated button, spring-return 1NO | white | |
| Device 2 | Illuminated button, spring-return 1NO | blue | |
| Device 3 | Illuminated button, spring-return 1NO | yellow | |
| Device 4 | Indicator light | green | |
| Device 5 | Indicator light | white | |
| Device 6 | Emergency stop button with rotary release 2NC | red | |
| Connector | M23, 19-pole, at bottom | / | |

Connections

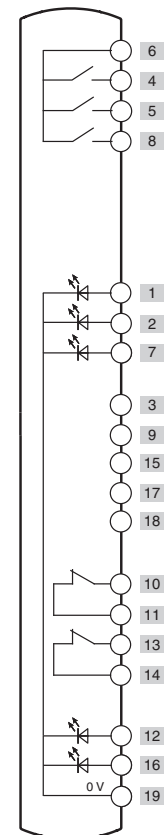



BN AC7ZA07



| | Description | Colour | Diagram |
|-----------|--|--------|---------|
| Device 1 | Two-position key selector switch 1NO | black | |
| Device 2 | Illuminated selector switch with handle with two positions 1NO | black | |
| Device 3 | Indicator light | green | |
| Device 4 | Illuminated button, spring-return 1NO | white | |
| Device 5 | Illuminated button, spring-return 1NO | blue | |
| Device 6 | Illuminated button, spring-return 1NO | yellow | |
| Device 7 | Emergency stop button with rotary release 2NC, with protection guard | red | |
| Connector | Two M12, 12-pole, at bottom | / | |

Connections

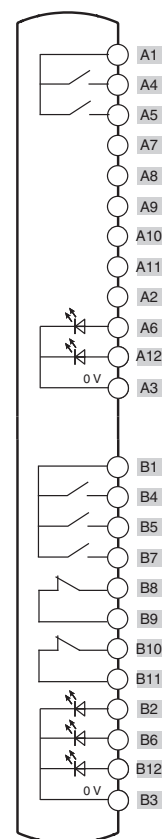

BN AC8ZA01







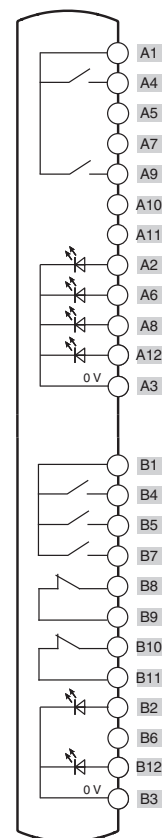







| | Description | Colour | Diagram |
|-----------|--|--------|---------|
| Device 1 | Illuminated selector switch with handle with two positions 1NO | black | |
| Device 2 | Indicator light | red | |
| Device 3 | Indicator light | green | |
| Device 4 | Illuminated button, spring-return 1NO | yellow | |
| Device 5 | Illuminated button, spring-return 1NO | white | |
| Device 6 | Spring-return button 1NO | black | |
| Device 7 | Illuminated button, spring-return 1NO | blue | |
| Device 8 | Emergency stop button with rotary release 2NC | red | |
| Connector | Two M12, 12-pole, at bottom | / | |

Connections

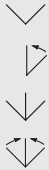

For pin assignments of the connectors, see page 156

Spare devices available

| | Description | Colour | Article | Combinable with contacts ⁽¹⁾ | Protrusion (x) mm |
|--|---|---|---|---|-------------------|
|  | Illuminated button, spring-return | <ul style="list-style-type: none"> ● White ● Red ● Green ● Yellow ● Blue | VN NG-AC27121 VN NG-AC27123 VN NG-AC27124 VN NG-AC27125 VN NG-AC27126 | 1NO (1NC) (2NO) (1NO+1NC) | 3 |
|  | Non-illuminated button, spring-return | ● Black | VN NG-AC27122 | 1NO (1NC) (2NO) (1NO+1NC) | 3 |
|  | Non-laser-markable, illuminated, projecting push button ⁽²⁾ | ● Red | VN NG-AC26018 | 1NO (1NC) (2NO) (1NO+1NC) | 6,1 |
|  | Indicator light | <ul style="list-style-type: none"> ● Red ● Yellow ● Green ● Blue ● White | VN NG-AC26060 VN NG-AC26061 VN NG-AC26062 VN NG-AC26063 VN NG-AC26064 | / | 2,7 |
|  | Emergency stop button acc. to EN ISO 13850 Rotary release Push-pull release | <ul style="list-style-type: none"> ● Red ● Red | VN NG-AC26052 VN NG-AC26055 | 2NC | 26,4 |
|  | EN ISO 13850-compliant emergency pushbutton for 2NC+1NO pulse contacts ⁽³⁾ Rotary release | ● Red | VN NG-AC26056 | 2NC + 1NO pulse | 26,4 |
|  | Illuminated emergency stop button acc. to EN ISO 13850 Rotary release Push-pull release | <ul style="list-style-type: none"> ● Red ● Red | VN NG-AC26051 VN NG-AC26054 | 2NC | 26,4 |
|  | Simple stop button Rotary release Push-pull release | <ul style="list-style-type: none"> ● Black ● Black | VN NG-AC26053 VN NG-AC26057 | 2NC | 26,4 |
|  | Illuminated selector switch with handle with 2 or 3 positions and transparent lens for LED  | <ul style="list-style-type: none"> ● Black ● Black ● Black ● Black | VN NG-AC26033 VN NG-AC26030 VN NG-AC26034 VN NG-AC26031 | 1NO (1NC) (2NO) (1NO+1NC) | 16,8 |
|  | Key selector switch, 2 or 3 positions  | <ul style="list-style-type: none"> ● Black ● Black ● Black | VN NG-AC26043 VN NG-AC26040 VN NG-AC26041 | 1NO (1NC) (2NO) (1NO+1NC) | 39 (a) 14 (b) |
|  | Closing cap | ● Black | VN NG-AC26020 | / | 2,7 |
|  | Fixing key | ● Black | VN NG-AC26080 | / | / |

Legend:  Maintained  Spring-return  Key extraction position (a) with key (b) without key

⁽¹⁾ The contacts in brackets are on request. Contact our technical department to verify the effective feasibility of the control panel with the chosen combination of control devices.

⁽²⁾ The projecting buttons are not laser markable.

⁽³⁾ The pulse NO contact is activated only when the emergency button reaches the bottom of the stroke. The NO contact signal should be detected by analyzing the rising edge.

To order buttons with marking:

add the marking code indicated in the tables on pp. 165-168 to the article codes.

Example: Black spring-return button with "O" engraving.

VN NG-AC27122 → VN NG-AC27122-L1



Technical data of the control devices

General data

| | |
|------------------------------|--|
| Protection degree: | IP65 acc. to EN 60529 |
| Mechanical endurance: | |
| Spring-return button: | 1 million operating cycles |
| Emergency stop button: | 50,000 operating cycles |
| Selector switch: | 300,000 operating cycles |
| Key selector switch: | 50,000 operating cycles |
| | 30,000 operating cycles including removal of the key |
| Safety parameter B_{10D} : | 100,000 (emergency stop button) |

Actuating force

| | | |
|------------------------|------------|-------------|
| Spring-return button: | 4 N min | 100 N max. |
| Emergency stop button: | 20 N min | 100 N max. |
| Selector switch: | 0.1 Nm min | 1.5 Nm max. |
| Key selector switch: | 0.1 Nm min | 1.3 Nm max. |

Contact blocks of the control devices

| | |
|---------------------------|---|
| Material of the contacts: | silver contacts |
| Contact type: | Self-cleaning contacts with double interruption |

Electrical data:

| | |
|---|------------------|
| Thermal current I_{th} : | 1 A |
| Rated insulation voltage U_i : | 32 Vac/dc |
| Rated impulse withstand voltage U_{imp} : | 1.5 kV |
| LED supply voltage: | 24 Vdc \pm 15% |
| LED supply current: | 10 mA per LED |

Utilization category of the contact block:

| |
|----------------------|
| Direct current: DC13 |
| U_e (V) 24 |
| I_e (A) 0.55 |

Signalling contact with spring return:

| |
|----------------------|
| Direct current: DC13 |
| U_e (V) 24 |
| I_e (mA) 10 |

In compliance with standards:

IEC 60947-5-1, IEC 60947-5-5, EN ISO 13850

Installation for safety applications:

Always connect the safety circuit to the **NC contacts** (normally closed contacts) as stated in standard EN 60947-5-1.

Dimensional drawings

BN AC1••••

BN AC2••••

BN AC3••••

BN AC4••••

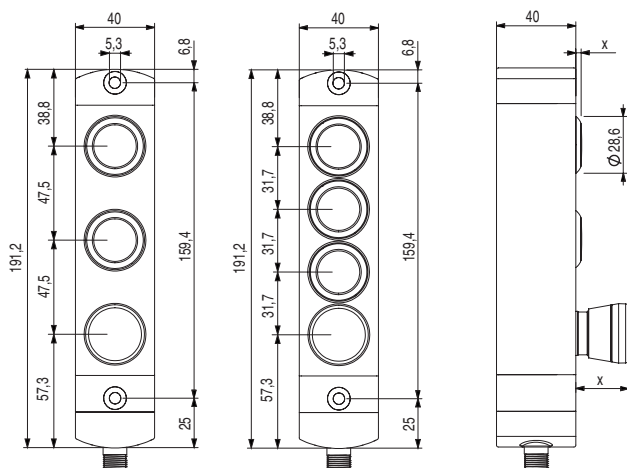
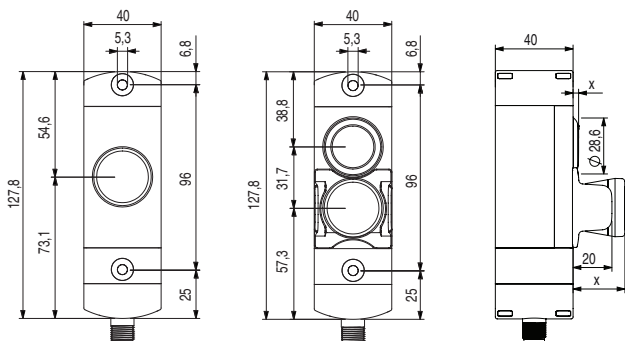

BN AC6••••

BN AC7••••

BN AC8••••

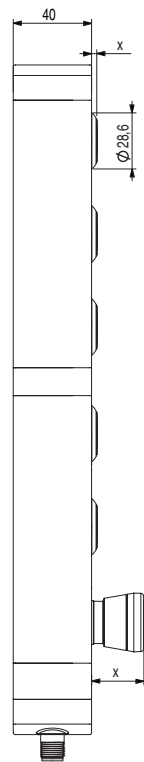
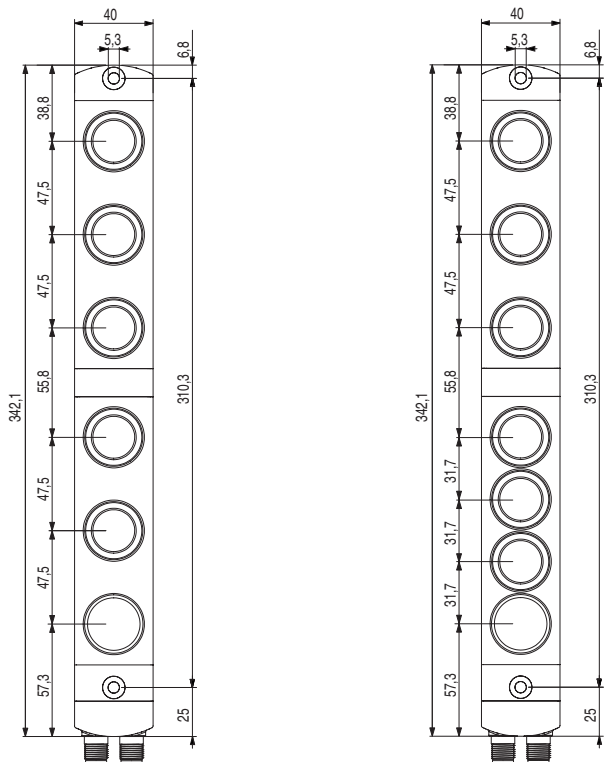

Output type

M12 connector, at bottom

M12 connector, lateral

Two M12 connectors, at bottom

M23 connector, at bottom

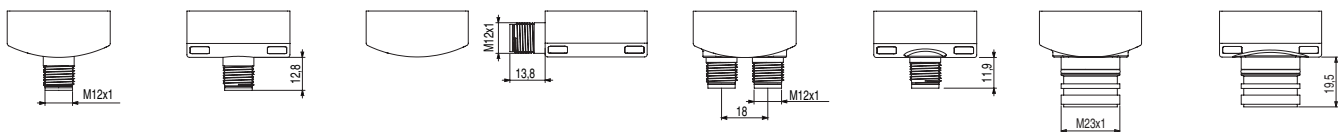

All values in the drawings are in mm

→ The 2D and 3D files are available at www.pizzato.com



Electrical connections

M12 connector, 5-pole

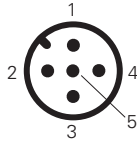

M12 connector, 8-pole

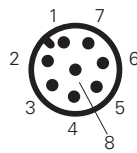

Cable

| Pin No. | Cable colour | Pin No. | Cable colour |
|---------|--------------|---------|--------------|
| 1 | brown | 7 | black |
| 2 | blue | 8 | grey |
| 3 | white | 9 | red |
| 4 | green | 10 | purple |
| 5 | pink | 11 | grey-pink |
| 6 | yellow | 12 | red-blue |

M12 connector, 12-pole

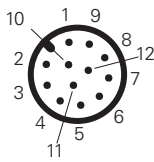

Two M12 connectors, 12-pole

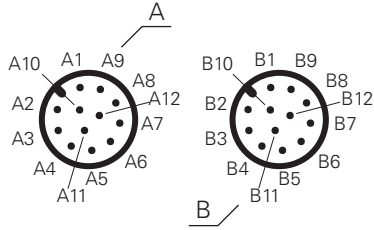

M23 connector, 12-pole

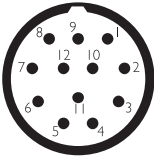

M23 connector, 19-pole

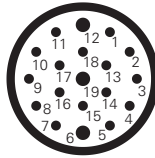

Selection diagram

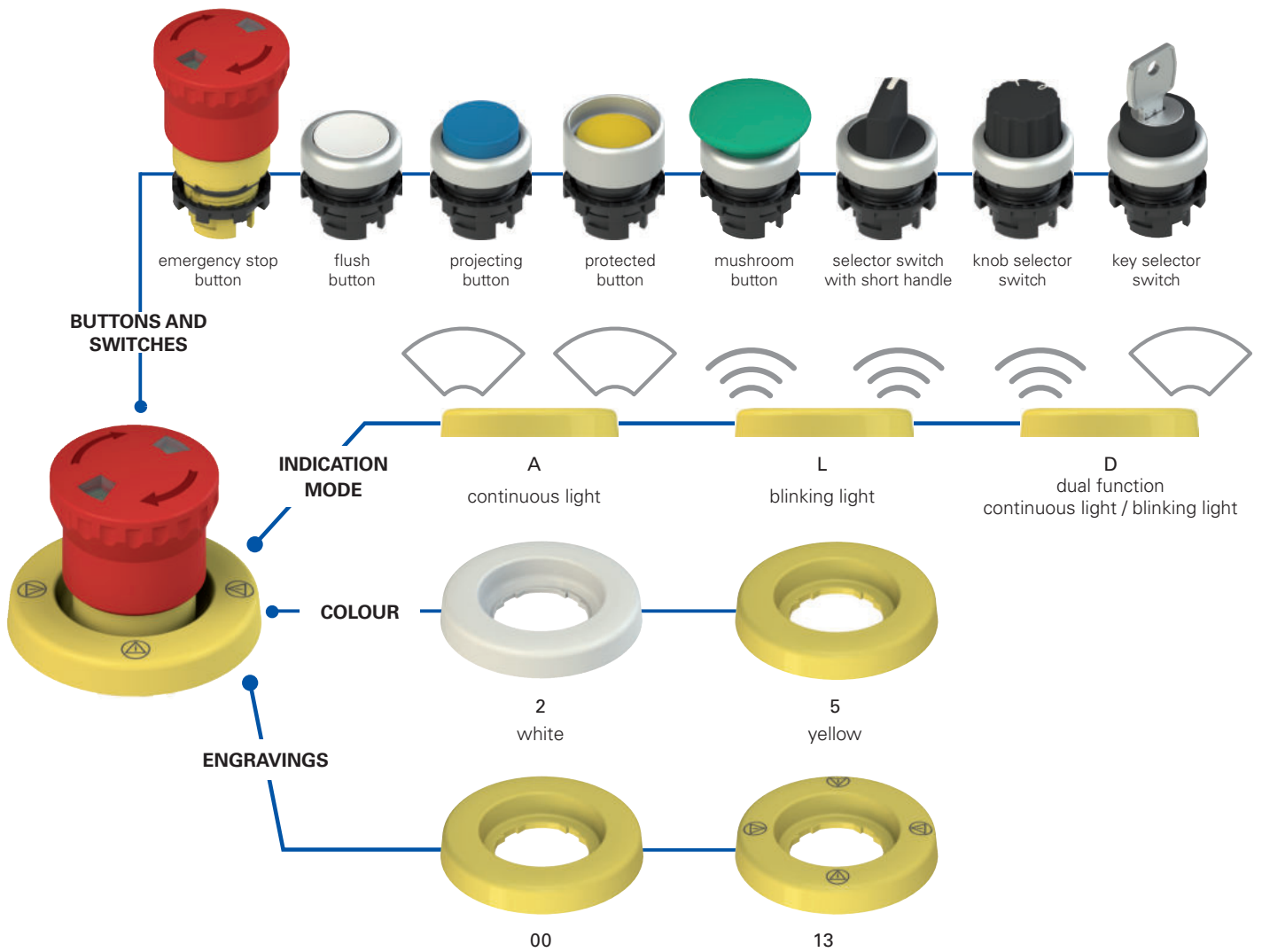

Code structure

Attention! The feasibility of a code number does not mean the effective availability of a product. Please contact our sales office.

VE DL1A5A00

| Supply voltage | |
|----------------|-----------|
| 1 | 24 Vac/dc |
| 5 | 12 Vac/dc |

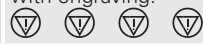
| Engraving | |
|-----------|---|
| 00 | without engraving |
| 13 | with engraving:  |

Other engravings on request.

| Colour | |
|--------|--------|
| 2 | white |
| 5 | yellow |

| Indication mode | |
|-----------------|--|
| A | continuous light |
| L | blinking light |
| D | dual function continuous light / blinking light |



Main features

- High visibility
- Protection degree IP67
- Compact design
- Indelible laser engraving
- Customisable engravings
- Continuous, blinking or dual function light

Quality marks:



EAC approval: RU C-IT.YT03.B.00035/19
 UL approval: E131787

Technical data

General data

| | |
|--|--|
| Protection degree: | IP67 acc. to EN 60529 (applied with the supplied adhesive) |
| Ambient temperature: | -25°C ... +70°C |
| Cable cross section: | 0.25 mm ² (AWG 24) |
| Cable laying: | fixed |
| Cable minimum bending radius: | 14 mm |
| Cable insulation: | PVC |
| Operating voltage U _e : | 12 Vac/dc or 24 Vac/dc |
| Operating voltage tolerance: | ±15% of U _e |
| Operating current at U _e voltage: | 65 mA (12 Vac/dc version) 25 mA (24 Vac/dc version) |
| Blinking frequency (if present): | 1 Hz |
| Utilization requirements: | see page 169 |

In compliance with standards:

IEC 60947-1, IEC 60947-5-1, IEC 60204-1, EN 60947-1, EN 60947-5-1, EN 60204-1, EN IEC 63000.

Compliance with the requirements of:

Low Voltage Directive 2014/35/EU,
 EMC Directive 2014/30/EU,
 RoHS Directive 2011/65/EU.

General data

Continuous or blinking light



The luminous disc can be supplied with two different lighting modes: continuous or blinking light. The blinking light versions allow a faster identification on the panel of the lit device compared to the continuous light. The internal electronic circuit autonomously alternates the ON and OFF phases without requiring any special electrical connection.

The luminous disc can be supplied with two different lighting modes: continuous or blinking light. The blinking light versions allow a faster identification on the panel of the lit device compared to the continuous light. The internal electronic circuit autonomously alternates the ON and OFF phases without requiring any special electrical connection.

Dual function luminous disc



This version of the luminous disc enables the device to be lit with a continuous or blinking light using a simple wiring system. The dual function luminous disc is fitted with three wires: depending on the electrical connection, the light can be continuous or blinking.

Depending on the electrical connection, the light can be continuous or blinking.

Sticking

The luminous disc can also be installed using the supplied adhesive: simply remove the adhesive protective film placed under the disc. Thanks to this sticking, it is possible to get the perfect adhesion to the surface and the IP67 protection degree.

Customisable



In order to satisfy various customer requests and demands, Pizzato Elettrica offers the possibility to customize the luminous discs with engravings that are extremely visible thanks to the uniform lightning of the device.

High visibility

Thanks to internal high luminosity LEDs the emergency stop button can be immediately recognized and located. This ensures a safer use in scarcely illuminated environments, or when the device is placed at distance, or in case of scarce visibility.

The ideal way to highlight also normal buttons or selectors.

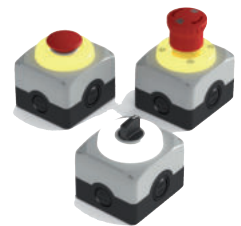

Protection degree IP67

IP67 These devices are designed to be used under the toughest environmental conditions, and they pass the IP67 immersion test acc. to EN 60529. They can therefore be used in all environments where the maximum degree of protection is required for the housing.

White lens version







The luminous disc can be purchased in the version with white lens and in the standard version with yellow lens. The white lens enables the luminous disc to make use of new signalling possibilities and also allows the device to be used as a point of light. The white lens version can also be personalised by way of laser engraving.

Features approved by UL

- VE DL5 models: 12 Vac/Vdc Class 2, 65 mA
 - VE DL1 models: 24 Vac/Vdc Class 2, 25 mA
 - Maximum Ambient Temperature: 40°C
 - Environmental rating: "For use on a Flat surface of a Type 1, 4, 4X Enclosure"
- The illuminated disk VE DL series as polymeric component assembled to Enclosed Control Stations ES and EA covers a hole of 5,5 mm diameter
 The illuminated disk VE DL series yellow version is not suitable for use with mushroom actuator with red head
 The illuminated disk VE DL series cannot be marked with words like "emergency," "emergency stop" or similar/equivalent
 The illuminated disk VE DL series cannot be marked with symbol like ⚡ or similar/equivalent

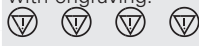
Selection table

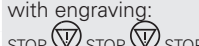
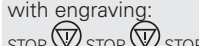
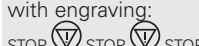
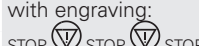
| Colour and engraving | Description | Type | Operating voltage | |
|---|--|------------------|-------------------|-------------|
| | | | 12 Vac/dc | 24 Vac/dc |
|  | Yellow luminous disc, Ø 60 mm, without engraving, acc. to ISO 13850 | continuous light | VE DL5A5A00 | VE DL1A5A00 |
| | | blinking light | VE DL5A5L00 | VE DL1A5L00 |
| | | dual function | VE DL5A5D00 | VE DL1A5D00 |
|  | Yellow luminous disc, Ø 60 mm, with engraving:  acc. to ISO 13850 | continuous light | VE DL5A5A13 | VE DL1A5A13 |
| | | blinking light | VE DL5A5L13 | VE DL1A5L13 |
| | | dual function | VE DL5A5D13 | VE DL1A5D13 |
|  | Yellow luminous disc, Ø 60 mm, with engraving: STOP  STOP  STOP  STOP  | continuous light | VE DL5A5A09 | VE DL1A5A09 |
| | | blinking light | VE DL5A5L09 | VE DL1A5L09 |
| | | dual function | VE DL5A5D09 | VE DL1A5D09 |

To purchase the white luminous disc replace number 5 with number 2 in the codes shown above. Example: VE DL1A5A00 → VE DL1A2A00

Electrical connection of the dual function luminous disc



| Cable colour | Description |
|--------------|-------------------------------|
| white (J1) | Blinking light power supply |
| grey (J2) | Power supply 0 V |
| yellow (J3) | Continuous light power supply |

Application example of the dual function luminous disc

It is possible to obtain a continuous or blinking light device depending on the wiring. For example, this opportunity can be exploited on a series of emergency stop buttons connected in chain formation (figure 1). The luminous disc can pass from the continuous light mode to the blinking light mode when the respective emergency stop button is pressed: this way the luminous disc of the selected emergency stop button begins to blink while all the others switch off, making it easy to identify the point where the emergency stop button was pressed (figure 2). Figure 3 indicates an example of the electrical diagram for the connection in series of three or more emergency stop buttons fitted with dual function luminous disc.

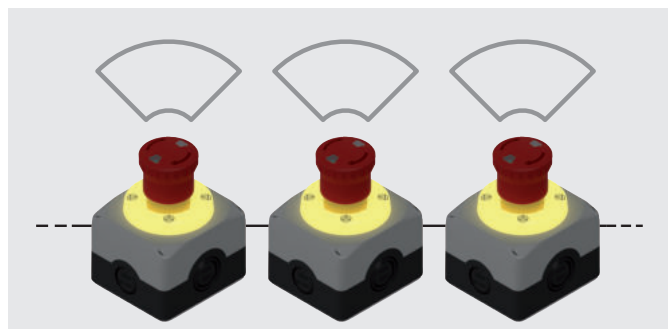

Figure 1

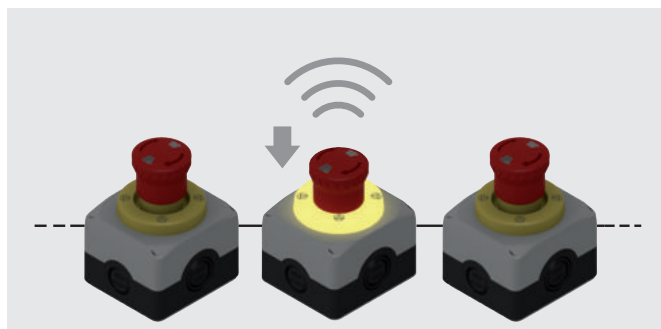

Figure 2

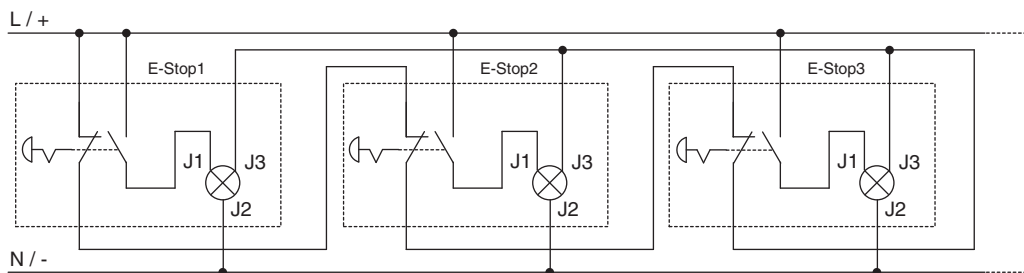
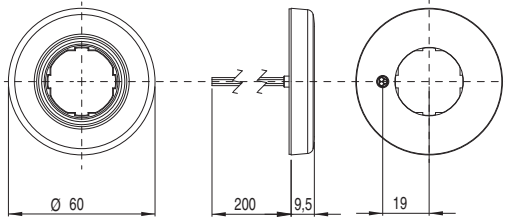
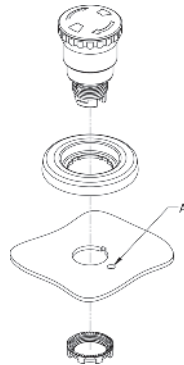
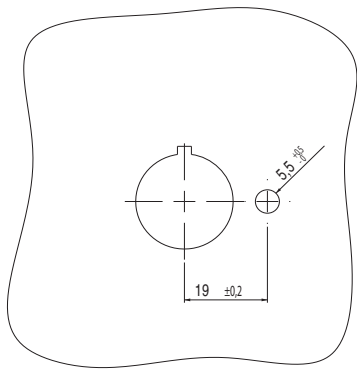

Figure 3

Dimensional drawings



Drilling and mounting



A: Cable feed-through

Minimum distances for installation

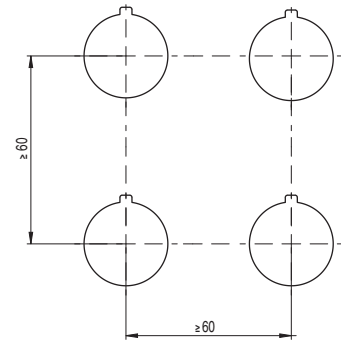

All values in the drawings are in mm

Connection block Packs of 10 pcs.



Connection blocks without electrical contacts and dimensions identical to those of the contact blocks. Fitted with two electrically separated terminals to enable the VE DL series luminous disc to be installed without any additional terminals or crimp connections.

| Article | Description |
|-----------|--|
| VE BC2PV1 | Connection block with 2 terminals on a panel |
| VE BC2FV1 | Connection block with 2 terminals on a base mounting |



Traditional wiring

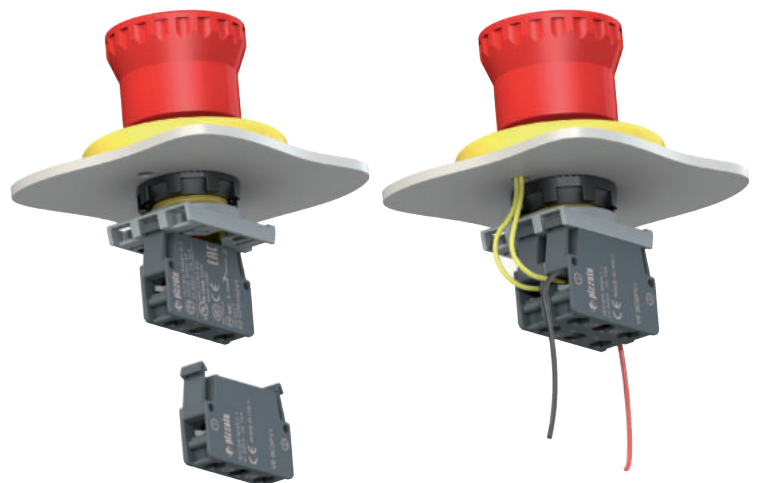

Wiring with connection block

Accessories

→ More ACCESSORIES on page 161

Fixing ring

Packs of 20 pcs.

| | Article | Description |
|---|-----------|---------------------------|
|  | VE GF121A | Technopolymer fixing ring |
|  | VE GF720A | Metal fixing ring |

Fixing key

| | Article | Description |
|---|------------|---|
|  | VE CH121A1 | Technopolymer fixing key for VE GF•••• fixing rings |

Ø 22 ... Ø 30 mm adapter

Packs of 10 pcs.

| Article | Description |
|-----------|---|
| VE GF151A | Adapter with ring for panel fixing for Ø 22 devices on Ø 30 holes compliant with EN 60947-5-1 |

Technical data:
 Body and ring material: technopolymer
 Protection degree: IP67 and IP69K
 Tightening torque: 2 ... 2.5 Nm
 Dowel can be removed with a simple screwdriver

Not applicable on E2 •PD•••••• - E2 •PT•••••• - E2 •PQ•••••• double, triple, and quadruple buttons. Not applicable in presence of shaped rings, label holders, guards or protection caps. It does not alter the IP protection degree of the associated device.

Mounting adapter

Packs of 10 pcs.

| Article | Description |
|-----------|---|
| E2 1BAC11 | 3-slot mounting adapter for E2 CP contact blocks and E2 LP LED units |
| E2 1BAC12 | 3-slot mounting adapter, oriented, for E2 CP contact blocks and E2 LP LED units |
| E2 1BAC21 | 4-slot mounting adapter for E2 CP contact blocks |
| E2 1BAC22 | 4-slot mounting adapter, oriented, for E2 CP contact blocks |

Not combinable with E2 •PQ•••••• quadruple buttons and E2 •MA•••••• joysticks.

Combinable only with selectors E2 •SE••••••, key selector switches E2 •SC••••••, buttons E2 •PU••••••, double buttons E2 •PD••••••, emergency stop buttons E2 •PE••••••, configured in the appropriate versions for 4-slot adapter.
 Combinable with E2 •PQ•••••• quadruple buttons and E2 •MA•••••• joysticks.

Adapter for DIN rail

Packs of 10 pcs.

| Article | Description |
|-------------|---|
| VE AD3PF9A0 | Support with Ø22 hole for fixing on DIN rail of the signalling and control devices of the EROUND line |

Patent pending

Not suitable for joysticks and quadruple buttons.

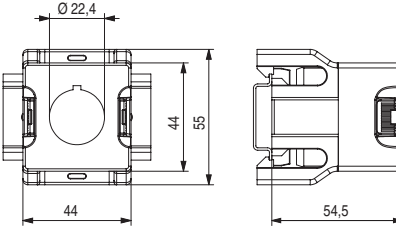
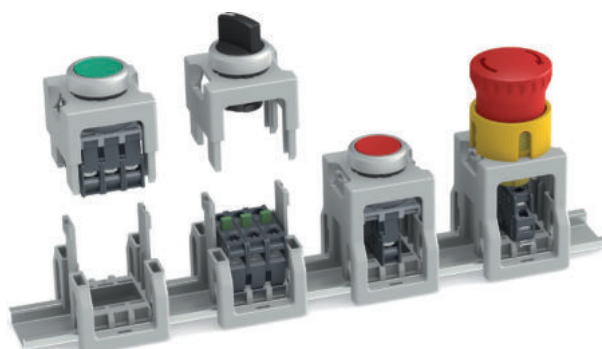



All values in the drawings are in mm

Labels with laser engraving

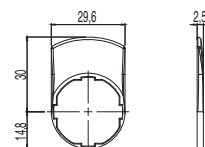

Labels for single EROUND line devices, adjustable by 90° in 90° increments. Available in black, grey, and yellow; the engraving is via laser, directly on the label itself. This avoids having to apply additional labels, and the command description remains permanent and indelible, for the entire lifetime of the label. Labels are customisable with various laser engraving types, according to customer requirements.



| Article | Description | Pieces/Pack |
|--------------|--|-------------|
| VE TF32H9700 | Grey label, without engraving | 10 |
| VE TF12H1700 | Black label, without engraving | 10 |
| VE TF32H5700 | Yellow label, without engraving | 10 |
| VE TF32H91●● | Grey label, with indelible laser engraving | 1 |
| VE TF12H12●● | Black label, with indelible laser engraving | 1 |
| VE TF32H51●● | Yellow label, with indelible laser engraving | 1 |

It does not alter the IP protection degree of the associated device.

Not applicable on E2 •PD●●●●●●, E2 •PT●●●●●●, E2 •PQ●●●●●● double, triple, and quadruple buttons.

For ordering engraved labels:

Replace the dots ●● in the article codes with the engraving code reported on the table at page 165.

Example: Black label with "STOP" engraving. VE TF12H12●● → VE TF12H12GB0

Label holders



Label holders for single device, adjustable by 90° in 90° increments. The switch labels of other manufacturers can be used (for example: 3M article KE-7270-2691-3 or GRAFOPLAST article SITM612X) as long as they have the following dimensions: base 27 +0/-0.4 mm, height 18+0/-0.4 mm, thickness 0.8 ±0.4 mm.

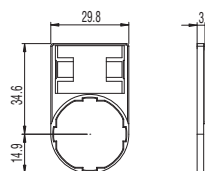

| Article | Description | Pieces/Pack |
|----------------|--|-------------|
| VE PT32A00A0 | Label holder provided with shaped hole, for 18x27 mm label, without label | 10 |
| VE PT32A10A0 | Label holder provided with shaped hole, for 18x27 mm label, and transparent protection label without engraving | 10 |
| VE PT32A09A●●● | Label holder provided with shaped hole, for 18x27 mm label, and glossy aluminium-coloured label with black engraving | 1 |

It does not alter the IP protection degree of the associated device.

Not applicable on E2 •PD●●●●●●, E2 •PT●●●●●●, E2 •PQ●●●●●● double, triple, and quadruple buttons. Not applicable in presence of shaped rings, adapters from Ø 22 to Ø 30 mm, guards or protection caps.

For ordering engraved labels:

Replace the dots ●● in the article codes with the engraving code reported on the table at page 165.

Example: Label holder provided with label, "STOP" engraving. VE PT32A09A●●● → VE PT32A09AGB0

Labels

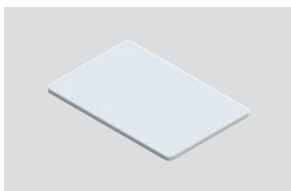

| Article | Description |
|------------|--|
| VE TR3A770 | Protective label for VE PT label holders without engraving. Packs of 100 pcs. |

Rectangular label 18x27 mm, thickness 0.4 mm, transparent anti-glare polycarbonate. Ideal for protecting the label below



| Article | Description |
|--------------|--|
| VE TR4A970 | Label for VE PT label holders without engraving, for cutter or laser engraving. Packs of 100 pcs. |
| VE TR4A91●●● | Label for VE PT label holders with black indelible laser engraving. |

Rectangular label 18x27 mm, thickness 0,8 mm, white aluminium RAL 9006

For ordering engraved labels:

Replace the dots ●● in the article codes with the engraving code reported on the table at page 165.

Example: Label with "STOP" engraving. VE TR4A91●●● → VE TR4A91GB0

All values in the drawings are in mm

Shaped ring

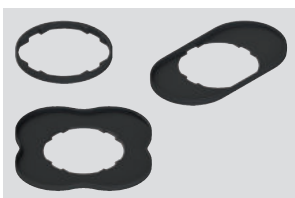

| Article | Description | Pieces/Pack |
|------------|--|-------------|
| VE GP12H1A | Shaped ring for single device | 50 |
| VE GP12L1A | Shaped ring for E2 •PD•••••• - E2 •PT•••••• double and triple button | 50 |
| VE GP12M1A | Shaped ring for quadruple button E2 •PQ•••••• | 10 |

Not applicable in presence of label holders, adapters from Ø 22 to Ø 30 mm, guards or protection caps.
It does not alter the IP protection degree of the associated device.

Protection cap

Packs of **10 pcs.****Technical data:**

Material: silicon suitable for contact with food
 Protection degree: IP67
 Ambient temperature: -40°C ... +80°C
 Ideal for dusty food environments or in presence of water and sand.

| Article | Description |
|----------|--|
| VE CA1A1 | Protective cap for single flush button (panel width from 1 to 5 mm) |
| VE CA1B1 | Protection cap for single projecting button (panel width from 1 to 5 mm) |
| VE CA1C1 | Protection cap for double and triple projecting buttons (panel width from 1 to 6 mm) |
| VE CA1D1 | Protection cap for double flush button (panel width from 1 to 6 mm) |

Not applicable in presence of shaped rings, label holders, adapters from Ø 22 to Ø 30 mm or protection guards.

Connection block

Packs of **10 pcs.**

Connection blocks without electrical contacts and dimensions identical to those of the contact blocks.
 If combined with the VE DL series luminous disc it can be mounted without using terminals or crimping.

| Article | Description |
|-----------|------------------------------------|
| VE BC2PV1 | Panel mounting connection block |
| VE BC2FV1 | Connection block for base mounting |

Diode unit

Packs of **10 pcs.**

Diode blocks of the same size as contact blocks, containing a 3 A 1800 V diode inside.
 To be used in sections of circuits where it is necessary to ensure that the direction of current flow respects the prescribed polarity.

| Article | Description |
|-----------|--|
| VE BD1PV1 | Diode unit, with panel mounting and screw connections |
| VE BD1PM1 | Diode unit, with panel mounting and PUSH-IN spring connections |
| VE BD1FV1 | Diode unit, with base mounting and screw connections |
| VE BD1FM1 | Diode unit, with base mounting and PUSH-IN spring connections |

Closing cap

Packs of **10 pcs.****Technical data:**

Body and ring material: technopolymer
 Protection degree: IP67 and IP69K
 Tightening torque: 2 ... 2.5 Nm

| Article | Description |
|-------------|-------------------------------------|
| E2 1TA1A110 | Black closing cap for Ø 22 mm holes |

Dust protection

Packs of **50 pcs.**

| Article | Description |
|-----------|---|
| VE PR3A70 | Transparent dust protection for E2 series contact blocks. Suitable for all panel mounting contact blocks. |

All values in the drawings are in mm

Windowed protection guard



| Article | Description |
|------------|--|
| VE GP32A5A | Cylindrical yellow protection guard with 4 windows |

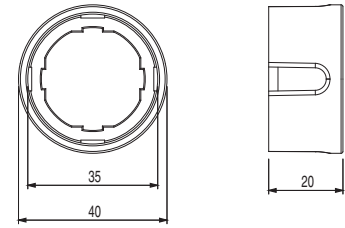

It does not alter the IP protection degree of the associated device.

Not applicable in presence of shaped rings, label holders, adapters from Ø 22 to Ø 30 mm or protection caps.

Cylindrical protection guard



| Article | Description | Colour |
|------------|-------------------------------------|---|
| VE GP32B5A | Cylindrical yellow protection guard |  |
| VE GP32B1A | Cylindrical black protection guard |  |
| VE GP32B4A | Cylindrical green protection guard |  |
| VE GP32B6A | Cylindrical blue protection guard |  |

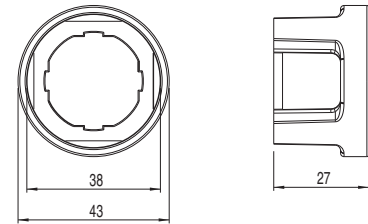

It does not alter the IP protection degree of the associated device.

Not applicable on emergency stop buttons of the E2 •PE••••• series.

Not applicable in presence of shaped rings, label holders, adapters from Ø 22 to Ø 30 mm or protection caps.

Open protection guard

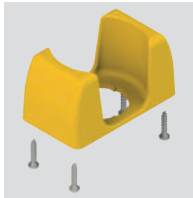

| Article | Description |
|------------|--|
| VE GP32F5A | Rectangular open yellow protection guard complete with 4 screws (for panels of thickness from 1 to 3.5 mm) |

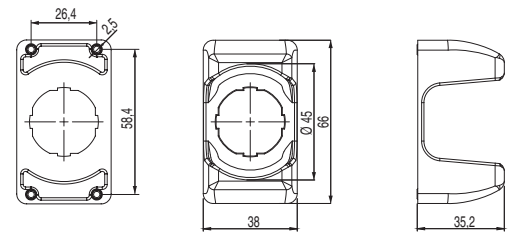

It does not alter the IP protection degree of the associated device.

Not applicable in presence of shaped rings, label holders, adapters from Ø 22 to Ø 30 mm or protection caps.

Lockable guard

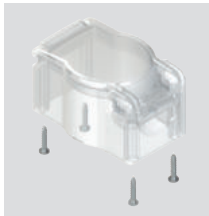

| Article | Description |
|------------|--|
| VE GG3EA7A | Lockable guard complete with 4 screws (for panel thicknesses between 1 and 3.5 mm) |

Ideal for protecting devices which must not be actuated involuntarily.

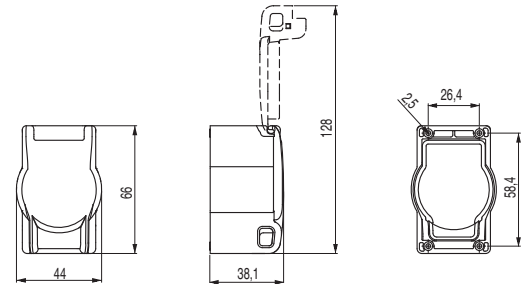

It does not alter the IP protection degree of the associated device.

Not applicable with attached label holder.

Application examples of guards

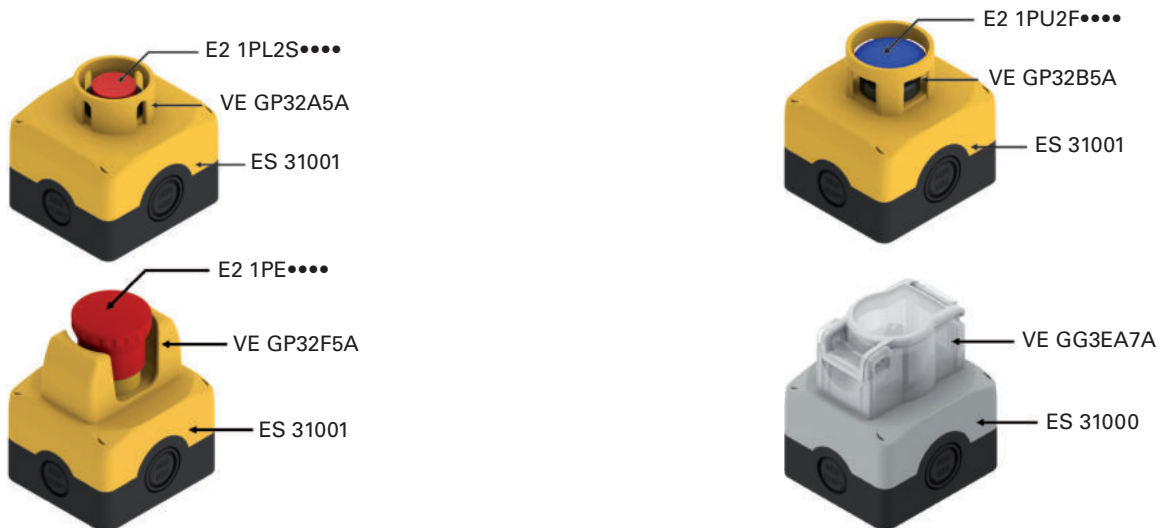













































































All values in the drawings are in mm

List of available engravings

| Code | Symbol | Code | Symbol | Code | Symbol | Code | Symbol | Code | Symbol | Code | Symbol |
|------|--------|------|--------|------|--------|------|--------|------|--------|------|--------|
| L1 | | L42 | | L27 | | L330 | | L187 | | L386 | |
| L287 | | L43 | | L147 | | L455 | | L230 | | L395 | |
| L413 | | L213 | | L148 | | L456 | | L249 | | L411 | |
| L2 | | L254 | | L162 | | L369 | | L376 | | L414 | |
| L3 | | L17 | | L172 | | L426 | | L102 | | L415 | |
| L4 | | L44 | | L220 | | L59 | | L103 | | L418 | |
| L35 | | L45 | | L277 | | L64 | | L139 | | L419 | |
| L36 | | L46 | | L226 | | L62 | | L140 | | L420 | |
| L37 | | L60 | | L142 | | L63 | | L141 | | L80 | |
| L11 | | L191 | | L54 | | L86 | | L157 | | L374 | |
| L12 | | L193 | | L56 | | L88 | | L381 | | L476 | |
| L412 | | L308 | | L57 | | L89 | | L445 | | L472 | |
| L188 | | L61 | | L55 | | L87 | | L278 | | L473 | |
| L14 | | L153 | | L146 | | L76 | | L323 | | L474 | |
| L32 | | L194 | | L293 | | L77 | | L362 | | L475 | |
| L33 | | L309 | | L304 | | L78 | | L380 | | | |
| L34 | | L408 | | L305 | | L190 | | L382 | | | |
| L240 | | L145 | | L470 | | L416 | | L383 | | | |
| L16 | | L336 | | L317 | | L417 | | L384 | | | |
| L41 | | L96 | | L319 | | L189 | | L385 | | | |



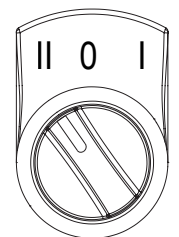

Other engravings on request

| Code | Symbol | Code | Symbol | Code | Symbol | Code | Symbol | Code | Symbol | Code | Symbol |
|------|---|------|---|------|---|------|--|------|---|------|--|
| L7 |  | L25 |  | L84 |  | L174 |  | L316 |  | L441 |  |
| L8 |  | L30 |  | L90 |  | L175 |  | L394 |  | L295 |  |
| L9 |  | L31 |  | L91 |  | L176 |  | L399 |  | | |
| L10 |  | L58 |  | L312 |  | L294 |  | L436 |  | | |
| L18 |  | L75 |  | L311 |  | L313 |  | L437 |  | | |
| L143 |  | L425 |  | L442 |  | L314 |  | L438 |  | | |
| L24 |  | L454 |  | L443 |  | L227 |  | L439 |  | | |
| L310 |  | L83 |  | L170 |  | L228 |  | L440 |  | | |
| L234 |  | L241 |  | L247 |  | L279 |  | L392 |  | L467 |  |
| L235 |  | L242 |  | L248 |  | L280 |  | L393 |  | L468 |  |
| L236 |  | L243 |  | L251 |  | L375 |  | L463 |  | | |
| L237 |  | L244 |  | L252 |  | L389 |  | L464 |  | | |
| L238 |  | L245 |  | L253 |  | L390 |  | L465 |  | | |
| L239 |  | L246 |  | L260 |  | L391 |  | L466 |  | | |
| L19 | 0 | L185 | 1 2 3 | L155 | AUTO 0 MAN. | L359 | START AUTO | L232 | R 0 F | | |
| L20 | 0 | L259 | 1 2 3 4 | L164 | AUTO. MAN. | L360 | STOP AUTO | L307 | FWD 0 REV | | |
| L21 | 0 | L452 | STOP START | L377 | AUTOMATIC 0 1 | L163 | SLOW FAST | L469 | FWD REV | | |
| L22 | 0 | L156 | ↑ ↓ | L342 | MAN OFF AUTO | L404 |   | L144 | BARRIER BY-PASS & RESET 0 1 | | |
| L219 | o - | L262 |  | L266 | AUTO-0-MAIN | L171 | HIGH LOW | L217 | CLOSE OPEN | | |



Example of 3-position selector with VE TF••H•••• label and L21 engraving.

Other engravings on request

| Code | Symbol | Code | Symbol | Code | Symbol | Code | Symbol | Code | Symbol | Code | Symbol |
|------|------------------|------|--------|------|---|------|---|------|---|------|-------------------------|
| L28 | STOP | L67 | 3 | L39 |  | L289 | BOOST | L208 |  | L135 | AVANTI - INDIETRO |
| L50 | STOP | L68 | 4 | L114 | RESET | L292 | MONO / TRI | L117 | POMPA FILTRO 0-1 | L104 | 24V 电源指示 24V Power |
| L48 | STOP | L69 | 5 | L306 | RESET | L327 | ENABLE DISABLE | L118 | FILTER PUMP 0-1 | L105 | 220V 电源指示 220V Power |
| L49 | STOP | L70 | 6 | L130 | 100% | L222 | ACCESS DENIED | L119 | RISCALDAMENTO 0-1 | L106 | 选择开关 Selector |
| L113 | STOP | L71 | 7 | L315 | 24V= | L223 | ACCESS ALLOWED | L120 | HEATING 0-1 | L107 | 启动按钮 START |
| L29 | START | L72 | 8 | L82 | EROUND | L224 | ACCESS REQUEST | L121 | SCATTO TERMICO | L108 | 停止按钮 STOP |
| L53 | START | L73 | 9 | L199 | SPEED | L225 | ACCESS RESET | L122 | CIRCUIT BREAKER | L109 | 电源指示 Power |
| L51 | START | L74 | 0 | L233 | CAUTION | L215 | INIT | L123 | MAN. - AUT. | L110 | 合闸指示 Ready |
| L52 | START | L450 | -1 | L250 | POWER | L216 | C / C | L124 | START CICLO | L111 | 故障指示 Stoppage |
| L218 | START | L451 | -2 | L332 | ALLOW IN | L370 | UNLOCK DOOR | L125 | RADDRIZZATORE 0-1 | | |
| L276 | START STOP | L129 | 3/4 | L334 | SYSTEM START | L371 | REQUEST / RESET ACCESS TO AREA | L126 | STOP CICLO | | |
| L410 | PAUSE (START) | L15 | R | L335 | SYSTEM STOP | L205 | Y+ | L127 | BY-PASS EMERGENZE 0-1 | | |
| L65 | 1 | L40 | R | L333 | CYCLE STOP | L206 |  | L131 | AZIONAMENTO 0-1 | | |
| L66 | 2 | L38 | R | L281 | DEFAULT | L207 |  | L132 | TACITAZIONE SIRENA | | |

Other engravings on request

List of available engravings – TEXTS

| Code | Text | Code | Text | Code | Text | Code | Text |
|------|---------------------|------|----------------|------|-----------------|------|-------------|
| IT0 | ARRESTO | GB0 | STOP | FR0 | ARRÊT | DE0 | HALT |
| IT1 | AVVIO | GB1 | START | FR1 | MARCHE | DE1 | START |
| IT2 | CHIUSO | GB2 | CLOSE | FR2 | FERMÉ | DE2 | ZU |
| IT3 | SU | GB3 | UP | FR3 | MONTÉE | DE3 | AUF |
| IT4 | GIÚ | GB4 | DOWN | FR4 | DESCENTE | DE4 | AB |
| IT5 | SPENTO | GB5 | OFF | FR5 | ARRÊT | DE5 | AUS |
| IT6 | ACCESO | GB6 | ON | FR6 | MARCHE | DE6 | EIN |
| IT7 | IN SERVIZIO | GB7 | RUN | FR7 | EN SERVICE | DE7 | BETRIEB |
| IT8 | ERRORE | GB8 | FAULT | FR8 | PANNE | DE8 | STÖRUNG |
| IT9 | TEST | GB9 | TEST | FR9 | ESSAI | DE9 | PRÜFUNG |
| IT10 | SPENTO ACCESO | GB10 | OFF ON | FR10 | ARRÊT MARCHE | DE10 | AUS EIN |
| IT11 | MAN. AUTO | GB11 | MAN. AUTO | FR11 | MAN. AUTO | DE11 | HAND AUTO |
| IT12 | MAN. 0 AUTO | GB12 | MAN. 0 AUTO | FR12 | MAN. 0 AUTO | DE12 | HAND 0 AUTO |
| IT13 | MARCIA | GB13 | DRIVE | FR13 | MARCHE | DE13 | ANTRIEB |
| IT14 | RIAVVIA | GB14 | RESET | FR14 | REARM. | DE14 | ENTSPERREN |
| IT15 | AVANTI | GB15 | FORWARD | FR15 | AVANT | DE15 | VORWÄRTS |
| IT16 | INDIETRO | GB16 | REVERSE | FR16 | ARRIÈRE | DE16 | RÜCKWÄRTS |
| IT17 | AUMENTA | GB17 | RAISE | FR17 | MONTER | DE17 | HEBEN |
| IT18 | DIMINUISCI | GB18 | LOWER | FR18 | DESCENDRE | DE18 | SENKEN |
| IT19 | SINISTRA | GB19 | LEFT | FR19 | GAUCHE | DE19 | LINKS |
| IT20 | DESTRA | GB20 | RIGHT | FR20 | DROITE | DE20 | RECHTS |
| IT21 | FRENO | GB21 | BRAKE | FR21 | FERMER/OUVRIR | DE21 | BREMSEN |
| IT22 | ALTO | GB22 | HIGH | FR22 | HAUT | DE22 | HOCH |
| IT23 | BASSO | GB23 | LOW | FR23 | BAS | DE23 | NIEDRIG |
| IT24 | VELOCE | GB24 | FAST | FR24 | RAPIDE | DE24 | SCHNELL |
| IT25 | LENTO | GB25 | SLOW | FR25 | LENT | DE25 | LANGSAM |
| IT26 | PIÚ VELOCE | GB26 | FASTER | FR26 | PLUS RAPIDE | DE26 | SCHNELLER |
| IT27 | PIÚ LENTO | GB27 | SLOWER | FR27 | PLUS LENT | DE27 | LANGSAMER |
| IT32 | APRIRE | GB32 | OPEN | FR32 | OUVRIR | DE32 | ÖFFNEN |
| IT63 | CHIAMATA | GB63 | CALL | FR63 | APPEL | DE63 | ANRUF |
| IT64 | OCCUPATO | GB64 | OCCUPIED | FR64 | OCCUPÉ | DE64 | BESETZT |
| IT99 | ARRESTO D'EMERGENZA | GB99 | EMERGENCY STOP | FR99 | ARRÊT D'URGENCE | DE99 | NOT-AUS |

Other engravings on request

General requirements

The product was designed to be installed on switching cabinets or housings containing electrical circuits. All electrical components and devices of the EROUND series that are to be installed inside switching cabinets or enclosures (e.g. E2 CP, E2 CF, E2 LP, E2 LF), are not provided with suitable protections against: water, high quantities of dust, condensation, humidity, steam, corrosive agents, explosive gases, flammable gases or other polluting agents. The protection degree of switching cabinets or enclosures shall ensure the necessary protection to the electrical components of the EROUND series inside them, depending on the application area.

Panel drilling according to EN 60947-5-1

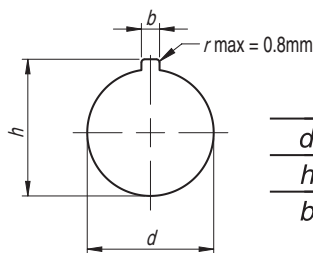

| | Ø 22 | Ø 30 |
|---|-------------------------|-------------------------|
| d | 22,3 ^{+0,4} -0 | 30,5 ^{+0,5} -0 |
| h | 24,1 ^{+0,4} -0 | 33,0 ^{+0,5} -0 |
| b | 3,2 ^{+0,2} -0 | 4,8 ^{+0,2} -0 |

Reference dowel

The mounting reference dowel on the external diameter of all EROUND line devices enables perfect device alignment and mounting on the panel, while avoiding rotations.

In case of use on holes without reference notches, simply remove the dowel with a slight leverage effect using a screwdriver, making sure that the seal gasket does not get damaged.

The removal of the reference dowel, is not advisable for the selectors (series E2 •SE, E2 •SL, E2 •SC) and emergency stop buttons (series E2 •PE) with rotary release, as these devices are subject to rotary-type actuation.

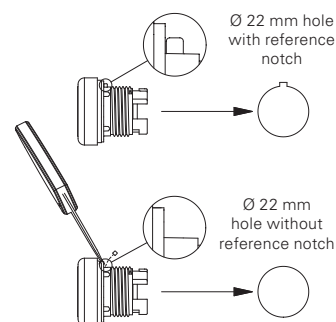

Device connection to mounting adapter

After its installation on the panel using the special ring, the control device can be fixed to the mounting adapter by turning the locking lever. The lever reports the free position (lock open) and locked position (lock closed) indications.

The locking lever rotation can be made smoother by using a flat-head screwdriver.

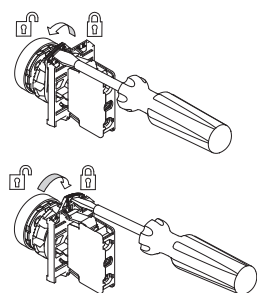

Panel fixing

The control and signalling devices have to be fixed on the rear of the panel with a fixing ring. This has to be tightened with the special fixing key which is supplied as an accessory. The tightening torque for a correct fixing must be between 2 and 2.5 Nm.

Once the fixing ring has been tightened, the mounting adapter and then the contact blocks or LED units can be mounted on the panel.

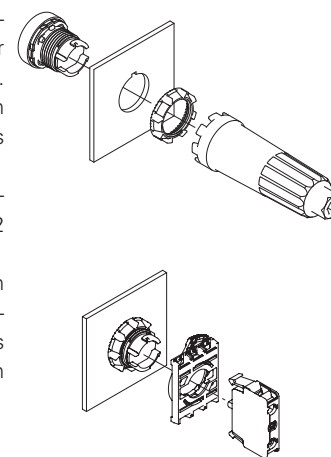

Mounting of contact blocks and LED units

Contact blocks and LED units are provided with two snap-in mounting flaps that ensure a stable fixing between them and the mounting adapter (in the panel mounting version), or between them and the base of the housing (in the base mounting version). The panel contact blocks can be connected to each other, up to three, in observance of the limits specified for each actuator in the respective chapter.

Contact blocks and LED units can be quickly disassembled by using a flat-head screwdriver to leverage on the connection flaps.

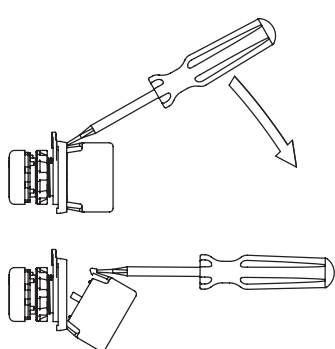

Release of the contact block from the base

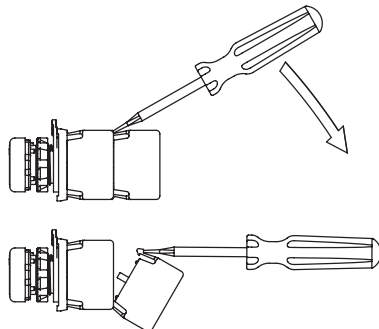

Release of the contact block from another unit

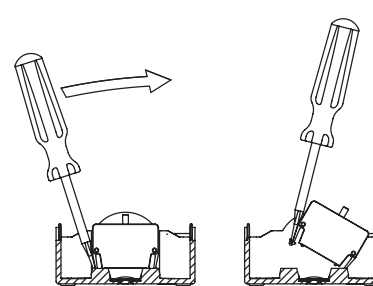

Release of the contact block from the base

Lenses for E2 indicator lights

The E2 indicator lights are provided with interchangeable lenses in different colours. The lenses can be removed and mounted by simply turning them clockwise and anticlockwise respectively, without using tools.

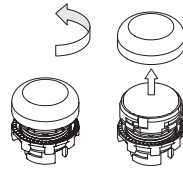

For a correct colour rendering, it is necessary to use the correct combination between colour of the indicator light lens and colour of the LED unit applied to it.

Lenses for buttons and illuminated buttons

The buttons and the illuminated buttons feature replaceable lenses. To remove the lenses, leverage them with a pointed object near the reference notch on the external diameter of the lens itself.

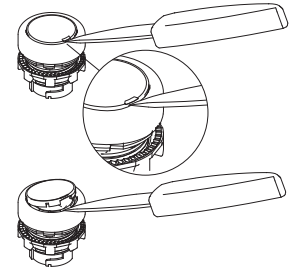

Screw caps insertion / removal

The cover caps supplied for housings of the EROUND series make it possible to close the screws seats, preventing thus the accumulation of dirt and tampering.

These caps are connected to surfaces of the housing. This creates thus a monolithic block showing no visible screws, making it aesthetically pleasing too.

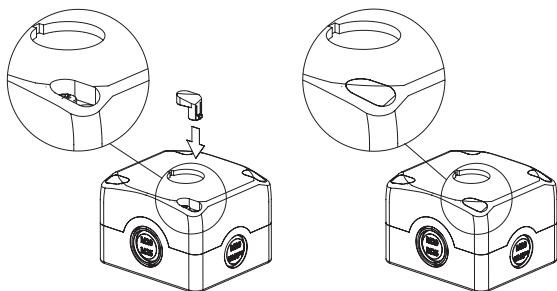

The caps engage to the cover with a simple pressure until the flexible flap snaps in.

For their removal it is necessary to insert the point of a tool (e.g. a small screwdriver) in the special slot on each cap and to leverage on the coupling flap to open it.

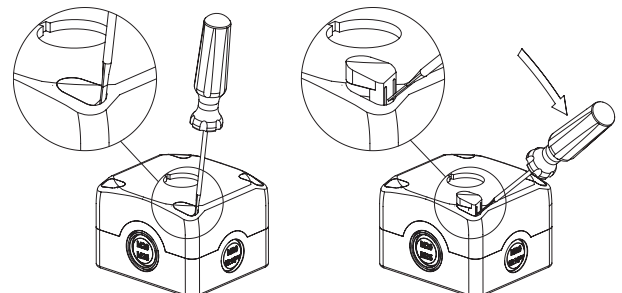

Seal gasket

Thanks to its design, the seal gasket ensures a pre-fixing on the panel.

This allows to mount the ring without having to hold the device in position.

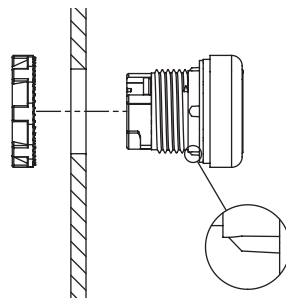

Do not use in following environments:

- Environments where dust and dirt can cover the device and by sedimentation stop its correct working.
- Environment where sudden temperature changes cause condensation.
- Environments where coatings of ice may form on the device.
- Environments where the application causes knocks or vibrations that could damage the device.
- In environments containing explosive or inflammable gases or dusts.
- In environments containing strongly aggressive chemicals, where the products used coming into contact with the device may impair its physical or functional integrity.
- Prior to installation, the installer must ensure that the device is suitable for use under the ambient conditions on site.

Using the devices

- All devices of the EROUND series are hand operated.
- Do not apply excessive force to the device once it has reached the end of its actuation travel.
- Do not exceed the maximum actuation travel.
- Before installation, make sure the device is not damaged in any part.
- Do not disassemble or try to repair the device, in case of defect or fault replace the entire device.
- In case the device is deformed or damaged it must be entirely replaced. Correct operation cannot be guaranteed if the device is deformed or damaged.
- Always attach the following instructions to the manual of the machine in which the device is installed.
- These operating instructions must be kept available for consultation at any time and for the whole period of use of the device.

Limits of use

- Use the devices following the instructions, complying with their operation limits and the standards in force.
- The devices have specific application limits (min. and max. ambient temperature, mechanical endurance, protection degree, etc.) These limits are met by the different devices only if considered individually and not if combined with each other. For further information contact our technical department.
- The utilization implies knowledge of and compliance with following standards: IEC 60204-1, IEC 60947-5-1, ISO 12100.
- Please contact our technical department for information and assistance (phone +39.0424.470.930 / e-mail tech@pizzato.com) in the following cases:
 - cases not mentioned in the present utilization requirements.
 - In nuclear power stations, trains, airplanes, cars, incinerators, medical devices or any application where the safety of two or more persons depend on the correct operation of the devices.

Wiring and installation

- Installation must be carried out by qualified staff only.
- Observe minimum distances between devices (if provided).
- Observe the tightening torques.
- Keep the electrical load below the value specified by the utilization category.
- Disconnect the power before to work on the contacts, also during the wiring.
- Do not paint or varnish the devices.
- Devices can only be installed on perforated surfaces with a thickness of between 1 mm and 6 mm that comply with the IEC 60947-5-1 standard.
- The protection degree and the correct operation are only guaranteed if the product is installed on a level and smooth surface and if the diameter of the holes is compliant with the IEC 60947-5-1 standard.
- After and during the installation do not pull the electrical cables connected to the contact blocks. If excessive tension is applied to the electrical cables, the contact blocks could detach from the actuator.
- During the coupling and uncoupling of the contact blocks from the mounting adapter or from the base, do not deform or put excessive stress on the coupling flaps. A possible deformation of the flaps could cause the detachment of the contact blocks from their mounting adapter.
- No work that can cause high-intensity electrostatic discharges (e.g. stripping or rubbing plastic surfaces or other materials that can be electrostatically charged) may be carried out in the vicinity of devices that are supplied with electrical energy, even if they are switched off or not wired.
- The housings in the EA and ES series are fitted with knock-out holes for the passage of electrical cables. Open these holes using a suitable tool to avoid damaging the housing. Refrain from using housings damaged or cracked as a result of erroneous manoeuvres performed when opening the knock-out holes. After opening the hole, remove any plastic residues and insert a cable gland (or similar device) into the hole with a degree of protection equal or superior to that of the housing.
- After installation and before commissioning of the machine, verify:
 - the correct operation of the device;
 - the correct and full locking of the E2 1BAC●● mounting adapter to the device;
 - the correct coupling of the contact blocks.
- Periodically check for correct device operation.
- Do not deform or modify the device for any reason.
- Before installation, make sure the device is not damaged in any part.
- Refrain from opening, disassembling or attempting to repair the device and replace it immediately if it appears to be damaged.
- Should the installer be unable to fully understand the utilization requirements, the product must not be installed and the necessary assistance may be requested.

Additional requirements for safety applications

Provided that all previous requirements for the devices are fulfilled, for installations with operator protection function additional requirements must be observed.

- The utilization implies knowledge of and compliance with following standards: IEC 60204-1, IEC 60947-5-1, EN ISO 13849-1, EN 62061, EN ISO 12100.
- For emergency stop buttons the safety circuit must be connected to the .1-.2 NC contacts with the actuator in rest position. The auxiliary contacts NO .3-.4 must be used in signalling circuits only.
- The protection fuse (or equivalent device) must be always connected in series with the NC .1-.2 contacts of the safety circuit.
- Periodically verify the correct working of the safety devices; the periodicity of this verification is settled by the machine manufacturer based on the machine danger degree and it does not have to be less than one a year.
- After installation and before commissioning of the machine, verify:
 - the correct operation of the device;
 - the correct and full locking of the E2 1BAC●● mounting adapter;
 - the correct coupling of the contact blocks.
- For the E2 ●PEBZ●●●● emergency stop buttons with key release do not leave the key inserted. A possible sudden activation of the emergency stop button with the key inserted could cause injuries to the operator.
- All the safety devices installed on the machine (e.g. emergency stop button, stop button, automatic/manual mode selector etc.) have a limited endurance. Although still functioning, after 20 years from the date of manufacture the device must be replaced completely. The date of manufacture is placed next to the product code, on the label attached to the packing. In case of particularly adverse weather conditions, the endurance of the device can be drastically reduced over time. Regularly check that the safety devices are working properly and if required, replace them, even prior to the above-mentioned expiry date.
- The device is provided with external marking on its packaging. The marking includes: Producer trademark, product code, batch number and date of manufacture. The batch's first letter refers to the month of manufacture (A = January, B = February, etc.). The second and third letters refer to the year of manufacture (21 = 2021, 22 = 2022, etc.).
- If the device is used for safety applications, inadequate installation or tampering can cause people serious injuries and even death.
- These devices must not be bypassed, removed, turned or disabled in any other way.
- If the machine where the device is installed is used for a purpose other than that specified by the producer, the device may not provide the operator with efficient protection.
- The safety category of the system comprising the safety device also depends on external devices and their connection. Check that the device is capable of performing the safety function envisaged by the risk analysis of the machine, as provided by EN ISO 13849-1.

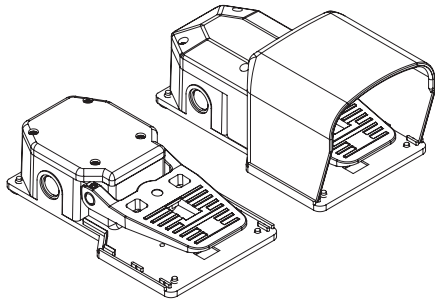

General requirements

- The device is designed to be installed on industrial machineries.
- The installation must be performed only by qualified staff aware of the regulations in force in the country of installation.
- The device must be used exactly as supplied and properly wired.
- It is not allowed to disassemble the product and use only parts of the same, the device is designed to be used in its assembly. It is prohibited to modify the device, even slightly e.g.: replace parts of it, drill it, lubricate it, clean it with gasoline or gas oil or any aggressive chemical agents.
- The protection degree of the device refers to the electrical contacts only.
- Carefully evaluate all the polluting agents present in the application before installing the device, since the IP protection degree refers exclusively to agents such as dust and water according to EN 60529. Thus the device may not be suitable for installation in environments with dust in high quantity, condensation, humidity, steam, corrosive and chemical agents, flammable or explosive gas, flammable or explosive dust or other polluting agents.
- Some devices are provided with a housing with openings for connecting the electrical cables. To guarantee an adequate protection degree of the device, the opening that the wiring passes through must be protected against the penetration of harmful materials by means of an appropriate seal. Proper wiring therefore requires the use of cable glands, connectors or other devices with IP protection degree that is equal to or greater than that of the device.
- Store the products in their original packaging, in a dry place with temperature between -40° C and +70°C
- Failure to comply with these requirements or incorrect use during operation can lead to the damage of the device and the loss of the function performed by the device itself. This will result in termination of the warranty on the item and will release the manufacturer from any liability.

Using the devices

- Before use, check if the national rules provide for further requirements in addition to those given here.
- Avoid contact of the device with corrosive fluids.
- Do not stress the device with bending and torsion.
- Do not apply excessive force to the device once it has reached the end of its actuation travel.
- Do not exceed the maximum actuation travel.
- If specific operating instructions exist for a device (supplied or downloadable from www.pizzato.com), they must always be included with the machine manual and be available for the entire service life of the machine.
- If the pedal has one or more metallic tubes, with a housing equipped with EROUND devices connected to their ends, the utilization requirements indicated on pages 169 to 171 of this catalogue apply.

Wiring and installation

- Installation must be carried out by qualified staff only.
- Use of the device is limited to function as a control switch.
- The product can only be used on flat surfaces.
- Never use the device as support for other machine components (cable ducts, tubes, etc.)
- Keep the electrical load below the value specified by the utilization category.
- Disconnect the power before to work on the contacts, also during the wiring.
- Do not paint or varnish the devices.
- Before installation, make sure the device is not damaged in any part.
- During wiring comply with the following requirements.
 - Comply with the minimum and maximum sections of electrical conductors admitted by terminals.
 - Tighten the electrical terminals with the torque indicated in this catalogue.
 - Do not introduce polluting agents into the device as: talc, lubricants for cable sliding, powder separating agents for multipolar cables, small strands of copper and other pollutants that could affect the proper functioning of the device.
 - Before closing the device cover (if present) verify the correct positioning of the gaskets.
 - Verify that the electrical cables, wire-end sleeves, cable numbering systems and any other parts do not obstruct the cover from closing correctly or if pressed between them do not damage or compress the internal contact block.
 - For devices with integrated cable, the free end of the cable must be properly connected inside a protected housing. The electrical cable must be properly protected from cuts, impacts, abrasion, etc.
- Check that the device application meets the requirements described in paragraph "Do not use in following environments" and "Limits of use" on page 170.
- After installation and before commissioning of the machine, verify:
 - the correct operation of the device and all its parts;
 - the correct wiring and tightening of all screws.
- Perform the following sequence of checks before the machine is commissioned and at least once a year (or after a prolonged shutdown).
 1. The pedal must run freely, and the actuation travel must be linear. No objects or foreign bodies may be present beneath the pedal, which would impede its actuation.
 2. Check that the actuating force is compatible with factory defaults.
 3. Check that the safety lever is functioning correctly: it must not be possible to actuate the pedal, without first having lowered the safety lever (where present).
 4. Check that the locking mechanism of the pedal actuator (where present) is functioning correctly.
 5. Check that the electrical connecting cable and associated cable gland are in good condition, and firmly attached to the device.
 6. Check that, when the pedal is actuated, the machine behaves as expected.
 7. All external parts must be undamaged.
 8. If the device is damaged, replace it completely.
- Should the installer be unable to fully understand the utilization requirements, the product must not be installed and the necessary assistance may be requested.

M12 connectors



- M12 male connectors with cable ▶ 175
- M12 female connectors with cable ▶ 176
- M12 male connectors for panel mounting ▶ 177
- Field wireable M12 female connectors ▶ 178
- Field wireable M12 male connectors ▶ 178

M12 connectors, for series connections



- M12 extension cables ▶ 179
- M12 connectors, Y-shaped ▶ 180
- M12 terminating plugs for series connections ▶ 180

M23 connectors



- M23 male connectors for panel mounting ▶ 181
- M23 female connectors for panel mounting ▶ 182
- M23 female connectors with cable ▶ 183
- Field wireable M23 female connectors ▶ 184
- M23 extension cables with male and female connector ▶ 185

M8 connectors



- M8 female connectors with cable ▶ 186

Cable glands and adapters



Strain relief cable glands
Thread adapters
Protection caps
Threaded nuts
Chock plugs

▶ 187
▶ 187
▶ 188
▶ 188
▶ 188

Tampering protection for M12 connectors

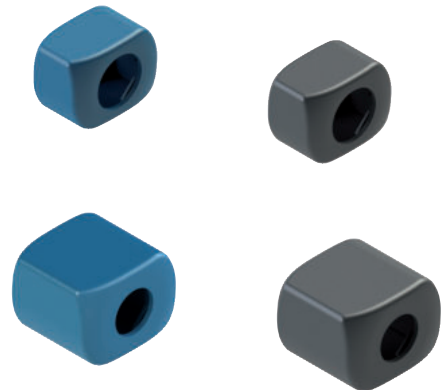

Tampering protection for M12 connectors

▶ 189

LED signalling lights



LED signalling lights

▶ 190

Fixing screws and plates

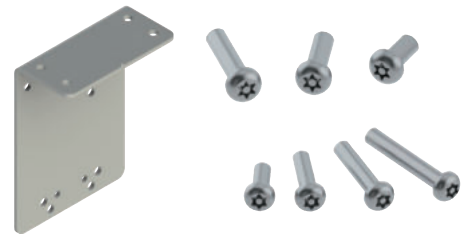

Fixing plates
Torx safety screws
OneWay safety screws
Bits for Torx safety screws

▶ 191
▶ 191
▶ 191
▶ 191

Junction box for series connections



Junction box for series connection of up to 4 devices

▶ 192

M12 male connectors with cable



Features:

- Polyurethane connector body
- Class 6 copper conductors acc. to IEC 60228 - mobile installation
- Gold-plated contacts
- Anti-vibration self-locking ring nut
- High flexibility cable with oil resistant PVC or PUR sheath suitable to be used in drag chains, acc. to IEC 60332-1-2

| | |
|--------------------------------|--|
| Max. operating voltage: | 250 Vac / 300 Vdc (4/5-pole) 30 Vac / 36 Vdc (8/12-pole) |
| Max. operating current: | 4 A (4-5-pole); 2 A (8-pole); 1.5 A (12-pole) |
| Protection degree: | IP67 acc. to EN 60529, IP69K acc. to ISO 20653 (Protect the cables from direct high-pressure and high-temperature jets) |
| Ambient temperature: | -25°C ... +80°C, PVC sheath, fixed installation -15°C ... +80°C, PVC sheath, mobile installation -40°C ... +80°C, PUR sheath, fixed installation -25°C ... +80°C, PUR sheath, mobile installation |
| Wire cross-sections: | 0.34 mm ² (22 AWG) for 4-pole 0.25 mm ² (23 AWG) for 5/8-pole 0.14 mm ² (26 AWG) for 12-pole |
| Minimum bending radius: | > cable diameter x 15 |
| Tightening torque of the ring: | 0.6 ... 0.8 Nm |

Pin assignment

| 5 poles | | 8 poles | |
|---------|--------|---------|--------|
| | | | |
| Pin | Colour | Pin | Colour |
| 1 | Brown | 1 | White |
| 2 | White | 2 | Brown |
| 3 | Blue | 3 | Green |
| 4 | Black | 4 | Yellow |
| 5 | Grey | 5 | Grey |
| | | 6 | Pink |
| | | 7 | Blue |
| | | 8 | Red |

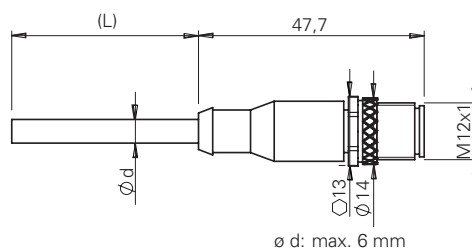

Code structure

Attention! The feasibility of a code number does not mean the effective availability of a product. Please contact our sales office.

article options
VF CF5PD3M-X

No. of poles

| | |
|-----------|----------|
| 4 | 4 poles |
| 5 | 5 poles |
| 8 | 8 poles |
| 12 | 12 poles |

Cable sheath

| | |
|----------|----------------|
| P | PVC (standard) |
| U | PUR |

Connector type

| | |
|----------|---------------------|
| D | straight (standard) |
| G | angled |

Connection type

| | |
|----------|-------|
| M | M12x1 |
|----------|-------|

Fixing ring

| | |
|----------|------------------------------|
| | knurled ring (standard) |
| X | stainless steel hex ring nut |

Cable length (L)

| | |
|-----------|----------------------|
| 1 | 1 metre |
| 2 | 2 metres |
| 3 | 3 metres (standard) |
| 4 | 4 metres |
| 5 | 5 metres (standard) |
| ... | |
| 10 | 10 metres (standard) |

Other lengths on request.

Stock items

| |
|-------------------|
| VF CF5PD3M |
| VF CF8PD3M |

Attention! For items not in stock the minimum order quantity is 100 pcs.

ATTENTION: always disconnect the power supply before removing the connector. The connector is not suitable for separation of electrical loads.

All values in the drawings are in mm

→ The 2D and 3D files are available at www.pizzato.com

M12 female connectors with cable



Features:

- Polyurethane connector body
- Class 6 copper conductors acc. to IEC 60228 - mobile installation
- Gold-plated contacts
- Anti-vibration self-locking ring nut made of nickel-plated brass, available on request in AISI 316L stainless steel hex version
- High flexibility cable with oil resistant PVC or PUR sheath suitable to be used in drag chains, acc. to IEC 60332-1-2

| | |
|--------------------------------|--|
| Max. operating voltage: | 250 Vac / 300 Vdc (4/5-pole) 30 Vac / 36 Vdc (8/12-pole) |
| Max. operating current: | 4 A (4-5-pole); 2 A (8-pole); 1.5 A (12-pole) |
| Protection degree: | IP67 acc. to EN 60529, IP69K acc. to ISO 20653 (Protect the cables from direct high-pressure and high-temperature jets) |
| Ambient temperature: | -25°C ... +80°C, PVC sheath, fixed installation -15°C ... +80°C, PVC sheath, mobile installation -40°C ... +80°C, PUR sheath, fixed installation -25°C ... +80°C, PUR sheath, mobile installation |
| Wire cross-sections: | 0.34 mm ² (22 AWG) for 4-pole 0.25 mm ² (23 AWG) for 5/8-pole 0.14 mm ² (26 AWG) for 12-pole |
| Minimum bending radius: | > cable diameter x 15 |
| Tightening torque of the ring: | 0.6 ... 0.8 Nm |

Pin assignment

| 4 poles | | 5 poles | | 8 poles | | 12 poles | |
|---------|--------|---------|--------|---------|--------|----------|-----------|
| | | | | | | | |
| Pin | Colour | Pin | Colour | Pin | Colour | Pin | Colour |
| 1 | Brown | 1 | Brown | 1 | White | 1 | Brown |
| 2 | White | 2 | White | 2 | Brown | 2 | Blue |
| 3 | Blue | 3 | Blue | 3 | Green | 3 | White |
| 4 | Black | 4 | Black | 4 | Yellow | 4 | Green |
| | | 5 | Grey | 5 | Grey | 5 | Pink |
| | | | | 6 | Pink | 6 | Yellow |
| | | | | 7 | Blue | 7 | Black |
| | | | | 8 | Red | 8 | Grey |
| | | | | | | 9 | Red |
| | | | | | | 10 | Purple |
| | | | | | | 11 | Grey-Pink |
| | | | | | | 12 | Red-Blue |

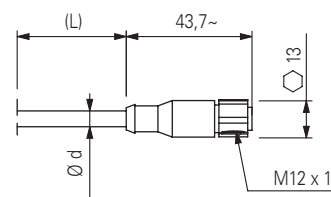
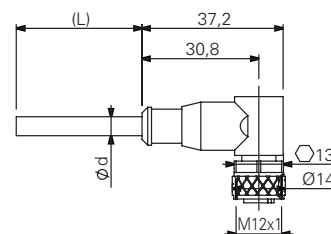
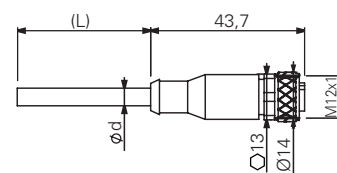

ø d: max. 6 mm

Code structure

Attention! The feasibility of a code number does not mean the effective availability of a product. Please contact our sales office.

| article | | options | |
|------------------------------|--|--------------------------------|------------------------------|
| VF CA4PD3M-X | | | |
| No. of poles | | Connection type | |
| 4 4 poles | | M M12x1 | |
| 5 5 poles | | | |
| 8 8 poles | | Fixing ring | |
| 12 12 poles | | | knurled ring (standard) |
| | | X | stainless steel hex ring nut |
| Cable sheath | | Cable length (L) | |
| P PVC (standard) | | 1 1 metre | |
| U PUR | | 2 2 metres | |
| | | 3 3 metres (standard) | |
| Connector type | | 4 4 metres | |
| D straight (standard) | | 5 5 metres (standard) | |
| G angled | | ... | |
| | | 10 10 metres (standard) | |
| | | Other lengths on request. | |

Stock items

| |
|----------------|
| VF CA4PD3M |
| VF CA4PD5M |
| VF CA4PD10M |
| VF CA5PD3M |
| VF CA5PD5M |
| VF CA5PD10M |
| VF CA8PD3M |
| VF CA8PD5M |
| VF CA8PD10M |
| VF CA8PD20M |
| VF CA12PD3M |
| VF CA12PD5M |
| VF CA12PD10M |
| VF CA12PD20M |
| VF CA12PD30M |
| VF CA8UD5M-X |
| VF CA8UD10M-X |
| VF CA12UD10M-X |

Attention! For items not in stock the minimum order quantity is 100 pcs.

ATTENTION: always disconnect the power supply before removing the connector. The connector is not suitable for separation of electrical loads.

All values in the drawings are in mm

→ The 2D and 3D files are available at www.pizzato.com

M12 male connectors for panel mounting



Features:

- Technopolymer or metal connector body
- Gold-plated contacts
- Wires with crimped ferrules
- Directly installable on the device, these ensure quick replacement, reducing machine down time

| | |
|-------------------------|--|
| Max. operating voltage: | 250 Vac / 300 Vdc (4/5-pole) 30 Vac / 36 Vdc (8/12-pole) |
| Max. operating current: | 4 A (4/5-pole) 2 A (8-pole) 1.5 A (12-pole) |
| Protection degree: | IP67 acc. to EN 60529 IP69K acc. to ISO 20653 |
| Ambient temperature: | -25°C ... +80°C |
| Tightening torque: | 1 ... 1.5 Nm |
| Wire cross-sections: | 0.5 mm ² (20 AWG) for 4/5-pole 0.25 mm ² (23 AWG) for 8-pole 0.14 mm ² (26 AWG) for 12-pole |
| Contact type: | gold-plated |

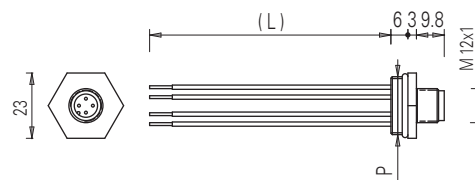

Pin assignment

| 4 poles | | 5 poles | | 8 poles | | 12 poles | |
|---------|--------|---------|--------|---------|--------|----------|-----------|
| | | | | | | | |
| Pin | Colour | Pin | Colour | Pin | Colour | Pin | Colour |
| 1 | Brown | 1 | Brown | 1 | White | 1 | Brown |
| 2 | White | 2 | White | 2 | Brown | 2 | Blue |
| 3 | Blue | 3 | Blue | 3 | Green | 3 | White |
| 4 | Black | 4 | Black | 4 | Yellow | 4 | Green |
| | | 5 | Grey | 5 | Grey | 5 | Pink |
| | | | | 6 | Pink | 6 | Yellow |
| | | | | 7 | Blue | 7 | Black |
| | | | | 8 | Red | 8 | Grey |
| | | | | | | 9 | Red |
| | | | | | | 10 | Purple |
| | | | | | | 11 | Grey-Pink |
| | | | | | | 12 | Red-Blue |

Code structure

Attention! The feasibility of a code number does not mean the effective availability of a product. Please contact our sales office.

| | | | |
|-----------------------|--|-------------------------------|--|
| article | | options | |
| VF CNM5MM-L100 | | | |
| Body material | | Wire length (L) | |
| M metal | | 8.5 cm (standard) | |
| P plastic | | L16 16 cm | |
| | | L100 100 cm | |
| | | L200 200 cm | |
| No. of poles | | Connection type | |
| 4 4 poles | | M M12x1 | |
| 5 5 poles | | Connector thread (P) | |
| 8 8 poles | | M M20 x 1.5 (standard) | |
| 12 12 poles | | P PG 13.5 | |

Stock items

| |
|----------------|
| VF CNP4MM |
| VF CNP4PM |
| VF CNP5MM |
| VF CNP5PM |
| VF CNP8MM |
| VF CNM4MM |
| VF CNM4PM |
| VF CNM5MM |
| VF CNM5PM |
| VF CNM8MM |
| VF CNM8PM |
| VF CNM12MM-L16 |

ATTENTION: always disconnect the power supply before removing the connector. The connector is not suitable for separation of electrical loads.

Note: the 12-pole connector is only available in metal with M20x1.5 thread and 16 cm wires.

Field wireable M12 female connectors



Features:

- Technopolymer connector body
- Gold-plated contacts
- Screw terminals for cable screw fittings

| | |
|--------------------------------|--|
| Max. operating voltage: | 250 Vac/dc (4 and 5-pole) 30 Vac/dc (8-pole) |
| Max. operating current: | 4 A (4 and 5-pole) 2 A (8-pole) |
| Protection degree: | IP67 acc. to EN 60529 |
| Ambient temperature: | -25°C ... +85°C |
| Wire cross-sections: | 0.25 mm ² (23 AWG) ... 0.5 mm ² (20 AWG) |
| Tightening torque of the ring: | 0.6 ... 0.8 Nm |

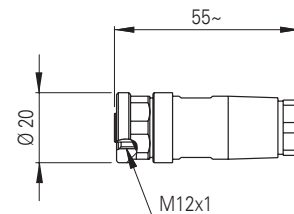

| Article | Description | no. of poles |
|--------------|---|--------------|
| VF CBMP4DM04 | Field wireable M12 female connector, straight, for Ø 4 ... 6.5 mm multipolar cables | 4 |
| VF CBMP5DM04 | Field wireable M12 female connector, straight, for Ø 4 ... 6.5 mm multipolar cables | 5 |
| VF CBMP8DM04 | Field wireable M12 female connector, straight, for Ø 4 ... Ø 7 mm multipolar cables | 8 |

Field wireable M12 male connectors



Features:

- Technopolymer connector body
- Gold-plated contacts
- Screw terminals for cable screw fittings

| | |
|--------------------------------|--|
| Max. operating voltage: | 250 Vac/dc (5-pole) 30 Vac/dc (8-pole) |
| Max. operating current: | 4 A (5-pole) 2 A (8-pole) |
| Protection degree: | IP67 acc. to EN 60529 |
| Ambient temperature: | -25°C ... +85°C |
| Wire cross-sections: | 0.25 mm ² (23 AWG) ... 0.5 mm ² (20 AWG) |
| Tightening torque of the ring: | 0.6 ... 0.8 Nm |

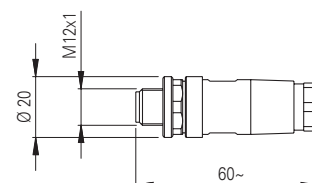

| Article | Description | no. of poles |
|--------------|---|--------------|
| VF CCMP5DM04 | Field wireable M12 male connector, straight, for Ø 4 ... Ø 6.5 mm multipolar cables | 5 |
| VF CCMP8DM04 | Field wireable M12 male connector, straight, for Ø 4 ... Ø 7 mm multipolar cables | 8 |

ATTENTION: always disconnect the power supply before removing the connector. The connector is not suitable for separation of electrical loads.

Series connection with Y-shaped M12 connectors

To facilitate and simplify the series wiring of the safety devices, a variety of accessories designed specifically for this purpose are available. With the help of the proven M12 round connector, safety equipment of Category 4, SIL 3 and PL e with up to 32 elements connected in series is possible. All of which is possible without the risk of connection errors and with a high IP67 protection degree.

The safety circuits consist of a 24 Vdc power supply unit, a number of extensions to the installed devices, Y connectors for branching out from the chain to each individual device and a terminating plug.

In addition to the power supply unit, a suitable safety module is used to assess the state of the safety outputs within the safety chain.

Devices suitable for series connection

The series may consist both of devices that are identical to one another (homogeneous series) or that belong to different series (mixed series).

The following Pizzato Elettrica devices may be connected in series using the Y connectors:

- ST series RFID safety sensors: ST ●●31●M●, ST ●●71●M●.
- NG series RFID safety switches with lock: NG ●●●●●●●-K950, NG ●●●●●●●-K951, NG ●●●●●●●-K952.
- NS series RFID safety switches with lock: NS ●●●●●●Q●.
- HX series safety hinge switches: HX BEE1-●●M.

Electrical connection of the chain

| Pin | Colour | Connection |
|-----|--------|------------------------------|
| 1 | Brown | A1 Supply input +24 Vdc |
| 2 | White | OS1 Safety output |
| 3 | Blue | A2 Supply input 0 V |
| 4 | Black | OS2 Safety output |
| 5 | Grey | I4 Solenoid activation input |

Note: By activating/deactivating input I4, all switches of the NG and NS series in the chain simultaneously block/open all guards. Activation and deactivation of input I4 has no effect on the ST sensors and HX hinges in the chain.

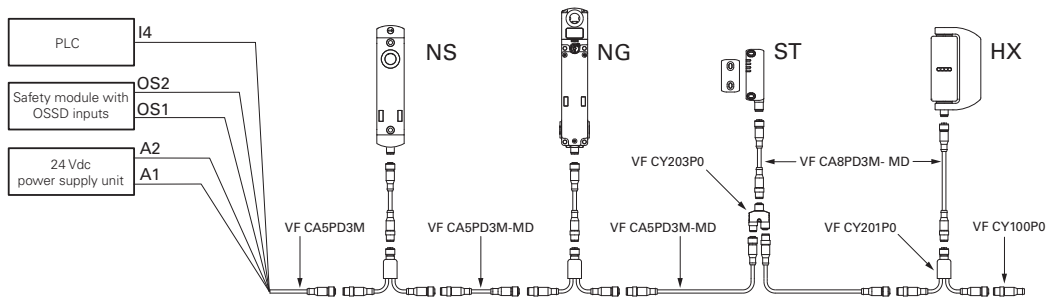

Attention! For proper operation of the devices connected in series via cables or Y connectors, it is necessary to pay particular attention to the voltage drop that occurs in the circuit. Pay particular attention to the currents and cross-sections/lengths of the used cables to ensure that the supply voltage of the components at the end of the series connection remains within the specified limit values during effective operation.

M12 extension cables



Features:

- Polyurethane connector body
- Class 6 copper conductors acc. to IEC 60228
- Gold-plated contacts
- Anti-vibration self-locking ring nut
- High flexibility cable with oil resistant PVC sheath suitable to be used in drag chains, acc. to IEC 60332-1-2

- Max. operating voltage: 250 Vac / 300 Vdc (5-pole)
30 Vac / 36 Vdc (8-pole)
- Max. operating current: 4 A (5-pole), 2 A (8-pole)
- Protection degree: IP67 acc. to EN 60529
IP69K acc. to ISO 2653
(Protect the cables from direct high-pressure and high-temperature jets)
- Ambient temperature: -25°C ... +80°C for fixed installation
-15°C ... +80°C for mobile installation
- Wire cross-sections: 0.5 mm² (20 AWG) (5-pole)
0.25 mm² (23 AWG) (8-pole)
- Minimum bending radius: > cable diameter x 15
- Tightening torque of the ring: 0.6 ... 0.8 Nm

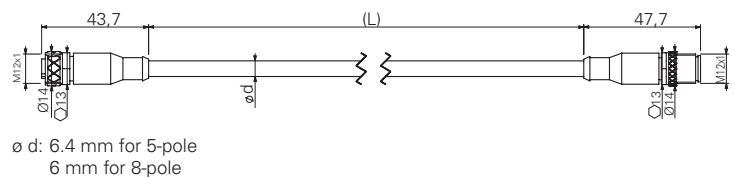

Code structure

VF CA5PD3M-MD

| | |
|-----------------------|---------------------------|
| No. of poles | Connection type |
| 5 5 poles | M M12x1 |
| 8 8 poles | |
| Cable sheath | Cable length (L) |
| P PVC | 3 3 metres (standard) |
| | 5 5 metres (standard) |
| | 10 10 metres (standard) |
| | Other lengths on request. |
| Connector type | |
| D straight | |

Pin assignment

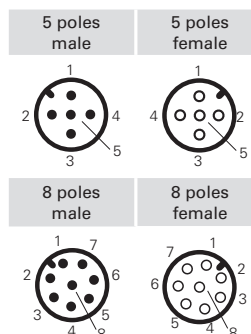

Stock items

- VF CA5PD3M-MD
- VF CA5PD5M-MD
- VF CA5PD10M-MD
- VF CA8PD3M-MD
- VF CA8PD5M-MD
- VF CA8PD10M-MD

Attention! For items not in stock the minimum order quantity is 100 pcs.

ATTENTION: always disconnect the power supply before removing the connector. The connector is not suitable for separation of electrical loads.

All values in the drawings are in mm

→ The 2D and 3D files are available at www.pizzato.com

M12 connectors, Y-shaped, for series connections



| Article | Description |
|------------|--|
| VF CY201P0 | M12 connector, Y-shaped, for series connections with 150 mm cable length |

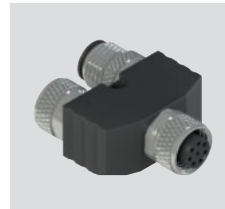

| Article | Description |
|------------|---|
| VF CY203P0 | M12 connector, Y-shaped, for series connections without cable |

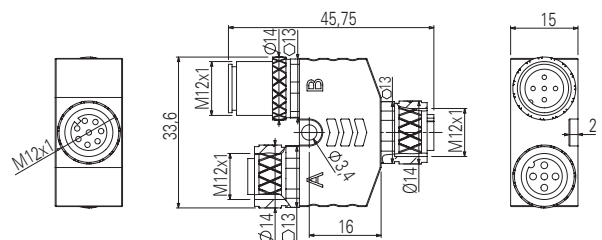
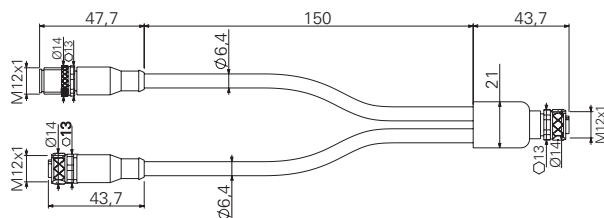

Features:

- Polyurethane connector body
- Gold-plated contacts
- Anti-vibration self-locking ring nut
- Class 6 copper conductors acc. to IEC 60228
- High flexibility cable with oil resistant PVC sheath suitable to be used in drag chains, acc. to IEC 60332-1-2

| | |
|--------------------------------|---|
| Max. operating voltage: | 30 Vac / 36 Vdc |
| Max. operating current: | 4 A (5-pole) 2 A (8-pole) |
| Protection degree: | IP67 acc. to EN 60529 |
| Ambient temperature: | -25°C ... +80°C for fixed installation -15°C ... +80°C for mobile installation |
| Wire cross-sections: | 0.5 mm ² (20 AWG) |
| Minimum bending radius: | > cable diameter x 15 |
| Tightening torque of the ring: | 0.6 ... 0.8 Nm |

Internal block diagram, Y-shaped connector

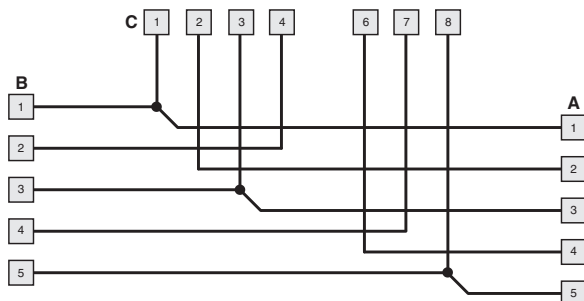

Pin assignment

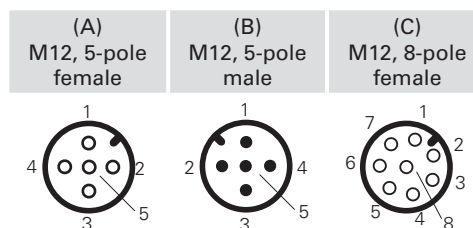

IMPORTANT: When used in safety applications, the Y connectors must be installed in a location that is not directly accessible, so as to avoid shocks or tampering.

M12 terminating plugs for series connections



Features:

- Polyurethane connector body
- Gold-plated contacts
- Anti-vibration self-locking ring nut

| | |
|--------------------------------|-----------------------|
| Max. operating voltage: | 250 Vac / 300 Vdc |
| Max. operating current: | 4 A |
| Protection degree: | IP67 acc. to EN 60529 |
| Tightening torque of the ring: | 0.6 ... 0.8 Nm |

Internal block diagram of the terminating plug

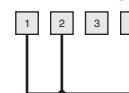

Pin assignment

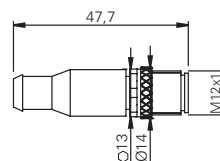
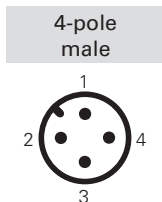

| Article | Description |
|------------|--|
| VF CY100P0 | M12 terminating plugs for series connections, 4-pole |

ATTENTION: always disconnect the power supply before removing the connector. The connector is not suitable for separation of electrical loads.

All values in the drawings are in mm

→ The 2D and 3D files are available at www.pizzato.com

M23 male connectors for panel mounting

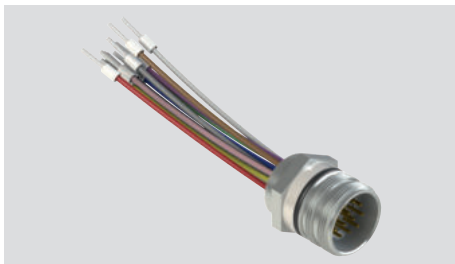

Features:

- Threaded connection M20 for installation on switches with M20 cable entry (for example: FG series and NG series)
- Nickel-plated metal connector body
- Gold-plated contacts
- 12-pole or 19-pole versions
- Wires with pre-insulated ferrules
- Directly installable on the device, these ensure quick replacement, reducing machine down time

| | |
|-------------------------|--|
| Max. operating voltage: | 250 Vac (12-pole) 100 Vac (19-pole) |
| Max. operating current: | 3 A |
| Protection degree: | IP67 acc. to EN 60529 IP69K acc. to ISO 20653 |
| Ambient temperature: | -25°C ... +80°C |
| Tightening torque: | 1 ... 1.5 Nm |
| Wire cross-section: | 0.34 mm ² (22 AWG) |
| Contact type: | gold-plated |

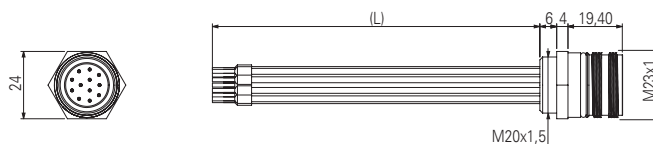

Pin assignment

12 poles

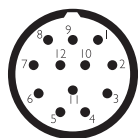

19-pole

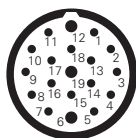

| Pin | Colour | Pin | Colour | Pin | Colour |
|-----|-----------|-----|-----------|-----|--------------|
| 1 | White | 1 | White | 13 | White-Green |
| 2 | Brown | 2 | Brown | 14 | Brown-Green |
| 3 | Green | 3 | Green | 15 | White-Yellow |
| 4 | Yellow | 4 | Yellow | 16 | Yellow-Brown |
| 5 | Grey | 5 | Grey | 17 | White-Grey |
| 6 | Pink | 6 | Pink | 18 | Grey-Brown |
| 7 | Blue | 7 | Blue | 19 | White-Pink |
| 8 | Red | 8 | Red | | |
| 9 | Black | 9 | Black | | |
| 10 | Purple | 10 | Purple | | |
| 11 | Grey-Pink | 11 | Grey-Pink | | |
| 12 | Red-Blue | 12 | Red-Blue | | |

Code structure

Attention! The feasibility of a code number does not mean the effective availability of a product. Please contact our sales office.

VF CNM12MT-L10

Body material

M metal

Wire length (L)

L10 10 cm

L16 16 cm

No. of poles

12 12 poles

19 19-pole

Note:

For applications with NG series switches, use connectors with L10 wire length.
For applications with FG series switches, use connectors with L16 wire length.

ATTENTION: always disconnect the power supply before removing the connector. The connector is not suitable for separation of electrical loads.

All values in the drawings are in mm

→ The 2D and 3D files are available at www.pizzato.com

M23 female connectors for panel mounting

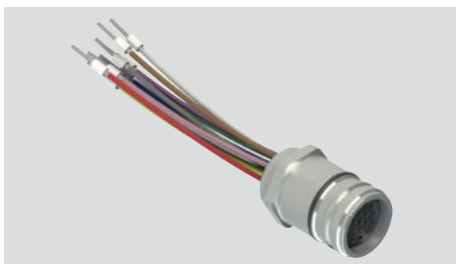

Features:

- Threaded connection M20
- Nickel-plated metal connector body
- Gold-plated contacts
- 12-pole or 19-pole versions
- Wires with pre-insulated ferrules
- Directly installable on the device, these ensure quick replacement, reducing machine down time

| | |
|-------------------------|--|
| Max. operating voltage: | 250 Vac (12-pole) 100 Vac (19-pole) |
| Max. operating current: | 3 A |
| Protection degree: | IP67 acc. to EN 60529 IP69K acc. to ISO 20653 |
| Ambient temperature: | -25°C ... +80°C |
| Tightening torque: | 1 ... 1.5 Nm |
| Wire cross-section: | 0.34 mm ² (22 AWG) |
| Contact type: | gold-plated |

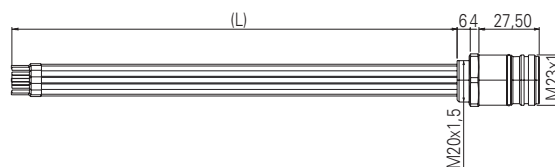

Pin assignment

12 poles

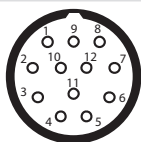

19-pole

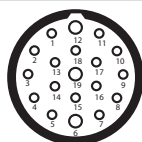

| Pin | Colour | Pin | Colour | Pin | Colour |
|-----|-----------|-----|-----------|-----|--------------|
| 1 | White | 1 | White | 13 | White-Green |
| 2 | Brown | 2 | Brown | 14 | Brown-Green |
| 3 | Green | 3 | Green | 15 | White-Yellow |
| 4 | Yellow | 4 | Yellow | 16 | Yellow-Brown |
| 5 | Grey | 5 | Grey | 17 | White-Grey |
| 6 | Pink | 6 | Pink | 18 | Grey-Brown |
| 7 | Blue | 7 | Blue | 19 | White-Pink |
| 8 | Red | 8 | Red | | |
| 9 | Black | 9 | Black | | |
| 10 | Purple | 10 | Purple | | |
| 11 | Grey-Pink | 11 | Grey-Pink | | |
| 12 | Red-Blue | 12 | Red-Blue | | |

Code structure

Attention! The feasibility of a code number does not mean the effective availability of a product. Please contact our sales office.

VF CPM12MT-L10

| | |
|--------------------|------------------|
| Body material | Wire length (L) |
| M metal | L10 10 cm |
| No. of poles | L20 20 cm |
| 12 12 poles | |
| 19 19-pole | |

ATTENTION: always disconnect the power supply before removing the connector. The connector is not suitable for separation of electrical loads.

All values in the drawings are in mm

→ The 2D and 3D files are available at www.pizzato.com

M23 female connectors with cable



Features:

- Polyurethane connector body
- Class 5 tin-plated copper conductors acc. to IEC 60228 (12-pole)
- Class 5 tin-plated copper conductors acc. to IEC 60228 (19-pole)
- Gold-plated contacts
- Anti-vibration self-locking ring nut
- Cable with PVC sheath acc. to IEC 60332-1-2 (flame retardant)

| | |
|--|--|
| Max. operating voltage: | 160 Vac (12-pole) 63 Vac (19-pole) |
| Maximum operating current with 12 poles: | 5 A x 0.5 mm ² (20 AWG), the currents are per conductor |
| Maximum operating current with 19 poles: | 8 A x 0.75 mm ² + 4 A x 0.34 mm ² (22 AWG), the currents are per conductor |
| Protection degree: | IP67 acc. to EN 60529 IP69K acc. to ISO 20653 (Protect the cables from direct high-pressure and high-temperature jets) |
| Ambient temperature: | -5°C ... +70°C |
| Wire cross-section: | 12x0,5 mm ² (12-pole) 17x0.34 mm ² + 2x0.75 mm ² (19-pole) |
| Minimum bending radius: | > cable diameter x 15 |
| Tightening torque of the ring: | 1 ... 1.5 Nm |

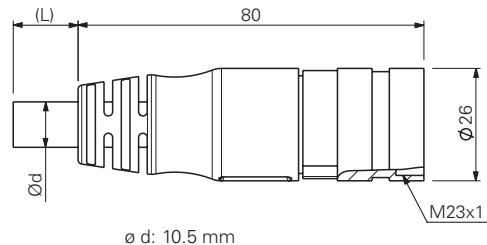

Pin assignment

12 poles

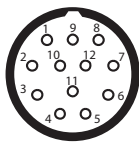

19-pole

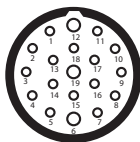

| Pin | Colour | Pin | Colour | Pin | Colour |
|-----|-----------|-----|-----------|-----|--------------|
| 1 | White | 1 | White | 13 | White-Green |
| 2 | Brown | 2 | Brown | 14 | Brown-Green |
| 3 | Green | 3 | Green | 15 | White-Yellow |
| 4 | Yellow | 4 | Yellow | 16 | Yellow-Brown |
| 5 | Grey | 5 | Grey | 17 | White-Grey |
| 6 | Pink | 6 | Pink | 18 | Grey-Brown |
| 7 | Blue | 7 | Blue | 19 | White-Pink |
| 8 | Red | 8 | Red | | |
| 9 | Black | 9 | Black | | |
| 10 | Purple | 10 | Purple | | |
| 11 | Grey-Pink | 11 | Grey-Pink | | |
| 12 | Red-Blue | 12 | Red-Blue | | |

Code structure

Attention! The feasibility of a code number does not mean the effective availability of a product. Please contact our sales office.

VF CA12PD20S

| | |
|--------------------|---------------------|
| No. of poles | Connection type |
| 12 12 poles | S M23x1 |
| 19 19-pole | |
| Cable sheath | Cable length (L) |
| P PVC | 5 5 metres |
| | 10 10 metres |
| Connector type | 20 20 metres |
| D straight | 30 30 metres |

Other lengths on request.

Stock items

VF CA12PD10S
VF CA12PD20S
VF CA12PD30S
VF CA19PD5S
VF CA19PD10S
VF CA19PD20S
VF CA19PD30S

Attention! For items not in stock the minimum order quantity is 50 pcs.

ATTENTION: always disconnect the power supply before removing the connector. The connector is not suitable for separation of electrical loads.

All values in the drawings are in mm

→ The 2D and 3D files are available at www.pizzato.com

Field wireable M23 female connectors



Features:

- Nickel-plated metal connector body
- Gold-plated contacts
- 12-pole or 19-pole versions

| | |
|--------------------------------|--|
| Max. operating voltage: | 250 Vac (12-pole) 100 Vac (19-pole) |
| Max. operating current: | 8 A |
| Protection degree: | IP67 acc. to EN 60529 IP69K acc. to ISO 20653 |
| Ambient temperature: | -40°C ... +125°C |
| Tightening torque of the ring: | 1 ... 1.5 Nm |
| Pollution degree: | 3 |

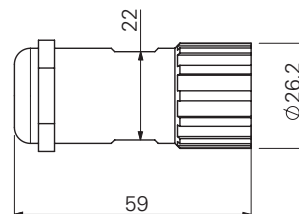

Pin configuration

12 poles

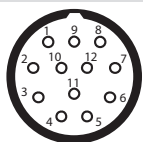

clockwise numbering

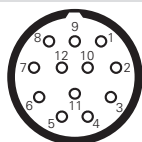

counterclockwise numbering

19-pole

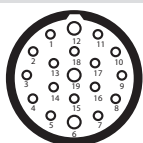

clockwise numbering



| Article | Description |
|-----------|--------------|
| VF AC2205 | Mounting key |

Note: Article required for opening and wiring of connector.

Code structure

Attention! The feasibility of a code number does not mean the effective availability of a product. Please contact our sales office.

VF CBSM12TC07

Connection type

S M23x1

Body material

M metal

No. of poles

12 12 poles

19 19-pole

Connector type

T clockwise numbering (standard)

D counterclockwise numbering

Cable diameter

07 Ø 7 ... 12 mm

Pin connection type

C crimp connection (standard) 0.34 ... 1 mm²

S solder connection 0.34 ... 1 mm²

Note: Use appropriate crimp pliers for crimp connections (e.g., Knipex, article number 97 52 63).

Stock items

VF CBSM12TC07

VF CBSM19TC07

VF CBSM12TS07

ATTENTION: always disconnect the power supply before removing the connector. The connector is not suitable for separation of electrical loads.

All values in the drawings are in mm

→ The 2D and 3D files are available at www.pizzato.com

M23 extension cables with male and female connector



Features:

- Polyurethane connector body
- Class 5 tin-plated copper conductors acc. to IEC 60228
- Gold-plated contacts
- Anti-vibration self-locking ring nut
- Cable with PVC sheath acc. to IEC 60332-1-2 (flame retardant)

| | |
|--|--|
| Max. operating voltage: | 63 Vac |
| Maximum operating current with 19 poles: | 8 A x 0.75 mm ² + 4 A x 0.34 mm ² (22 AWG), the currents are per conductor |
| Protection degree: | IP67 acc. to EN 60529 IP69K acc. to ISO 20653 (Protect the cables from direct high-pressure and high-temperature jets) |
| Ambient temperature: | -5°C ... +70°C |
| Wire cross-section: | 17x0.34 mm ² + 2x0.75 mm ² |
| Minimum bending radius: | > cable diameter x 15 |
| Tightening torque of the ring: | 1 ... 1.5 Nm |

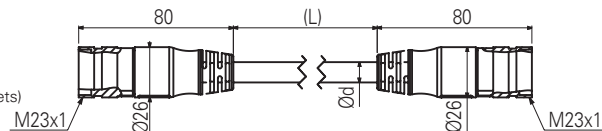

Pin assignment

19-pole male

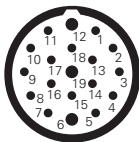

19-pole female

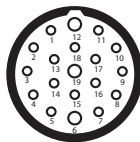

Code structure

Attention! The feasibility of a code number does not mean the effective availability of a product. Please contact our sales office.

VF CA19PD5S-SD

| | | | | | |
|----------------|----|----------|------------------|-----------|----------|
| No. of poles | 19 | 19-pole | Connection type | S | M23x1 |
| Cable sheath | P | PVC | Cable length (L) | 5 | 5 metres |
| Connector type | D | straight | 10 | 10 metres | |
| | | | 20 | 20 metres | |

Other lengths on request.

ATTENTION: always disconnect the power supply before removing the connector. The connector is not suitable for separation of electrical loads.

All values in the drawings are in mm

→ The 2D and 3D files are available at www.pizzato.com

M8 female connectors with cable



Features:

- Polyurethane connector body
- Class 6 copper conductors acc. to IEC 60228
- Gold-plated contacts
- Anti-vibration self-locking ring nut
- High flexibility cable with oil resistant PVC or PUR sheath suitable to be used in drag chains, acc. to IEC 60332-1-2

| | |
|--------------------------------|--|
| Max. operating voltage: | 60 Vac / 75 Vdc |
| Max. operating current: | 4 A |
| Protection degree: | IP67 acc. to EN 60529 IP69K acc. to ISO 20653 (Protect the cables from direct high-pressure and high-temperature jets) |
| Ambient temperature: | -25°C ... +80°C for fixed installation -15°C ... +80°C for mobile installation |
| Wire cross-sections: | 0.25 mm ² (23 AWG) |
| Minimum bending radius: | > cable diameter x 15 |
| Tightening torque of the ring: | 0.3 ... 0.5 Nm |

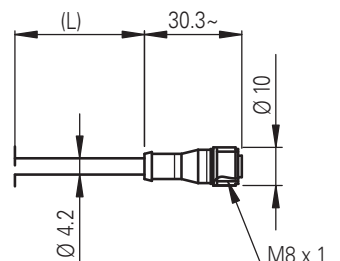

Pin assignment

4 poles

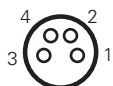

| Pin | Colour |
|-----|--------|
| 1 | Brown |
| 2 | White |
| 3 | Blue |
| 4 | Black |

Code structure

Attention! The feasibility of a code number does not mean the effective availability of a product. Please contact our sales office.

VF CA4PD3K

| | | | |
|----------------|---|---------------------------|--|
| No. of poles | 4 4 poles | Connection type | K M8x1 |
| Cable sheath | P PVC (standard) U PUR | Cable length (L) | 1 1 metre 2 2 metres 3 3 metres (standard) 4 4 metres 5 5 metres (standard) ... 10 10 metres |
| Connector type | D straight | Other lengths on request. | |

Stock items

VF CA4PD3K
VF CA4PD5K

Attention!

For items not in stock the minimum order quantity is 100 pcs.

ATTENTION: always disconnect the power supply before removing the connector. The connector is not suitable for separation of electrical loads.

All values in the drawings are in mm

→ The 2D and 3D files are available at www.pizzato.com

Strain relief cable glands

Packs of **10 pcs.**

This particular design ensures high resistance to traction of the cable glands. All cable glands are also suitable for a wide range of cable diameters.

Suitable for circular cross-section cables only.

Features:

Body and ring material: technopolymer without halogen

Protection degree: IP67 acc. to EN 60529

Tightening torque: 3 ... 4 Nm (PG 13.5/M20)

2 ... 2.5 Nm (PG 11/M16)

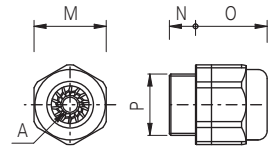

| | Article | Description | A | ⬡M | N | O | P |
|----------------|-------------|--|---|----|-----|----|---------|
| Metric threads | VF PAM25C7N | M25x1.5 cable gland for one cable Ø 10 ... 17 mm | ⊙ | 33 | 10 | 31 | M25x1.5 |
| | VF PAM20C6N | M20x1.5 cable gland for one cable Ø 6 ... 12 mm | ⊙ | 24 | 9 | 24 | M20x1.5 |
| | VF PAM20C5N | M20x1.5 cable gland for one cable from Ø 5 ... 10 mm | ⊙ | 24 | 9 | 24 | M20x1.5 |
| | VF PAM20C3N | M20x1.5 cable gland for one cable Ø 3 ... 7 mm | ⊙ | 24 | 9 | 24 | M20x1.5 |
| | VF PAM16C5N | M16x1.5 cable gland for one cable Ø 5 ... 10 mm | ⊙ | 22 | 7.5 | 23 | M16x1.5 |
| | VF PAM16C4N | M16x1.5 cable gland for one cable Ø 4 ... 8 mm | ⊙ | 22 | 7.5 | 23 | M16x1.5 |
| | VF PAM16C3N | M16x1.5 cable gland for one cable Ø 3 ... 7 mm | ⊙ | 22 | 7.5 | 23 | M16x1.5 |
| | VF PAM20CBN | M20x1.5 multi-hole cable gland for 2 cables Ø 3 ... 5 mm | ⊙ | 24 | 9 | 23 | M20x1.5 |
| | VF PAM20CDN | M20x1.5 multi-hole cable gland for 3 cables Ø 1 ... 4 mm | ⊙ | 24 | 9 | 23 | M20x1.5 |
| | VF PAM20CEN | M20x1.5 multi-hole cable gland for 3 cables Ø 3 ... 5 mm | ⊙ | 24 | 9 | 23 | M20x1.5 |
| | VF PAM20CFN | M20x1.5 multi-hole cable gland for 4 cables Ø 1 ... 4 mm | ⊙ | 22 | 9 | 23 | M20x1.5 |
| PG threads | VF PAP13C6N | PG 13.5 cable gland for one cable from Ø 6 ... 12 mm | ⊙ | 24 | 9 | 24 | PG 13.5 |
| | VF PAP13C5N | PG 13.5 cable gland for one cable from Ø 5 ... 10 mm | ⊙ | 24 | 9 | 24 | PG 13.5 |
| | VF PAP13C3N | PG 13.5 cable gland for one cable from Ø 3 ... 7 mm | ⊙ | 24 | 9 | 24 | PG 13.5 |
| | VF PAP11C5N | PG 11 cable gland for one cable from Ø 5 ... 10 mm | ⊙ | 22 | 7.5 | 23 | PG 11 |
| | VF PAP11C4N | PG 11 cable gland for one cable from Ø 4 ... 8 mm | ⊙ | 22 | 7.5 | 23 | PG 11 |
| | VF PAP11C3N | PG 11 cable gland for one cable from Ø 3 ... 7 mm | ⊙ | 22 | 7.5 | 23 | PG 11 |

Thread adapters

Packs of **100 pcs.**

Thread adapters make it possible to fulfil requests for switches with a different thread to those generally found in stock. This means it is possible to offer customers a single product type with various threaded connections, while only having to stock the product itself and many kinds of adapters.

Features:

Body material: glass fibre reinforced technopolymer

Tightening torque: 3 ... 4 Nm

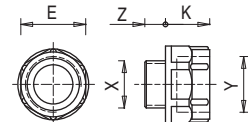

| Article | Description | X | Y | Z | K | ⬡E |
|------------------|---------------------------------|---------|---------|---|----|----|
| VF ADPG13-PG11 | Adapter from PG 13.5 to PG 11 | PG 13.5 | PG 11 | 9 | 12 | 22 |
| VF ADPG13-M20 | Adapter from PG 13.5 to M20x1.5 | PG 13.5 | M20x1.5 | 9 | 14 | 24 |
| VF ADPG13-1/2NPT | Adapter from PG 13.5 to 1/2 NPT | PG 13.5 | 1/2 NPT | 9 | 14 | 24 |
| VF ADPG11-1/2NPT | Adapter from PG 11 to 1/2 NPT | PG 11 | 1/2 NPT | 7 | 14 | 24 |
| VF ADPG11-PG13 | Adapter from PG 11 to PG 13.5 | PG 11 | PG 13.5 | 7 | 14 | 24 |
| VF ADM20-1/2NPT | Adapter from M20x1.5 to 1/2 NPT | M20x1.5 | 1/2 NPT | 9 | 14 | 24 |

Protection caps

Packs of **10 pcs.****Features:**

Body material: technopolymer, self-extinguishing
 Protection degree: IP67 acc. to EN 60529
 IP69K acc. to ISO 20653
 Tightening torque: 1.2 ... 1.6 Nm
 Cross-recessed screw: PH3

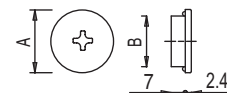

| Article | Description | A | B |
|------------|------------------------|----|---------|
| VF PTM20 | Protection cap M20x1.5 | 24 | M20x1.5 |
| VF PTG13.5 | Protection cap PG13.5 | 24 | PG 13.5 |

Threaded nuts

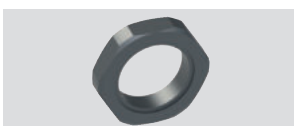
Packs of **10 pcs.****Features:**

Tightening torque: 1.2 ... 2 Nm

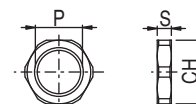

| | Article | Description | S | CH | P |
|---------|-----------|---|---|----|---------|
| Plastic | VF DFPM25 | M25x1.5 threaded technopolymer nut | 6 | 32 | M25x1.5 |
| | VF DFPM20 | M20x1.5 threaded technopolymer nut | 6 | 27 | M20x1.5 |
| | VF DFPM16 | M16x1.5 threaded technopolymer nut | 5 | 22 | M16x1.5 |
| | VF DFPP13 | PG13.5 threaded technopolymer nut | 6 | 27 | PG 13.5 |
| Metal | VF DFMM20 | M20x1.5 threaded nut in nickel-plated brass | 3 | 23 | M20x1.5 |

Chock plugs

Packs of **100 pcs.****Features:**

Body material: technopolymer
 Protection degree: IP54 acc. to EN 60529
 Tightening torque: 0.8 ... 1 Nm

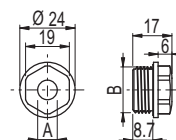

Note: Use a socket wrench for tightening.

| Article | Description | A | B |
|-------------|---|-----|---------|
| VF PFM20C8N | Chock plug for one cable Ø 8 ... 12 mm, threaded, M20x1.5 | 7.5 | M20x1.5 |
| VF PFM20C4N | Chock plug for one cable Ø 4 ... 8 mm, threaded, M20x1.5 | 3.5 | M20x1.5 |

Tampering protection for M12 connectors

Packs of 10 pcs.

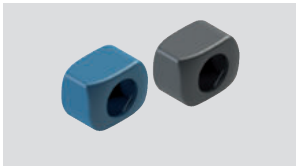

Features:

These tampering protections are composed of two identical snap-on shells. They are applied to the device connectors, thereby making them inaccessible. The shells can only be removed by breaking them. Thus, any attempt to tamper with them will be immediately evident.

The protection can be installed quickly and easily by pressing the two shells lightly into place.

The protections are suitable for all devices with an M12 connector (e.g. NS, ST, SR series) but they can also be used for junctions between cables with male - female connectors.

A version made of detectable plastic is available for the food industry, and it can easily be detected during the process using common optical vision technologies, X-rays or metal detectors.

Installation:

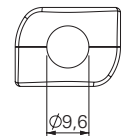
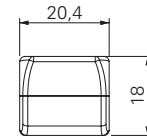
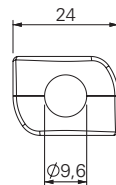
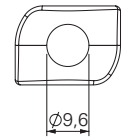
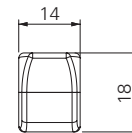
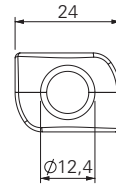
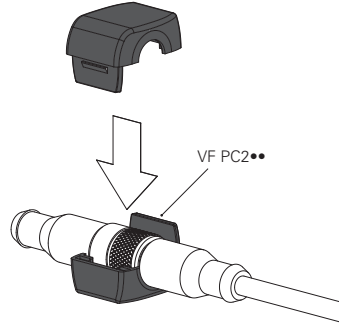
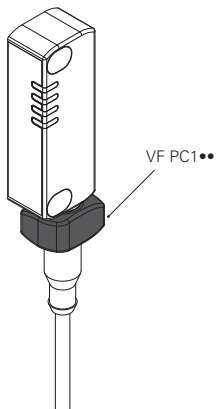

| Article | Description | Colour / material |
|----------|---|---------------------------------|
| VF PC1A9 | Tamper-proof protection for device-side connector | ● Grey technopolymer |
| VF PC2A9 | Tamper-proof protection for male - female connector | ● Grey technopolymer |
| VF PC1B6 | Tamper-proof protection for device-side connector | ● Blue detectable technopolymer |
| VF PC2B6 | Tamper-proof protection for male - female connector | ● Blue detectable technopolymer |

Door holding magnets



| Article | Description |
|---------|--|
| SM H9ZF | Door holding magnet (holding force 40 N) |
| SM H9ZQ | Door holding magnet (holding force 40 N, opposite polarity to SM H9ZF) |

Holding magnets for use on machinery doors. The magnets are sealed inside a plastic cover and will not rust even in damp environments.

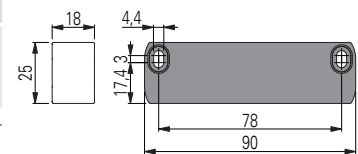

LED signalling lights

Packs of 5 pcs.



These signalling lights with high luminosity LEDs are used for signalling that an electric contact has changed its state inside the switch. They can be installed on switches of the FL, FX, FZ, FW, FG, FY, NG or FS series by screwing them on one of the conduit entries not used for electric cables. They can be used for many different purposes: for example, to signal, from a distance, whether the switch has been actuated; whether the guard has closed correctly; or whether the guard is locked or unlocked. The inner part can rotate in such a way that it can be wired and screwed on the switch without any risk of twisting the wires.

Features:

Protection degree:

IP67 acc. to EN 60529

Ambient temperature:

IP69K acc. to ISO 20653

Operating voltage U_n :

-25°C ... +70°C

24 Vac/dc (10 mA)

120 Vac (20 mA)

230 Vac (20 mA)

Tolerance on the supply voltages:

 $\pm 15\%$ of U_n

Operating current:

10 mA

Connection system:

PUSH-IN spring type

Cross-section of rigid/flexible wires w. wire-end sleeve:

min. 1 x 0.34 mm² (1 x AWG 24)max. 1 x 1.5 mm² (1 x AWG 16)

Wire cross-section with pre-insulated wire-end sleeve:

min. 1 x 0.34 mm² (1 x AWG 24)max. 1 x 0.75 mm² (1 x AWG 18)

Tightening torque:

1.2 ... 2 Nm

Wire stripping length (x):

min.: 8 mm

max.: 12 mm

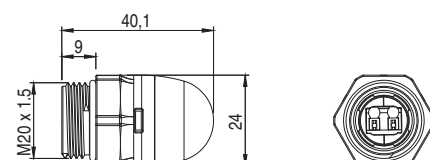
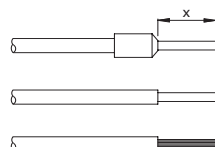

Application examples

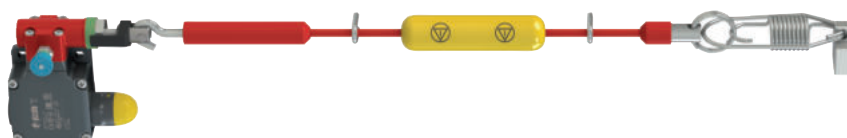

Status indicator for safety rope switches

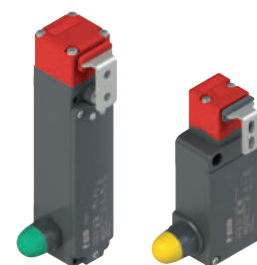

Indication of unlocked door

Code structure

Attention! The feasibility of a code number does not mean the effective availability of a product. Please contact our sales office

VF SL1A3PA1

Operating voltage

| | |
|----------|-----------|
| 1 | 24 Vac/dc |
| 3 | 120 Vac |
| 4 | 230 Vac |

Type of light source

| | |
|----------|------------------------------------|
| A | Standard LED with continuous light |
|----------|------------------------------------|

Body design

| | |
|----------|--|
| A | Total height 40 mm, spherical lens, threading M20x1.5 mm |
|----------|--|

Connection type

| | |
|----------|------------------------|
| P | PUSH-IN terminal strip |
|----------|------------------------|

Lens colour

| | |
|----------|--------|
| 2 | White |
| 3 | Red |
| 4 | Green |
| 5 | Yellow |

Stock items

| |
|-------------|
| VF SL1A3PA1 |
| VF SL1A5PA1 |

Fixing plates



Metal fixing plate, for fixing rope switches on the ceiling.
The plate is provided with bore holes for fastening switches of the FD, FL, FC, FP, FR, FM, FZ, FX, FK series. It is supplied without screws.

| Article | Description |
|---------|----------------------|
| VF SFP2 | Ceiling fixing plate |

Fixing plates



Fixing plate (complete with fastening screws) provided with long slots for adjusting the operating point.
Each plate is provided with two pairs of mounting holes, one for standard switches and one for switches with reset device. The actuator thus always has the same actuating point.

| Article | Description |
|---------|--------------------------|
| VF SFP1 | Fixing plate (FR series) |
| VF SFP3 | Fixing plate (FX series) |

Torx safety screws

Packs of **10 pcs.**



Pan head screws with Torx fitting and pin, stainless steel.
Use a thread locker where required for applications acc. to EN ISO 14119.

| Article | Description |
|----------------|--|
| VF VAM4X10BX-X | M4x10 screw, with Torx T20 fitting, AISI 304 |
| VF VAM4X15BX-X | M4x15 screw, with Torx T20 fitting, AISI 304 |
| VF VAM4X20BX-X | M4x20 screw, with Torx T20 fitting, AISI 304 |
| VF VAM4X25BX-X | M4x25 screw, with Torx T20 fitting, AISI 304 |
| VF VAM4X30BX-X | M4x30 screw, with Torx T20 fitting, AISI 304 |
| VF VAM5X10BX-X | M5x10 screw, with Torx T25 fitting, AISI 304 |
| VF VAM5X15BX-X | M5x15 screw, with Torx T25 fitting, AISI 304 |
| VF VAM5X20BX-X | M5x20 screw, with Torx T25 fitting, AISI 304 |
| VF VAM5X25BX-X | M5x25 screw, with Torx T25 fitting, AISI 304 |
| VF VAM5X35BX-X | M5x35 screw, with Torx T25 fitting, AISI 304 |
| VF VAM5X45BX-X | M5x45 screw, with Torx T25 fitting, AISI 304 |

OneWay safety screws

Packs of **10 pcs.**



Pan head screws with OneWay fitting in stainless steel.
This screw type cannot be removed or tampered with using common tools. Ideal for fixing safety device actuators in accordance with EN ISO 14119.

| Article | Description |
|----------------|--|
| VF VAM4X10BW-X | M4x10 screw, with OneWay fitting, AISI 304 |
| VF VAM4X15BW-X | M4x15 screw, with OneWay fitting, AISI 304 |
| VF VAM4X20BW-X | M4x20 screw, with OneWay fitting, AISI 304 |
| VF VAM4X25BW-X | M4x25 screw, with OneWay fitting, AISI 304 |
| VF VAM5X10BW-X | M5x10 screw, with OneWay fitting, AISI 304 |
| VF VAM5X15BW-X | M5x15 screw, with OneWay fitting, AISI 304 |
| VF VAM5X20BW-X | M5x20 screw, with OneWay fitting, AISI 304 |
| VF VAM5X25BW-X | M5x25 screw, with OneWay fitting, AISI 304 |

Bits for Torx safety screws

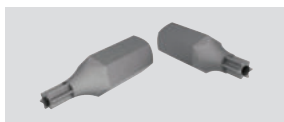

Bits for Torx safety screws with pin, with 1/4" hexagonal connection.

| Article | Description |
|-------------|--|
| VF VAIT1T20 | Bits for M4 screws with Torx T20 fitting |
| VF VAIT1T25 | Bits for M5 screws with Torx T25 fitting |
| VF VAIT1T30 | Bits for M6 screws with Torx T30 fitting |

Junction box for series connection of up to 4 devices

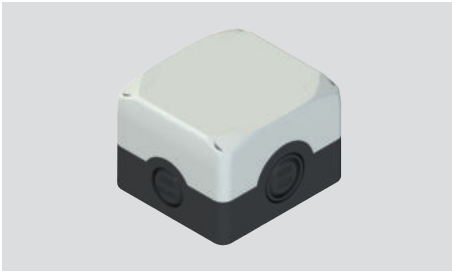

This accessory allows easy and precise series connection of up to 4 devices. Thanks to the numbered terminals and to the internal circuit, it is sufficient to connect the conductors in the slots provided with the practical and fast PUSH-IN spring connections. Thanks to the four internal microswitches, it is possible to easily and immediately direct the device signalling outputs (open or closed, locked or unlocked) to one of the four available auxiliary channels and then manage the information independently for each channel through a PLC.

Features:

- Material:** Self-extinguishing shock-proof polycarbonate with double insulation, UV-resistant and glass fibre reinforced
- Material of the screws:** Stainless steel
- Protection degree:** IP67 acc. to EN 60529, IP69K acc. to ISO 20653, with cable gland of equal or higher protection degree
- Conduit entries:** 2x M20 - 1/2 NPT knock-out side entries
2x M20 - 1/2 NPT - M25 knock-out side entries
2x M16 knock-out base entries
- Ambient temperature:** -40°C ... +80°C
- Tightening torque of the cover screws:** 1 ... 1.4 Nm
- Connection system:** PUSH-IN spring type
- Cross-section of rigid/flexible wires w. wire-end sleeve:** min. 1 x 0.34 mm² (1 x AWG 24)
max. 1 x 1.5 mm² (1 x AWG 16)
- Wire cross-section with pre-insulated wire-end sleeve:** min. 1 x 0.34 mm² (1 x AWG 24)
max. 1 x 0.75 mm² (1 x AWG 18)
- Wire stripping length (x):** min.: 8 mm
max.: 12 mm



Pin assignment

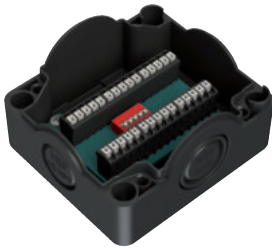
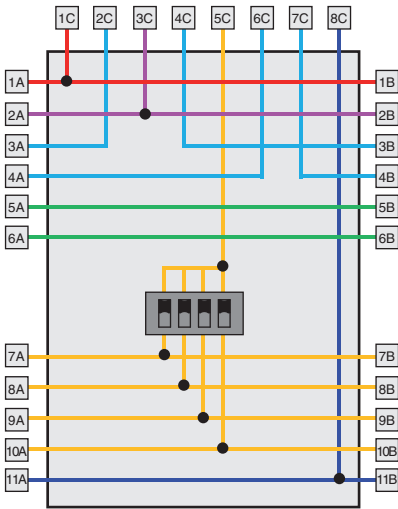

| Article | Description |
|------------|---|
| VF CY302P0 | Junction box for series connection of up to 4 devices |

| Terminal box | Connection | Terminal box | Connection |
|--------------|--|--------------|---|
| 1A / 1B | A1 Supply input +24 Vdc | 1C | A1 Supply input +24 Vdc |
| 2A / 2B | A2 Supply input 0 V | 2C | OS1 Safety output |
| 3A / 3B | OS1 / IS1 Safety output / safety input | 3C | A2 Supply input 0 V |
| 4A / 4B | OS2 / IS2 Safety output / safety input | 4C | IS1 Safety input |
| 5A / 5B | Auxiliary connection | 5C | O3 Signalling output, actuator inserted |
| 6A / 6B | Auxiliary connection | 6C | OS2 Safety output |
| 7A / 7B | OAU1 Auxiliary output Oaux1 | 7C | IS2 Safety input |
| 8A / 8B | OAU2 Auxiliary output Oaux2 | 8C | I4 Solenoid activation input |
| 9A / 9B | OAU3 Auxiliary output Oaux3 | | |
| 10A / 10B | OAU4 Auxiliary output Oaux4 | | |
| 11A / 11B | I4 Solenoid activation input | | |

Example of series connection of 4 NG series switches

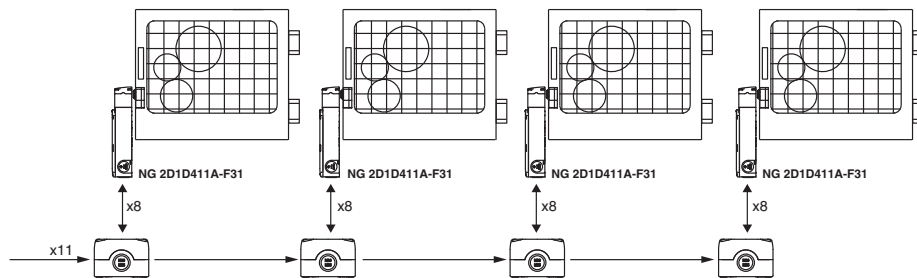

Wiring diagram

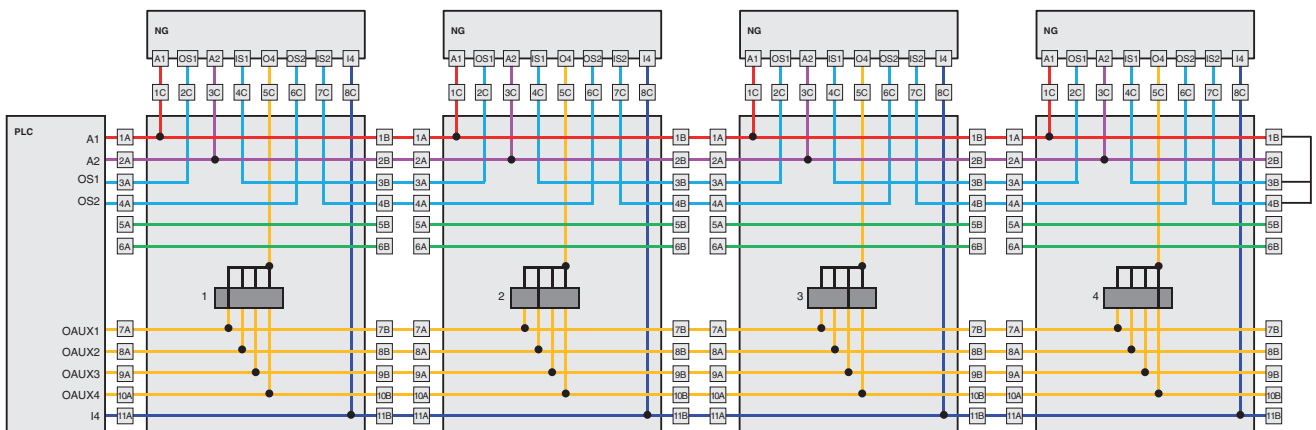

Minimum operating voltages and currents for reliable switching

The reliability of an electric contact depends on several factors, whose influence varies depending on the type of load. For high power loads is necessary for the contact to be able to dissipate the heat generated during switching. For low power loads, instead, it is important that it oxides and other impurities do not obstruct the passing of the electric signal. As a result, the material chosen for the electric contacts is a compromise among different and sometimes contrasting needs. In position switches contacts are usually made of a silver that has proved to be suitable for the switching of loads in the range of approximately 1 kW to 0.1 W. However, at lower loads, the effects of the oxide, which silver naturally develops upon contact with air, may occur; additionally to be taken into account are possible contaminations or impurities in the contact switching chamber (for example the talc powder in the cable sheaths that an installer could accidentally insert in the switch may have a similar effect).

It is impossible to define a fix threshold above which the “missing switching phenomenon” does not appear, because there are a lot of mechanical and electric parameters that influence this value. For example, in laboratory environment a good twin bridge electric contact is able to switch loads in the μW range for dozens of millions of handling operations, without losing signals. However, this does not mean that the same contact will have the same performance when the switch operates in environments with sudden changes of temperature (condensation) or where few switching occur (oxidation).

In order to avoid this kind of problem, gold plated contacts are used for very low loads profiting from the non-oxidability of this material. The gold-plating layer should be thick enough to be mechanically resistant to switching as well as electrically resistant to possible sparks that may vaporize it. For this reason Pizzato Elettrica uses micron thickness gold plating suitable for millions of working cycles. Thinner gold plating layers have often a purely aesthetic function and are only suitable to protect the product against oxidation during long time storage.

The minimum current and voltage values recommended by Pizzato Elettrica are shown in the diagram below, that is divided into two areas defined by a steady power limit. These values identify voltage and current combinations with high commutation reliability in most industrial fields. The lower voltage and current limits shown in the diagram are typical minimum values for industrial applications. They may also be reduced in non typical conditions. It is recommended, however, to always evaluate that the signal power to be switched is at least one magnitude order higher than the noise produced in the electric circuit, in particular when circuit cables are long and pass through areas with high electromagnetic fields and especially for powers lower than 10 mW.

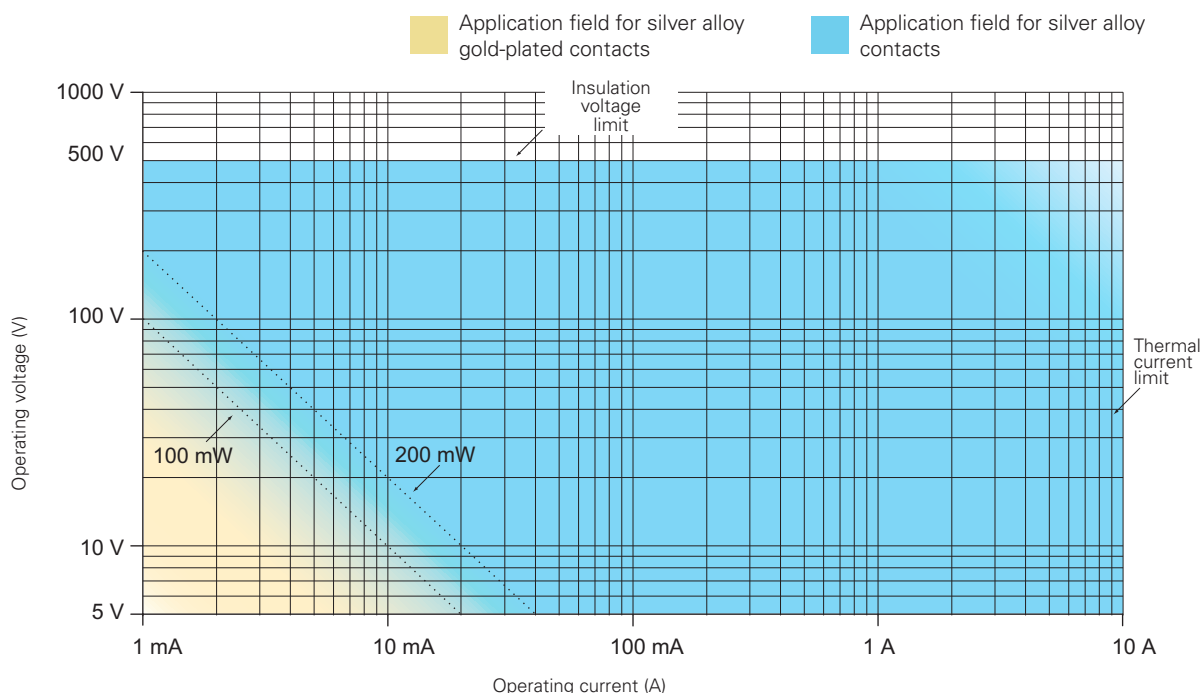

100 mW Recommended limit for general applications with snap action contact blocks with silver alloy contacts.

200 mW Recommended limit for general applications with slow action contact blocks with silver alloy contacts.

Wiring diagram for assembled connectors

For FR - FX series with technopolymer housing

| Contact block 2 1NO-1NC+1NO-1NC | | Contact block 5 1NO+1NC | | Contact block 6 1NO+1NC | | Contact block 7 1NO+1NC | | Contact block 9 2NC | | Contact block 10 2NO | |
|------------------------------------|---------|----------------------------|---------|----------------------------|---------|----------------------------|---------|------------------------|---------|-------------------------|---------|
| | | | | | | | | | | | |
| M12 connector, 8-pole | | M12 connector, 4-pole | | M12 connector, 4-pole | | M12 connector, 4-pole | | M12 connector, 4-pole | | M12 connector, 4-pole | |
| Contacts | Pin no. | Contacts | Pin no. | Contacts | Pin no. | Contacts | Pin no. | Contacts | Pin no. | Contacts | Pin no. |
| NO | 3-4 | NC | 1-2 | NC | 1-2 | NC | 1-2 | NC | 1-2 | NO | 1-2 |
| NC | 5-6 | NO | 3-4 | NO | 3-4 | NO | 3-4 | NC | 3-4 | NO | 3-4 |
| NC | 7-8 | | | | | | | | | | |
| NO | 1-2 | | | | | | | | | | |

| Contact block 11 2NC | | Contact block 12 2NO | | Contact block 13 2NC | | Contact block 14 2NC | | Contact block 15 2NO | | Contact block 16 2NC | |
|-------------------------|---------|-------------------------|---------|-------------------------|---------|-------------------------|---------|-------------------------|---------|-------------------------|---------|
| | | | | | | | | | | | |
| M12 connector, 4-pole | | M12 connector, 4-pole | | M12 connector, 4-pole | | M12 connector, 4-pole | | M12 connector, 4-pole | | M12 connector, 4-pole | |
| Contacts | Pin no. | Contacts | Pin no. | Contacts | Pin no. | Contacts | Pin no. | Contacts | Pin no. | Contacts | Pin no. |
| NC | 1-2 | NO | 1-2 | NC (1°) | 1-2 | NC (1°) | 1-2 | NO (1°) | 1-2 | NC, lever to the right | 1-2 |
| NC | 3-4 | NO | 3-4 | NC (2°) | 3-4 | NC (2°) | 3-4 | NO (2°) | 3-4 | NC, lever to the left | 3-4 |
| | | | | | | | | | | | |
| | | | | | | | | | | | |

| Contact block 18 1NO+1NC | | Contact block 20 2NC+1NO | | Contact block 21 3NC | | Contact block 22 1NC+2NO | | Contact block 33 1NC+1NO | | Contact block 34 2NC | |
|-----------------------------|---------|-----------------------------|---------|-------------------------|---------|-----------------------------|---------|-----------------------------|---------|-------------------------|---------|
| | | | | | | | | | | | |
| M12 connector, 4-pole | | M12 connector, 8-pole | | M12 connector, 8-pole | | M12 connector, 8-pole | | M12 connector, 4-pole | | M12 connector, 4-pole | |
| Contacts | Pin no. | Contacts | Pin no. | Contacts | Pin no. | Contacts | Pin no. | Contacts | Pin no. | Contacts | Pin no. |
| NC | 1-2 | NC | 3-4 | NC | 3-4 | NC | 3-4 | NC | 1-2 | NC | 1-2 |
| NO | 3-4 | NC | 5-6 | NC | 5-6 | NO | 5-6 | NO | 3-4 | NC | 3-4 |
| | | NO | 7-8 | NC | 7-8 | NO | 7-8 | | | | |
| | | | | | | | | | | | |

Definitions according to the EN 60947-1 and EN 60947-5-1 standards

Control switches

Devices or operating mechanisms for controlling the operation of equipment, including signalling, interlocking, etc.

Utilization category

Combination of specified requirements related to the conditions in which the switching device fulfils its purpose.

Operating cycle

Sequence of two operations, one for opening and one for closing.

Rated current I_e

This current depends on the rated operating voltage, the rated frequency, the utilization category and the type of protective enclosure, if present.

Thermal current I_{th}

Maximum current for heating tests on equipment without enclosure, in free air. Its value shall be least to equal to the maximum value of the rated operational current I_e of the equipment without enclosure, in eight-hour duty.

Electrical endurance

Number of on-load operating cycles, under the conditions defined by the corresponding product standard, which can be carried out without repair or replacement.

Mechanical endurance

Number of no-load operating cycles (i.e. without current on the main contacts), under the conditions defined by the corresponding product standard, which can be carried out without repair or replacement of mechanical parts.

Contact elements

The parts, fixed or movable, conducting or insulating, of a control switch necessary to close and open one single conducting path of a circuit.

Single interruption contact elements

Contact element opening or closing the circuit's conducting path at one point only.

Double interruption contact elements

Contact element opening or closing the circuit's conducting path at two points in series.

Make-contact elements (normally open)

Contact element closing a circuit's conducting path when the control switch is actuated.

Break-contact elements (normally closed)

Contact element opening a circuit's conducting path when the control switch is actuated.

Change-over contact elements

Contact element combination including one make-contact element and one break-contact element.

Electrically separated contact elements

Contact elements of the same control switch which are well isolated from each other and therefore can be connected to electric circuits with different voltages.

Contact elements with independent action (snap action)

Contact element of a manual or automatic device for control circuits where the motion speed of the contact is substantially independent from the motion speed of the actuator.

Contact elements with dependent action (slow action)

Contact element of a manual or automatic device for control circuits where the motion speed of the contact depends on the motion speed of the actuator.

Minimum actuating force

Minimum force to be applied to the actuator that will cause all contacts to reach their switched position.

Position switch

Control switch whose controller is actuated by a moving part of the machine, when this part arrives to a set position.

Foot switch

Control switch whose actuator is actuated by exerting force with a foot on the pedal.

Pre-travel of the actuator

The maximum travel of the actuator which does not cause any travel of the contact elements.

Ambient temperature

The air temperature surrounding the complete switching device, under prescribed conditions.

Rated operating voltage U_e

Voltage which, combined with the rated operational current I_e , determinates the application of the equipment and the referred utilization categories.

Rated insulation voltage U_i

Reference voltage for the dielectric test voltage and the creepage distances along surfaces.

Rated impulse withstand voltage U_{imp}

The highest peak value of an impulse voltage, of a prescribed shape and polarity, which does not cause destructive discharge under the specified test conditions.

Contact block

Contact element or contact elements combination which can be combined with similar units, operated by a common actuating system.

Markings and quality marks

CE marking



The CE marking is a mandatory declaration made by the manufacturer of a product in order to indicate that the product satisfies all requirements foreseen by the directives (regulated by the European Community) in terms of safety and quality. Therefore, it ensures National bodies of the EU countries about the fulfilment of obligations laid down in the agreements.

IMQ mark



The IMQ (Italian Institute of the Quality Mark) is an association in Italy (independent third body) whose task is to check and certify the compliance of materials and equipment with safety standards (CEI standards in the electric and electronic sector). This voluntary conformity certification is a guarantee of quality, safety and technical value.

UL mark



UL (Underwriters Laboratories Inc.) is an independent non-profit body that tests materials, devices, products, equipment, constructions, methods and systems with regard to their risk for human life and goods according to the standard in force in the United States and Canada. Decisions made by UL are often recognized by many governing authorities concerning the compliance with local safety regulations.

CCC mark



The CQC is the organization in the Chinese Popular Republic whose task is to check and certify the low voltage electrical material. This organization issues the product mark CCC which certifies the passing of electrical/mechanical conformity tests by products and the compliance of the company quality system with required standards. To obtain the mark, the Chinese body makes preliminary company visits as well as periodical check inspections. Position switches cannot be sold in the Chinese territory without this mark.

TÜV SÜD mark



TÜV SÜD is an international authority claiming long-standing experience in the certification of operating safety for electrical, electromechanical and electronic products. In the course of type approval, TÜV SÜD closely inspects the quality throughout all the stages concerning product development, from software design and completion, to production and to the tests conducted according to ISO/IEC standards. The operating safety certification is obtained voluntarily and has a high technical value, since it not only certifies the electrical safety of the product, but also its specific operating suitability for use in safety applications according to the IEC 61508 standard.

EAC mark



The EAC certificate of conformity is a certificate issued by a Customs Union certification body formed by Russia, Belarus and Kazakhstan, with which the conformity of a product is certified with the essential safety requirements laid down by one or more Technical Regulations (Directives) of the Customs Union.

ECOLAB mark



ECOLAB is one of the world's leading providers of technologies and services for hygiene in food processing. ECOLAB certifies the compatibility of tested electrical devices in its own laboratories, using disinfectants and cleaning agents used in the area of food processing worldwide.

UKCA mark



Following the withdrawal of the United Kingdom from the European Union, the UKCA mark (UKCA Conformity Assessment) takes the place of the CE marking for the British market (England, Scotland and Wales).

The UKCA mark indicates that the product satisfies the British regulations. As in the European Union, conformity can be achieved through the application of harmonised standards, the so-called "designated standards". The evaluation of the conformity can be performed through self-certification or through a certification process by an "approved body". At the time of printing this catalogue, the British government specified 1 January 2025 as the date from which the UKCA mark will be mandatory for products that are placed on the market in Great Britain.

International and European Standards

EN 50041: Low voltage switchgear and controlgear for industrial use. Control switches. Position switches 42.5x80 mm. Dimensions and features.

EN 50047: Low voltage switchgear and controlgear for industrial use. Control switches. Position switches 30x55 mm. Dimensions and features.

EN ISO 14119: Safety of machinery. Interlocking devices associated with guards. Design and selection principles.

EN ISO 12100: Safety of machinery. General design principles. Risk assessment and risk reduction.

EN ISO 13849-1: Safety of machinery. Safety-related parts of control systems. Part 1: General principles for design.

EN ISO 13850: Safety of machinery. Emergency stop devices, functional aspects. Design principles.

EN 61000-6-3 (equivalent to IEC 61000-6-3): Electromagnetic compatibility. Generic emission standard. Part 1: Residential, commercial and light-industrial environments.

EN 61000-6-2 (equivalent to IEC 61000-6-2): Electromagnetic compatibility. Generic immunity standard. Part 2: Industrial environments.

EN ISO 13855: Safety of machinery. Positioning of safeguards with respect to the approach speeds of parts of the human body.

EN ISO 14118: Safety of machinery. Prevention of unexpected start-up.

EN ISO 13851: Safety of machinery. Two-hand control devices. Principles for design and choice.

EN 60947-1 (equivalent to IEC 60947-1): Low-voltage switchgear and controlgear. Part 1: General rules.

EN 60947-5-1 (equivalent to IEC 60947-5-1): Low-voltage switchgear and controlgear. Part 5: Devices for control and operation circuits. Section 1: Electromechanical control circuit devices.

EN 60947-5-2: Low-voltage switchgear and controlgear. Part 5-2: Control circuit devices and switching elements - Proximity switches.

EN 60947-5-3: Low-voltage switchgear and controlgear. Part 5-3: Control circuit devices and switching elements - Requirements for proximity devices with defined behaviour under fault conditions (PDF).

EN 60204-1 (equivalent to IEC 60204-1): Safety of machinery. Electrical equipment of machines. Part 1: General rules.

EN 60529 (equivalent to IEC 60529): Protection degree of the housings (IP codes).

ISO 20653: Road vehicles-degrees of protection (IP CODE).

EN 62326-1 (equivalent to IEC 62326-1): Printed boards. Part 1: Generic specification.

EN 60664-1 (equivalent to IEC 60664-1): Insulation coordination for equipment within low-voltage systems. Part 1: Principles, requirements and tests.

EN 61508 (equivalent to IEC 61508): Functional safety of electrical, electronic and programmable electronic systems for safety applications.

EN 62061 (equivalent to IEC 62061): Safety of machinery - Functional safety of safety-related electrical, electronic and programmable electronic control systems.

EN 60079-0 (equivalent to IEC 60079-0): Explosive atmospheres - Part 0: Equipment - General requirements.

EN 60079-11 (equivalent to IEC 60079-11): Explosive atmospheres - Part 11: Equipment protection by intrinsic safety "i".

EN 60079-15 (equivalent to IEC 60079-15): Explosive atmospheres - Part 15: Equipment protection by type of protection "n".

EN 60079-31 (equivalent to IEC 60079-31): Explosive atmospheres - Part 31: Equipment dust ignition protection by enclosure "t".

EN IEC 63000: Technical documentation for the evaluation of electrical and electronic products in relation to the restriction of hazardous substances.

BG-GS-ET-15: Prescriptions about how to test switches with forced contact opening to be used in safety applications (German standard).

UL 508: Standards for industrial control equipment. (American standard).

CSA C22.2 No. 14: Standards for industrial control equipment. (Canadian standard).

European directives

| | |
|------------|---|
| 2014/35/EU | Directive on low-voltage switchgear and controlgear |
| 2006/42/EC | Machinery Directive |
| 2014/30/EU | Directive on electromagnetic compatibility |
| 2014/34/EU | ATEX Directive |
| 2011/65/UE | RoHS Directive |

Regulatory Organisations

| | | | |
|----------------|---|------------|--|
| CEI | Comitato Elettrotecnico Italiano (IT) | NF | Normes Françaises (FR) |
| CSA | Canadian Standard Association (CAN) | VDE | Verband Deutscher Elektrotechniker (DE) |
| CENELEC | European Committee for Electrotechnical Standardisation | UNI | Ente Nazionale Italiano di Unificazione (IT) |
| CEN | European Committee for Standardisation | UL | Underwriter's Laboratories (USA) |
| IEC | International Electrotechnical Commission | TÜV | Technischer Überwachungs-Verein (DE) |

Protection degree of housings for electrical material according to EN 60529

The following table reports the required protection degrees according to the IEC 60529, EN 60529, CEI 70-1 standards.

The protection degrees are indicated by the abbreviation IP and 2 following digits. 2 additional letters can be reported indicating protection of persons or other features. The first digit shows the degree of protection against penetration of external solid materials. The second digit identifies instead the protection degree against liquid penetration.

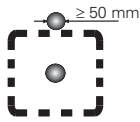
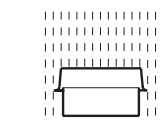
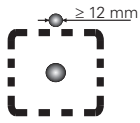
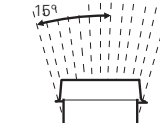
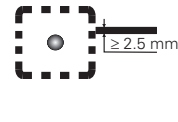
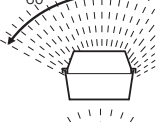
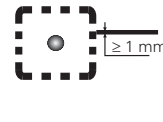
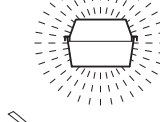
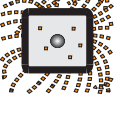
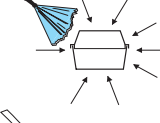
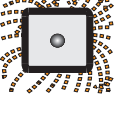
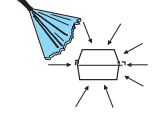
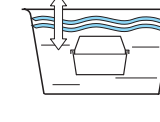
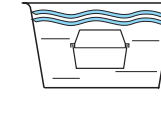
| 1st digit | Description | Protection for the machine | Protection for persons | 2nd digit | Description | Protection for the machine |
|-----------|---|---|---|-----------|---|---|
| 0 | | Not protected | Not protected | 0 | | Not protected |
| 1 |  | Protected against solid objects greater than 50 mm | Against access to hazardous parts with the back of a hand (Ø 50 mm) | 1 |  | Protected against vertically falling water drops |
| 2 |  | Protected against solid objects greater than 12 mm | Against access to hazardous parts with a finger (Ø 12 mm) | 2 |  | Protected against water drops falling at max. 15° angle |
| 3 |  | Protected against solid objects greater than 2.5 mm | Against access to hazardous parts with a tool (Ø 2.5 mm) | 3 |  | Protected against rain drops falling at max. 60° angle |
| 4 |  | Protected against solid objects greater than 1 mm | Against access to hazardous parts with a wire (Ø 1 mm) | 4 |  | Protected against splash water from any direction |
| 5 |  | Protected against dust | Against access to hazardous parts with a wire (Ø 1 mm) | 5 |  | Protected against water jets from any direction |
| 6 |  | Totally protected against dust | Against access to hazardous parts with a wire (Ø 1 mm) | 6 |  | Protected against powerful water jets from any direction (e.g. waves) |
| | | | | 7 |  | Protected against temporary water immersion (30 minutes at one-meter depth) |
| | | | | 8 |  | Protected against continuous immersion in water |

Protection degree IP69K according to ISO 20653

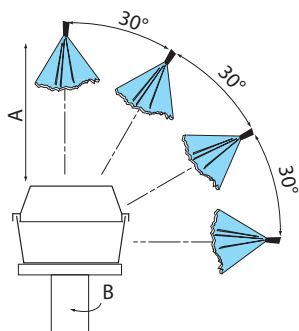

ISO 20653 envisages a particularly strenuous test. This test simulates the conditions of pressure washing in industrial environments with water jets having pressure between 80 and 100 bar, flow rate between 14 and 16 l/min. and a temperature of 80°C.

Test specifications:

| | |
|------------------------------|-------------------|
| Rotation speed (B): | 5 ± 1 rpm |
| Distance from water jet (A): | 100 +50/-0 mm |
| Water flow rate: | 15 ± 1 l/min |
| Water pressure: | 9000 ± 1000 kPa |
| Water temperature: | 80 ± 5 °C |
| Test duration: | 30 s per position |

Housing data in accordance with UL (UL 508) and CSA (C22-2 no.14) approvals

The features required for a housing are determined by a specific environmental designation and other features such as the kind of gasket or the use of solvent materials.

| Type | Intended use and description |
|------|--|
| 1 | Mainly for indoor utilization, supplied with protection against contact with the internal mechanism and against a limited quantity of falling dirt. |
| 4X | Suitable for both indoor and outdoor use, provided with protection degree against falling rain, water splashes and direct coming water from a pipe. No damage caused by ice formation on the housing. Corrosion-resistant. |
| 12 | Indoor utilization, provided with a protection degree against dust, dirt, flying fibres, dripping water and outside condensation of non-corrosive fluids. |
| 13 | Indoor utilization, supplied with a protection degree against gauze, dust penetration, outside condensation and sprinkling of water, oil and non-corrosive fluids. |

Pollution degree (of environmental conditions) according to EN 60947-1

According to the EN 60947-1 standard, the pollution degree is a conventional number based on the quantity of conducting hygroscopic dust, ionized gas or salt, and on the relative humidity and its frequency of occurrence resulting in hygroscopic absorption or condensation of moisture leading to reduction in dielectric strength and/or surface resistivity. In equipment to be used inside a housing or having an integral enclosure as part of the device, the pollution degree applies to the inner part of housing. With the purpose of evaluating the air and surface insulation distances, the following four pollution degrees are defined:

| Degree | Description |
|--------|--|
| 1 | No pollution or only dry and non-conductive pollution occurs. |
| 2 | Normally, only non-conductive pollution is present. Occasionally some temporary conductivity caused by condensation may occur. |
| 3 | Some conductive pollution is present, or some dry non-conductive pollution that becomes conductive because of condensation. |
| 4 | Pollution causes persistent conductivity, for instance due to conductive dust or rain or snow. |

Where not otherwise specified by the applicable standards for the product, equipment for industrial applications are generally intended for their use in environment with pollution degree 3. Nevertheless, other degrees can be considered, depending on the micro-environment or on particular applications.

Use in alternating and direct current of auxiliary devices acc. to EN 60947-5-1

| Alternating current use | | Direct current use | |
|-------------------------|---|----------------------|---|
| Utilization category | Intended use | Utilization category | Intended use |
| AC12 | Control of resistive loads and solid state loads with insulation by optocouplers. | DC12 | Control of resistive loads and solid state loads with insulation by optocouplers. |
| AC13 | Control of solid state loads with transformer isolation. | DC13 | Control of electromagnetic loads without economy resistors in circuit. |
| AC14 | Control of electromagnetic loads, power ≤ 72 VA. | DC14 | Control of electromagnetic loads with economy resistors in circuit. |
| AC15 | Control of electromagnetic loads, power ≥ 72 VA. | | |

Order procedures:

Purchasing orders must always be sent in writing (e-mail). We reserve the right to not accept e-mail orders in case of missing characteristics necessary to correctly identify the sender or to not process them in case of virus infected attachments or attachments of dubious origin.

Minimum billing amount:

Unless specifically agreed, the minimum billing amount is EUR 200 net (VAT excluded). For invoices of less than 200 Euro, a fee of 10 Euro will be charged if delivery is within the EU, or 30 Euro if delivery is outside the EU.

Invoices are issued weekly.

Prices:

The prices quoted in the price list do not include VAT, custom taxes or any other charges. Unless otherwise agreed, the prices quoted in the price list are not binding and may undergo changes without prior notice.

Order quantities:

Some products are shipped in packs. The ordered quantities of these items must be multiples of the quantities contained in the packages.

Order cancellation/changes:

Order changes might be accepted depending on the job order status. Changes or cancellation of special article orders will not be accepted. All terms and conditions stated in the order confirmation shall be deemed to be accepted without reservation after 2 working days from the date of the confirmation. What is stated in the customer's purchase order is not binding.

Supply:

The supply includes only what is expressly stated in the order confirmation. As per article 1461 of the Italian Civil Code, we reserve the right to stop supply in case of changes in the customer's financial standing.

Delivery:

The delivery is indicated in the order confirmation and reports the period in which the goods can be available at the factories of Pizzato Elettrica and not the date of arrival at the customer's premises. This date is an approximate value and cannot be used as a reason of the order non-fulfilment.

A list of items in stock can be found at www.pizzato.com

Packaging:

Packaging is free. For more than six boxes pallets can be necessary for the transport.

Shipment:

Unless expressly agreed between the parties, Pizzato Elettrica ships goods X works, in accordance with Incoterms® 2020 (published by the ICC). In the event that the customer requests transport against payment on the invoice, all parties agree that the goods always travel at the risk and peril of the customer. The customer must check that the forwarder delivers the number of boxes indicated in the delivery note, that the boxes are intact and that the weight corresponds to what is stated in the documents. In case of any inconsistencies, always accept the goods SUBJECT TO VERIFICATION, clearly specifying the type of damage. Any discrepancy or mistakes should be reported in writing within 8 days of receipt of the goods at info@pizzato.com.

Warranty:

The warranty has a validity of 12 months starting from the shipping date of the material. The warranty does not cover improper use of the material, negligence or wrong installation/assembling. The warranty does not cover parts subjected to wear or products used beyond the technological limits described in the catalogue, or items that have not received the right maintenance. Pizzato Elettrica engages itself to repair and/or replace parts or the complete product for those elements that present evident manufacturing defects, provided that they are still covered by warranty. Pizzato Elettrica is only responsible for the value of the product and requests for compensation due to machine downtime, repairs or costs for direct or indirect damages resulting from product malfunctions will not be accepted, even if these occur during the warranty period. It is the responsibility of the manufacturer to evaluate the importance of the products used and the possible damage caused by their malfunction and to adopt the necessary technical measures to minimize consequences on machines also for personal safety purposes (redundancy systems, self-controlled systems, etc). The warranty will be subject to the customer's compliance with the payment terms. Any samples provided free of charge or bearing the phrase "SAMPLE" must be considered as purely demonstrative and are not covered by the guarantee.

Products:

Products can be subjected to technical improvements in any moment without prior notice.

Payment terms:

Payments should be settled within the terms agreed in the order confirmation. The payment method is always at the risk of the buyer, regardless of the means chosen. In case of delayed payment, Pizzato Elettrica reserves the right to stop the delivery of any current orders and charge interest at the rate envisaged by European Directive 2011/7/EU. Any technical or commercial complaints do not entitle the claimant to suspend the due payments.

Returns:

Any products returned for any reason will not be accepted unless they are previously APPROVED and AUTHORISED in writing. Otherwise, Pizzato Elettrica reserves the right to reject the goods and return them "freight collect" at the expense of the buyer, in the same way by which they were forwarded. Returns have to be sent back within 3 months from the authorization date and no later. After this period, returns will not be accepted. The request to return goods will lead to their sales price being devalued and will be considered if relative to standard items and materials shipped no more than 12 months ago. The returned goods and the relative packaging must be intact and free from damage. The customer shall bear the packaging costs for returns.

Ownership:

The delivered products remain property of Pizzato Elettrica until full settlement of the invoices.

Proper Law:

The Court of Vicenza shall have jurisdiction in any disputes.

For the updated terms of sale, please consult the website www.pizzato.it

Notes

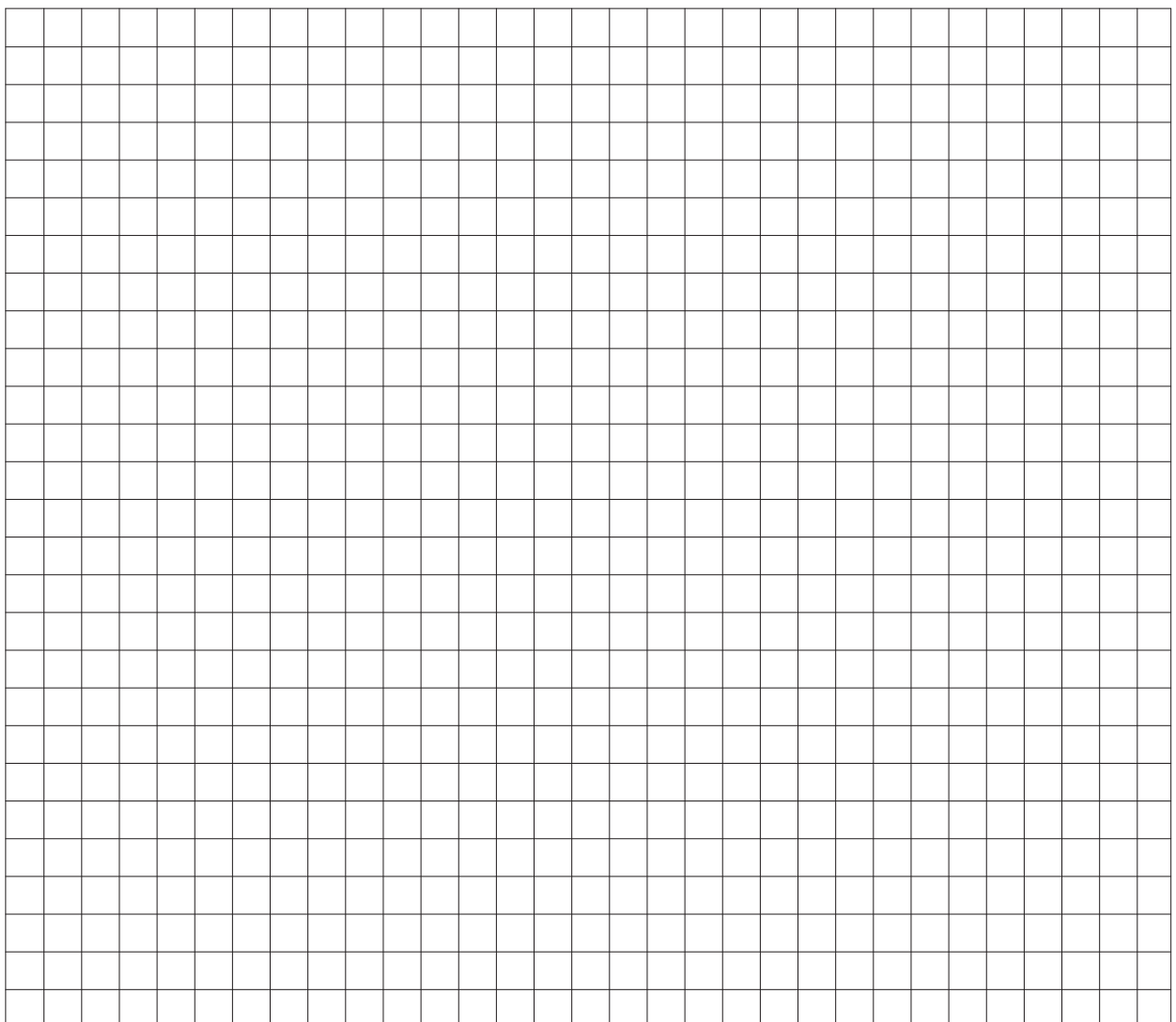



General Catalogue
Detection

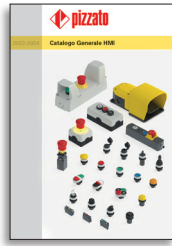

General Catalogue
HMI



General Catalogue
Safety



General Catalogue
Lift



Website
www.pizzato.com



PASSION FOR QUALITY

Pizzato Elettrica s.r.l. via Torino, 1 - 36063 Marostica (VI) Italy

Phone: +39 0424 470 930

E-mail: info@pizzato.com

Website: www.pizzato.com

ZE GCH05A24-ENG

